



US008712441B2

(12) **United States Patent**
Haney

(10) **Patent No.:** **US 8,712,441 B2**
(45) **Date of Patent:** **Apr. 29, 2014**

(54) **METHODS AND SYSTEMS FOR TEMPORARILY SHARING POSITION DATA BETWEEN MOBILE-DEVICE USERS**

(56) **References Cited**

U.S. PATENT DOCUMENTS

(71) Applicant: **X One, Inc.**, Livermore, CA (US)

1,103,073 A 7/1914 O'Connell
4,121,160 A 10/1978 Cataldo

(72) Inventor: **Richard D. Haney**, Union City, CA (US)

(Continued)

FOREIGN PATENT DOCUMENTS

(73) Assignee: **Xone, Inc.**, Union City, CA (US)

AU 2003901617 4/2003
AU 2003901795 4/2003

(*) Notice: Subject to any disclaimer, the term of this patent is extended or adjusted under 35 U.S.C. 154(b) by 0 days.

(Continued)

OTHER PUBLICATIONS

U.S. Appl. No. 60/574,988, filed May 26, 2004. First named inventor: Randolph A. Jaramillo. Entitled "Hot-Merchant Network (Mobile-Commerce or M-Merchant Network)."

(21) Appl. No.: **13/861,373**

(Continued)

(22) Filed: **Apr. 11, 2013**

Primary Examiner — Kwasi Karikari

(65) **Prior Publication Data**

(74) *Attorney, Agent, or Firm* — Silicon Edge Law Group LLP; Arthur J. Behiel

US 2013/0225205 A1 Aug. 29, 2013

(57) **ABSTRACT**

Related U.S. Application Data

A system for exchanging GPS or other position data between devices for purposes of group activities, child location monitoring, work group coordination, dispatching of employees etc. Cell phones and other wireless devices with GPS receivers have loaded therein a Buddy Watch application that communicates with a remote Buddy Watch Server. The server gets or maintains position data for the wireless devices. When the server receives a request from a first device to set up a temporary position-sharing relationship between it and a second device, the server facilitates symmetrical position sharing between the two devices. While the relationship is active, the server can receive updated position data from one or both devices, and if necessary calculate or recalculate a path based on the updated data. The server can also alert one of the devices should the other move too close to or too far from a specified location. The request message or messages used to establish the temporary position-sharing relationship may include a timeout specifying when the server is to sever the position-sharing relationship.

(60) Continuation of application No. 13/188,414, filed on Jul. 21, 2011, which is a division of application No. 12/075,408, filed on Mar. 11, 2008, now Pat. No. 8,538,458, which is a continuation of application No. 11/099,362, filed on Apr. 4, 2005, now Pat. No. 7,353,034.

(51) **Int. Cl.**
H04W 24/00 (2009.01)

(52) **U.S. Cl.**
USPC **455/456.3**; 455/404.2; 455/414.1;
455/414.2; 455/518; 455/519

(58) **Field of Classification Search**
USPC 455/404.2, 414.1, 414.2, 518, 519,
455/456.3

See application file for complete search history.

33 Claims, 51 Drawing Sheets

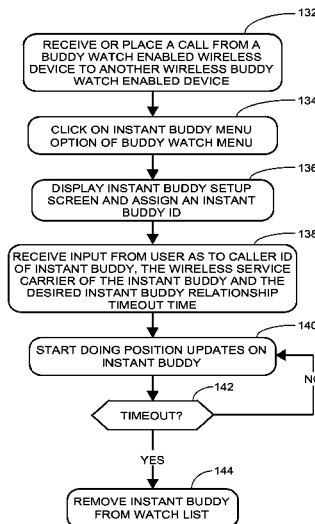

(56)

References Cited

U.S. PATENT DOCUMENTS

4,445,118	A	4/1984	Taylor et al.	5,299,132	A	3/1994	Wortham
4,494,119	A	1/1985	Wimbush	5,301,354	A	4/1994	Schwendeman et al.
4,606,073	A	8/1986	Moore	5,307,278	A	4/1994	Hermans et al.
4,644,351	A	2/1987	Zabarsky et al.	5,311,516	A	5/1994	Kuznicki et al.
4,651,156	A	3/1987	Martinez	5,317,311	A	5/1994	Martell et al.
4,701,601	A	10/1987	Francini et al.	5,325,302	A	6/1994	Izidon et al.
4,706,275	A	11/1987	Kamil	5,327,529	A	7/1994	Fults et al.
4,736,196	A	4/1988	McMahon et al.	5,334,974	A	8/1994	Simms et al.
4,799,062	A	1/1989	Sanderford, Jr. et al.	5,335,246	A	8/1994	Yokey et al.
4,818,998	A	4/1989	Apsell et al.	5,337,044	A	8/1994	Folger et al.
4,819,860	A	4/1989	Hargrove et al.	5,339,391	A	8/1994	Wroblewski et al.
4,868,376	A	9/1989	Lessin et al.	5,343,493	A	8/1994	Karimullah
4,884,132	A	11/1989	Morris et al.	5,347,568	A	9/1994	Moody et al.
4,891,638	A	1/1990	Davis	5,351,235	A	9/1994	Lahtinen
4,891,650	A	1/1990	Sheffer	5,361,212	A	11/1994	Class et al.
4,903,212	A	2/1990	Yokouchi et al.	5,363,425	A	11/1994	Mufti et al.
4,907,159	A	3/1990	Mauge et al.	5,365,451	A	11/1994	Wang et al.
4,910,767	A	3/1990	Brugliera et al.	5,371,678	A	12/1994	Nomura
4,939,662	A	7/1990	Nimura et al.	5,374,933	A	12/1994	Kao
4,952,928	A	8/1990	Carroll et al.	5,374,936	A	12/1994	Feng
4,972,484	A	11/1990	Theile et al.	5,379,057	A	1/1995	Clough et al.
4,980,913	A	12/1990	Skret	5,379,451	A	1/1995	Nakagoshi et al.
4,999,783	A	3/1991	Tenmoku et al.	5,381,338	A	1/1995	Wysocki et al.
5,014,040	A	5/1991	Weaver et al.	5,387,993	A	2/1995	Heller et al.
5,014,206	A	5/1991	Scribner et al.	5,388,147	A	2/1995	Grimes
5,021,794	A	6/1991	Lawrence	5,390,125	A	2/1995	Sennott et al.
5,031,104	A	7/1991	Ikeda et al.	5,390,339	A	2/1995	Bruckert et al.
5,039,980	A	8/1991	Aggers et al.	5,394,158	A	2/1995	Chia
5,043,736	A	8/1991	Darnell et al.	5,396,227	A	3/1995	Carroll et al.
5,045,839	A	9/1991	Ellis et al.	5,398,190	A	3/1995	Wortham
5,046,011	A	9/1991	Kakahara et al.	5,406,490	A	4/1995	Braegas
5,055,851	A	10/1991	Sheffer	5,406,614	A	4/1995	Hara
5,067,081	A	11/1991	Person	5,408,217	A	4/1995	Sanderford, Jr.
5,068,656	A	11/1991	Sutherland	5,412,388	A	5/1995	Attwood
5,068,891	A	11/1991	Marshall	5,414,432	A	5/1995	Penny, Jr. et al.
5,070,329	A	12/1991	Jasinaki	5,416,712	A	5/1995	Geier et al.
5,081,667	A	1/1992	Drori et al.	5,416,890	A	5/1995	Beretta
5,086,394	A	2/1992	Shapira	5,418,537	A	5/1995	Bird
5,119,104	A	6/1992	Heller	5,422,813	A	6/1995	Schuchman et al.
5,119,396	A	6/1992	Sanderford, Jr.	5,423,076	A	6/1995	Westergren et al.
5,126,941	A	6/1992	Gurmu et al.	5,432,841	A	7/1995	Rimer
5,128,752	A	7/1992	Von Kohorn	5,434,789	A	7/1995	Fraker et al.
5,144,283	A	9/1992	Arens et al.	5,438,321	A	8/1995	Bernard et al.
5,153,584	A	10/1992	Engira	5,442,557	A	8/1995	Kaneko
5,161,180	A	11/1992	Chavous	5,444,450	A	8/1995	Olds et al.
5,164,904	A	11/1992	Sumner	5,454,024	A	9/1995	Lebowitz
5,166,972	A	11/1992	Smith	5,457,689	A	10/1995	Marvit et al.
5,170,165	A	12/1992	Iihoshi et al.	5,457,713	A	10/1995	Sanderford, Jr. et al.
5,173,691	A	12/1992	Sumner	5,461,365	A	10/1995	Schlager et al.
5,177,478	A	1/1993	Wagai et al.	5,461,390	A	10/1995	Hoshen
5,177,479	A	1/1993	Cotton	5,469,362	A	11/1995	Hunt et al.
5,182,555	A	1/1993	Sumner	5,470,233	A	11/1995	Fruchterman et al.
5,187,810	A	2/1993	Yoneyama et al.	5,479,408	A	12/1995	Will
5,193,215	A	3/1993	Olmer	5,479,482	A	12/1995	Grimes
5,195,031	A	3/1993	Ordish	5,479,600	A	12/1995	Wroblewski et al.
5,208,756	A	5/1993	Song	5,485,161	A	1/1996	Vaughn
5,208,763	A	5/1993	Hong et al.	5,485,163	A	1/1996	Singer et al.
5,214,789	A	5/1993	George	5,488,563	A	1/1996	Chazelle et al.
5,218,367	A	6/1993	Sheffer et al.	5,497,149	A	3/1996	Fast
5,218,629	A	6/1993	Dumond, Jr. et al.	5,504,482	A	4/1996	Schreder
5,223,844	A	6/1993	Mansell et al.	5,506,886	A	4/1996	Maine et al.
5,227,874	A	7/1993	Von Kohorn	5,508,707	A	4/1996	LeBlanc et al.
5,239,570	A	8/1993	Koster et al.	5,508,931	A	4/1996	Snider
5,243,652	A	9/1993	Teare et al.	5,510,801	A	4/1996	Engelbrecht et al.
5,245,314	A	9/1993	Kah, Jr.	5,512,879	A	4/1996	Stokes
5,249,044	A	9/1993	Von Kohorn	5,513,243	A	4/1996	Kage
5,265,120	A	11/1993	Sanderford, Jr.	5,515,287	A	5/1996	Hakoyama et al.
5,266,944	A	11/1993	Carroll et al.	5,515,419	A	5/1996	Sheffer
5,274,560	A	12/1993	LaRue	5,517,199	A	5/1996	DiMattei
5,276,311	A	1/1994	Hennige	5,519,403	A	5/1996	Bickley et al.
5,283,570	A	2/1994	DeLuca et al.	5,519,760	A	5/1996	Borkowski et al.
5,289,527	A	2/1994	Tiedemann, Jr.	5,523,950	A	6/1996	Peterson
5,289,572	A	2/1994	Yano et al.	5,530,655	A	6/1996	Lokhoff et al.
5,293,642	A	3/1994	Lo	5,530,914	A	6/1996	McPheters
5,295,064	A	3/1994	Malec et al.	5,532,690	A	7/1996	Hertel
				5,535,434	A	7/1996	Siddoway et al.
				5,537,460	A	7/1996	Holliday, Jr. et al.
				5,539,395	A	7/1996	Buss et al.
				5,539,398	A	7/1996	Hall et al.

(56)

References Cited

U.S. PATENT DOCUMENTS

5,539,647	A	7/1996	Shibata et al.	5,712,899	A	1/1998	Pace, II
5,539,829	A	7/1996	Lokhoff et al.	5,717,392	A	2/1998	Eldridge
5,543,776	A	8/1996	L'Esperance et al.	5,721,781	A	2/1998	Deo et al.
5,543,789	A	8/1996	Behr et al.	5,724,660	A	3/1998	Kauser et al.
5,546,445	A	8/1996	Dennison et al.	5,727,057	A	3/1998	Emery et al.
5,548,726	A	8/1996	Pettus	5,731,757	A	3/1998	Layson, Jr.
5,552,772	A	9/1996	Janky et al.	5,731,785	A	3/1998	Lemelson et al.
5,552,989	A	9/1996	Bertrand	5,732,074	A	3/1998	Spaur et al.
5,555,286	A	9/1996	Tendler	5,732,354	A	3/1998	MacDonald
5,559,520	A	9/1996	Barzegar et al.	5,736,962	A	4/1998	Tendler
5,559,707	A	9/1996	DeLorme et al.	5,740,534	A	4/1998	Ayerst et al.
5,561,704	A	10/1996	Salimando	5,740,549	A	4/1998	Reilly et al.
5,561,799	A	10/1996	Khalidi et al.	5,742,233	A	4/1998	Hoffman et al.
5,568,119	A	10/1996	Schipper et al.	5,742,509	A	4/1998	Goldberg et al.
5,568,153	A	10/1996	Beliveau	5,742,635	A	4/1998	Sanderford, Jr.
5,570,412	A	10/1996	LeBlanc	5,742,666	A	4/1998	Alpert
5,574,648	A	11/1996	Pilley	5,745,865	A	4/1998	Rostoker et al.
5,574,772	A	11/1996	Scalisi et al.	5,748,109	A	5/1998	Kosaka et al.
5,579,372	A	11/1996	Astrom	5,752,186	A	5/1998	Malackowski et al.
5,579,535	A	11/1996	Orlen et al.	5,754,430	A	5/1998	Sawada
5,588,009	A	12/1996	Will	5,754,939	A	5/1998	Herz et al.
5,590,396	A	12/1996	Henry	5,758,049	A	5/1998	Johnson et al.
5,592,382	A	1/1997	Colley	5,758,257	A	5/1998	Herz et al.
5,592,535	A	1/1997	Klotz	RE35,829	E	6/1998	Sanderford, Jr.
5,594,780	A	1/1997	Wiedeman et al.	5,760,773	A	6/1998	Berman et al.
5,598,572	A	1/1997	Tanikoshi et al.	5,760,917	A	6/1998	Sheridan
5,604,486	A	2/1997	Lauro et al.	5,761,618	A	6/1998	Lynch et al.
5,606,313	A	2/1997	Allen et al.	5,764,686	A	6/1998	Sanderford et al.
5,606,618	A	2/1997	Lokhoff et al.	5,765,152	A	6/1998	Erickson
5,606,850	A	3/1997	Nakamura	5,767,795	A	6/1998	Schaphorst
5,610,815	A	3/1997	Gudat et al.	5,768,509	A	6/1998	Gunluk
5,614,890	A	3/1997	Fox	5,771,353	A	6/1998	Eggleston et al.
5,615,116	A	3/1997	Gudat et al.	5,774,170	A	6/1998	Hite et al.
5,617,074	A	4/1997	White	5,774,533	A	6/1998	Patel
5,619,571	A	4/1997	Sandstrom et al.	5,774,670	A	6/1998	Montulli
5,621,384	A	4/1997	Crimmins et al.	5,774,824	A	6/1998	Streit et al.
5,621,793	A	4/1997	Bednarek et al.	5,774,829	A	6/1998	Cisneros et al.
5,627,547	A	5/1997	Ramaswamy et al.	5,777,580	A	7/1998	Janky et al.
5,627,548	A	5/1997	Woo et al.	5,787,357	A	7/1998	Salin
5,627,549	A	5/1997	Park	5,793,630	A	8/1998	Theimer et al.
5,628,050	A	5/1997	McGraw et al.	5,794,142	A	8/1998	Vanttila et al.
5,628,051	A	5/1997	Salin	5,796,365	A	8/1998	Lewis
5,629,678	A	5/1997	Gargano et al.	5,796,613	A	8/1998	Kato et al.
5,629,693	A	5/1997	Janky	5,797,094	A	8/1998	Houde et al.
5,630,206	A	5/1997	Urban et al.	5,797,096	A	8/1998	Lupien et al.
5,633,912	A	5/1997	Tsoi	5,798,732	A	8/1998	Eshenbach
5,636,245	A	6/1997	Ernst et al.	5,802,492	A	9/1998	DeLorme et al.
5,636,276	A	6/1997	Brugger	5,805,460	A	9/1998	Greene et al.
5,642,303	A	6/1997	Small et al.	5,806,000	A	9/1998	Vo et al.
5,646,853	A	7/1997	Takahashi et al.	5,806,018	A	9/1998	Smith et al.
5,646,992	A	7/1997	Subler et al.	5,809,415	A	9/1998	Rossmann
5,650,770	A	7/1997	Schlager et al.	5,812,086	A	9/1998	Bertiger et al.
5,652,570	A	7/1997	Lepkofker	5,812,087	A	9/1998	Krasner
5,654,908	A	8/1997	Yokoyama	5,822,700	A	10/1998	Hult et al.
5,655,013	A	8/1997	Gainsboro	5,825,306	A	10/1998	Hiyokawa et al.
5,661,460	A	8/1997	Sallen et al.	5,825,884	A	10/1998	Zdępski et al.
5,661,652	A	8/1997	Sprague et al.	5,826,195	A	10/1998	Westerlage et al.
5,661,755	A	8/1997	Van De Kerkhof et al.	5,828,740	A	10/1998	Khuc et al.
5,663,732	A	9/1997	Stangeland et al.	5,831,552	A	11/1998	Sogawa et al.
5,666,215	A	9/1997	Fredlund et al.	5,835,061	A	11/1998	Stewart
5,675,362	A	10/1997	Clough et al.	5,835,907	A	11/1998	Newman
5,677,837	A	10/1997	Reynolds	5,839,086	A	11/1998	Hirano
5,682,525	A	10/1997	Bouve et al.	5,839,088	A	11/1998	Hancock et al.
5,682,600	A	10/1997	Salin	5,841,396	A	11/1998	Krasner
5,684,859	A	11/1997	Chanroo et al.	5,845,227	A	12/1998	Peterson
5,689,245	A	11/1997	Noreen et al.	5,848,373	A	12/1998	DeLorme et al.
5,689,252	A	11/1997	Ayanoglu et al.	5,852,775	A	12/1998	Hidary
5,689,270	A	11/1997	Kelley et al.	5,854,793	A	12/1998	Dinkins
5,689,431	A	11/1997	Rudow et al.	5,857,201	A	1/1999	Wright, Jr. et al.
5,697,058	A	12/1997	Paavonen	5,859,869	A	1/1999	Sanderford
5,699,053	A	12/1997	Jonsson	5,862,244	A	1/1999	Kleiner et al.
5,699,244	A	12/1997	Clark, Jr. et al.	5,864,667	A	1/1999	Barkan
5,704,029	A	12/1997	Wright, Jr.	5,867,110	A	2/1999	Naito et al.
5,708,478	A	1/1998	Tognazzini	5,870,686	A	2/1999	Monson
5,712,679	A	1/1998	Coles	5,872,526	A	2/1999	Tognazzini
				5,873,068	A	2/1999	Beaumont et al.
				5,874,914	A	2/1999	Krasner
				5,883,580	A	3/1999	Briancon et al.
				5,884,322	A	3/1999	Sidhu et al.

(56)

References Cited

U.S. PATENT DOCUMENTS

5,887,269	A	3/1999	Brunts et al.	5,991,827	A	11/1999	Ellenby et al.
5,890,064	A	3/1999	Widergen et al.	5,995,015	A	11/1999	DeTemple et al.
5,890,068	A	3/1999	Fattouche et al.	5,999,124	A	12/1999	Sheynblat
5,892,454	A	4/1999	Schipper et al.	5,999,126	A	12/1999	Ito
5,893,898	A	4/1999	Tanimoto	5,999,561	A	12/1999	Naden et al.
5,895,471	A	4/1999	King et al.	6,002,393	A	12/1999	Hite et al.
5,896,369	A	4/1999	Warsta et al.	6,002,932	A	12/1999	Kingdon et al.
5,898,680	A	4/1999	Johnstone et al.	6,002,936	A	12/1999	Roel-Ng et al.
5,899,954	A	5/1999	Sato	6,002,982	A	12/1999	Fry
5,905,248	A	5/1999	Russell et al.	6,004,061	A	12/1999	Manico et al.
5,905,451	A	5/1999	Sakashita	6,005,928	A	12/1999	Johnson
5,905,460	A	5/1999	Odagiri et al.	6,006,159	A	12/1999	Schmier et al.
5,908,465	A	6/1999	Ito et al.	6,006,260	A	12/1999	Barrick, Jr. et al.
5,910,799	A	6/1999	Carpenter et al.	6,009,409	A	12/1999	Adler et al.
5,913,040	A	6/1999	Rakavy et al.	6,009,410	A	12/1999	LeMole et al.
5,913,170	A	6/1999	Wortham	6,014,090	A	1/2000	Rosen et al.
5,914,668	A	6/1999	Chavez, Jr. et al.	6,014,602	A	1/2000	Kithil et al.
5,914,675	A	6/1999	Tognazzini	6,014,607	A	1/2000	Yagyu et al.
5,915,243	A	6/1999	Smolen	6,018,619	A	1/2000	Allard et al.
5,917,913	A	6/1999	Wang	6,018,718	A	1/2000	Walker et al.
5,918,180	A	6/1999	Dimino	6,023,653	A	2/2000	Ichimura et al.
5,920,589	A	7/1999	Rouquette et al.	6,026,304	A	2/2000	Hilsenrath et al.
5,920,821	A	7/1999	Seazholtz et al.	6,026,370	A	2/2000	Jermyn
5,922,074	A	7/1999	Richard et al.	6,026,375	A	2/2000	Hall et al.
5,923,861	A	7/1999	Bertram et al.	6,028,550	A	2/2000	Froeberg et al.
5,926,116	A	7/1999	Kitano et al.	6,029,069	A	2/2000	Takaki
5,926,765	A	7/1999	Sasaki	6,031,490	A	2/2000	Forssen et al.
5,930,250	A	7/1999	Klok et al.	6,032,051	A	2/2000	Hall et al.
5,930,699	A	7/1999	Bhatia	6,035,025	A	3/2000	Hanson
5,930,701	A	7/1999	Skog	6,041,280	A	3/2000	Kohli et al.
5,933,094	A	8/1999	Goss et al.	6,044,403	A	3/2000	Gerszberg et al.
5,933,100	A	8/1999	Golding	6,047,236	A	4/2000	Hancock et al.
5,933,811	A	8/1999	Angles et al.	6,047,327	A	4/2000	Tso et al.
5,936,572	A	8/1999	Loomis et al.	6,049,710	A	4/2000	Nilsson
5,937,037	A	8/1999	Kamel et al.	6,049,711	A	4/2000	Ben-Yehezkel et al.
5,937,392	A	8/1999	Alberts	6,049,778	A	4/2000	Walker et al.
5,938,721	A	8/1999	Dussell et al.	6,052,081	A	4/2000	Krasner
5,940,004	A	8/1999	Fulton	6,052,122	A	4/2000	Sutcliffe et al.
5,940,834	A	8/1999	Pinard et al.	6,052,645	A	4/2000	Harada
5,941,930	A	8/1999	Morimoto et al.	6,055,434	A	4/2000	Seraj
5,941,934	A	8/1999	Sato	6,058,300	A	5/2000	Hanson
5,943,399	A	8/1999	Bannister et al.	6,058,338	A	5/2000	Agashe et al.
5,945,944	A	8/1999	Krasner	6,058,350	A	5/2000	Ihara
5,946,618	A	8/1999	Agre et al.	6,061,018	A	5/2000	Sheynblat
5,946,626	A	8/1999	Foladare et al.	6,061,346	A	5/2000	Nordman
5,946,629	A	8/1999	Sawyer et al.	6,061,681	A	5/2000	Collins
5,946,630	A	8/1999	Willars et al.	6,064,335	A	5/2000	Eschenbach
5,946,646	A	8/1999	Schena et al.	6,064,336	A	5/2000	Krasner
5,948,040	A	9/1999	DeLorme et al.	6,064,398	A	5/2000	Ellenby et al.
5,948,041	A	9/1999	Abo et al.	6,064,875	A	5/2000	Morgan
5,948,061	A	9/1999	Merriman et al.	6,067,045	A	5/2000	Castelloe et al.
5,950,130	A	9/1999	Coursey	6,067,502	A	5/2000	Hayashida et al.
5,950,137	A	9/1999	Kim	6,069,570	A	5/2000	Herring
5,953,398	A	9/1999	Hill	6,070,067	A	5/2000	Nguyen et al.
5,955,973	A	9/1999	Anderson	6,073,013	A	6/2000	Agre et al.
5,959,577	A	9/1999	Fan et al.	6,073,062	A	6/2000	Hoshino et al.
5,959,580	A	9/1999	Maloney et al.	6,075,982	A	6/2000	Donovan et al.
5,959,623	A	9/1999	van Hoff et al.	6,076,041	A	6/2000	Watanabe
5,960,362	A	9/1999	Grob et al.	6,078,818	A	6/2000	Kingdon et al.
5,963,130	A	10/1999	Schlager et al.	6,081,206	A	6/2000	Kielland
5,964,821	A	10/1999	Brunts et al.	6,081,229	A	6/2000	Soliman et al.
5,966,696	A	10/1999	Giraud	6,081,508	A	6/2000	West et al.
5,968,109	A	10/1999	Israni et al.	6,081,803	A	6/2000	Ashby et al.
5,969,678	A	10/1999	Stewart	6,085,090	A	7/2000	Yee et al.
5,974,054	A	10/1999	Couts et al.	6,085,148	A	7/2000	Jamison et al.
5,978,685	A	11/1999	Laiho	6,085,320	A	7/2000	Kaliski, Jr.
5,978,747	A	11/1999	Craport et al.	6,087,965	A	7/2000	Murphy
5,978,768	A	11/1999	McGovern et al.	6,088,040	A	7/2000	Oda et al.
5,982,281	A	11/1999	Layson, Jr.	6,088,594	A	7/2000	Kingdon et al.
5,982,298	A	11/1999	Lappenbusch et al.	6,088,722	A	7/2000	Herz et al.
5,982,324	A	11/1999	Watters et al.	6,091,956	A	7/2000	Hollenberg
5,983,099	A	11/1999	Yao et al.	6,091,957	A	7/2000	Larkins et al.
5,987,323	A	11/1999	Huotari	6,092,076	A	7/2000	McDonough et al.
5,987,381	A	11/1999	Oshizawa	6,094,607	A	7/2000	Diesel
5,991,692	A	11/1999	Spencer, II et al.	6,097,958	A	8/2000	Bergen
				6,098,118	A	8/2000	Ellenby et al.
				6,100,806	A	8/2000	Gaukel
				6,101,378	A	8/2000	Barabash et al.
				6,101,443	A	8/2000	Kato et al.

(56)

References Cited

U.S. PATENT DOCUMENTS

6,104,090	A	8/2000	Unger et al.	6,188,909	B1	2/2001	Alanara et al.
6,104,931	A	8/2000	Havinis et al.	6,188,959	B1	2/2001	Schupfner
6,108,533	A	8/2000	Brohoff	6,189,098	B1	2/2001	Kaliski, Jr.
6,108,555	A	8/2000	Maloney et al.	6,195,557	B1	2/2001	Havinis et al.
6,108,709	A	8/2000	Shinomura et al.	6,195,609	B1	2/2001	Pilley et al.
6,111,541	A	8/2000	Karmel	6,195,646	B1	2/2001	Grosh et al.
6,111,911	A	8/2000	Sanderford, Jr. et al.	6,198,390	B1	3/2001	Schlager et al.
6,112,186	A	8/2000	Bergh et al.	6,198,431	B1	3/2001	Gibson
6,113,649	A	9/2000	Govindaraj	6,198,927	B1	3/2001	Wright et al.
6,115,481	A	9/2000	Wiens	6,199,014	B1	3/2001	Walker et al.
6,115,611	A	9/2000	Kimoto et al.	6,199,045	B1	3/2001	Giniger et al.
6,115,667	A	9/2000	Nakamura	6,199,099	B1	3/2001	Gershman et al.
6,115,680	A	9/2000	Coffee et al.	6,199,113	B1	3/2001	Alegre et al.
6,115,709	A	9/2000	Gilmour et al.	6,202,008	B1	3/2001	Beckert et al.
6,115,754	A	9/2000	Landgren	6,202,023	B1	3/2001	Hancock et al.
6,118,404	A	9/2000	Fernekes et al.	6,202,058	B1	3/2001	Rose et al.
6,119,014	A	9/2000	Alperovich et al.	6,204,812	B1	3/2001	Fattouche
6,119,098	A	9/2000	Guyot et al.	6,205,330	B1	3/2001	Winbladh
6,121,922	A	9/2000	Mohan	6,208,290	B1	3/2001	Krasner
6,122,503	A	9/2000	Daly	6,208,297	B1	3/2001	Fattouche et al.
6,122,520	A	9/2000	Want et al.	6,208,854	B1	3/2001	Roberts et al.
6,122,521	A	9/2000	Wilkinson et al.	6,208,857	B1	3/2001	Agre et al.
6,123,259	A	9/2000	Ogasawara	6,208,866	B1	3/2001	Rouhollahzadeh et al.
6,124,810	A	9/2000	Segal et al.	6,208,934	B1	3/2001	Bechtolsheim et al.
6,127,945	A	10/2000	Mura-Smith	6,212,392	B1	4/2001	Fitch et al.
6,128,482	A	10/2000	Nixon et al.	6,212,473	B1	4/2001	Stefan et al.
6,128,571	A	10/2000	Ito et al.	6,215,441	B1	4/2001	Moeglein et al.
6,128,599	A	10/2000	Walker et al.	6,216,086	B1	4/2001	Seymour et al.
6,131,028	A	10/2000	Whittington	6,219,557	B1	4/2001	Havinis
6,131,067	A	10/2000	Girerd et al.	6,222,483	B1	4/2001	Twitchell et al.
6,133,874	A	10/2000	Krasner	6,222,607	B1	4/2001	Szajewski et al.
6,133,876	A	10/2000	Fullerton et al.	6,222,939	B1	4/2001	Wiskott et al.
6,134,483	A	10/2000	Vayanos et al.	6,223,042	B1	4/2001	Raffel
6,134,548	A	10/2000	Gottzman et al.	6,223,046	B1	4/2001	Hamill-Keays et al.
6,138,003	A	10/2000	Kingdon et al.	6,223,122	B1	4/2001	Hancock et al.
6,138,142	A	10/2000	Linsk	6,226,529	B1	5/2001	Bruno et al.
6,140,957	A	10/2000	Wilson et al.	6,232,915	B1	5/2001	Dean et al.
6,141,347	A	10/2000	Shaughnessy et al.	6,233,430	B1	5/2001	Helferich
6,144,336	A	11/2000	Preston et al.	6,233,518	B1	5/2001	Lee
6,148,197	A	11/2000	Bridges et al.	6,236,365	B1	5/2001	LeBlanc et al.
6,148,198	A	11/2000	Anderson et al.	6,236,933	B1	5/2001	Lang
6,148,262	A	11/2000	Fry	6,239,742	B1	5/2001	Krasner
6,149,353	A	11/2000	Nilsson	6,240,069	B1	5/2001	Alperovich et al.
6,150,980	A	11/2000	Krasner	6,240,360	B1	5/2001	Phelan
6,151,309	A	11/2000	Busuioc et al.	6,240,425	B1	5/2001	Naughton
6,151,498	A	11/2000	Roel-Ng et al.	6,243,039	B1	6/2001	Elliot
6,154,152	A	11/2000	Ito	6,243,588	B1	6/2001	Koorapaty et al.
6,154,172	A	11/2000	Piccionelli et al.	6,243,657	B1	6/2001	Tuck et al.
6,154,658	A	11/2000	Caci	6,246,376	B1	6/2001	Bork et al.
6,157,381	A	12/2000	Bates et al.	6,246,861	B1	6/2001	Messier et al.
6,157,841	A	12/2000	Bolduc et al.	6,246,882	B1	6/2001	Lachance
6,157,935	A	12/2000	Tran et al.	6,246,948	B1	6/2001	Thakker
6,163,749	A	12/2000	McDonough et al.	6,247,135	B1	6/2001	Feague
6,166,627	A	12/2000	Reeley	6,249,252	B1	6/2001	Dupray
6,167,266	A	12/2000	Havinis et al.	6,249,282	B1	6/2001	Sutcliffe et al.
6,167,274	A	12/2000	Smith	6,249,680	B1	6/2001	Wax et al.
6,167,277	A	12/2000	Kawamoto	6,249,742	B1	6/2001	Friederich et al.
6,169,515	B1	1/2001	Mannings et al.	6,249,744	B1	6/2001	Morita
6,169,552	B1	1/2001	Endo et al.	6,249,772	B1	6/2001	Walker et al.
6,169,891	B1	1/2001	Gorham et al.	6,249,783	B1	6/2001	Crone et al.
6,169,901	B1	1/2001	Boucher	6,249,873	B1	6/2001	Richard et al.
6,169,902	B1	1/2001	Kawamoto	6,252,543	B1	6/2001	Camp
6,173,181	B1	1/2001	Losh	6,252,544	B1	6/2001	Hoffberg
6,175,740	B1	1/2001	Souissi et al.	6,253,091	B1	6/2001	Naddell et al.
6,175,922	B1	1/2001	Wang	6,253,203	B1	6/2001	O'Flaherty et al.
6,177,905	B1	1/2001	Welch	6,256,498	B1	7/2001	Ludwig
6,177,938	B1	1/2001	Gould	6,259,405	B1	7/2001	Stewart et al.
6,178,505	B1	1/2001	Schneider et al.	6,259,923	B1	7/2001	Lim et al.
6,178,506	B1	1/2001	Quick, Jr.	6,260,147	B1	7/2001	Quick, Jr.
6,181,934	B1	1/2001	Havinis et al.	6,266,014	B1	7/2001	Fattouche et al.
6,181,935	B1	1/2001	Gossman et al.	6,266,432	B1	7/2001	Wiens
6,184,829	B1	2/2001	Stilp	6,266,612	B1	7/2001	Dussell et al.
6,185,427	B1	2/2001	Krasner et al.	6,266,614	B1	7/2001	Alumbaugh
6,188,354	B1	2/2001	Soliman et al.	6,266,615	B1	7/2001	Jin
6,188,752	B1	2/2001	Lesley	6,269,343	B1	7/2001	Pallakoff
				6,272,231	B1	8/2001	Maurer et al.
				6,272,342	B1	8/2001	Havinis et al.
				6,272,467	B1	8/2001	Durand et al.
				6,275,692	B1	8/2001	Skog

(56)

References Cited

U.S. PATENT DOCUMENTS

6,275,849	B1	8/2001	Ludwig	6,370,475	B1	4/2002	Breed et al.
6,278,701	B1	8/2001	Ayyagari et al.	6,370,523	B1	4/2002	Anderson
6,278,884	B1	8/2001	Kim	6,370,629	B1	4/2002	Hastings et al.
6,281,807	B1	8/2001	Kynast et al.	6,373,430	B1	4/2002	Beason et al.
6,282,491	B1	8/2001	Bochmann et al.	6,374,176	B1	4/2002	Schmier et al.
6,282,496	B1	8/2001	Chowdhary	6,377,179	B1	4/2002	Fulton
6,286,005	B1	9/2001	Cannon	6,377,209	B1	4/2002	Krasner
6,288,716	B1	9/2001	Humpleman et al.	6,377,210	B1	4/2002	Moore
6,289,212	B1	9/2001	Stein et al.	6,377,793	B1	4/2002	Jenkins
6,289,373	B1	9/2001	Dezozno	6,377,810	B1	4/2002	Geiger et al.
6,292,671	B1	9/2001	Mansour	6,377,886	B1	4/2002	Gotou et al.
6,292,799	B1	9/2001	Peek et al.	6,381,465	B1	4/2002	Chern et al.
6,295,454	B1	9/2001	Havinis et al.	6,381,539	B1	4/2002	Shimazu
6,295,502	B1	9/2001	Hancock et al.	6,381,603	B1	4/2002	Chan et al.
6,297,768	B1	10/2001	Allen, Jr.	6,385,458	B1	5/2002	Papadimitriou et al.
6,298,306	B1	10/2001	Suarez et al.	6,385,465	B1	5/2002	Yoshioka
6,300,903	B1	10/2001	Richards et al.	6,385,535	B2	5/2002	Ohishi et al.
6,301,370	B1	10/2001	Steffens et al.	6,385,541	B1	5/2002	Blumberg et al.
6,304,758	B1	10/2001	Iierbig et al.	6,385,622	B2	5/2002	Bouve et al.
6,307,504	B1	10/2001	Sheynblat	6,389,288	B1	5/2002	Kuwahara et al.
6,308,269	B2	10/2001	Proidl	6,393,292	B1	5/2002	Lin
6,313,761	B1	11/2001	Shinada	6,396,819	B1	5/2002	Fleeter et al.
6,313,786	B1	11/2001	Sheynblat et al.	6,397,040	B1	5/2002	Titmuss et al.
6,314,365	B1	11/2001	Smith	6,397,057	B1	5/2002	Malackowski et al.
6,314,369	B1	11/2001	Ito et al.	6,397,208	B1	5/2002	Lee
6,314,406	B1	11/2001	O'Hagan et al.	6,397,219	B2	5/2002	Mills
6,317,029	B1	11/2001	Fleeter	6,400,270	B1	6/2002	Person
6,317,594	B1	11/2001	Gossman et al.	6,400,314	B1	6/2002	Krasner
6,317,604	B1	11/2001	Kovach, Jr. et al.	6,400,374	B2	6/2002	Lanier
6,317,684	B1	11/2001	Roeseler et al.	6,400,958	B1	6/2002	Isomursu et al.
6,317,718	B1	11/2001	Fano	6,401,032	B1	6/2002	Jamison et al.
6,321,091	B1	11/2001	Holland	6,404,388	B1	6/2002	Sollenberger et al.
6,321,092	B1	11/2001	Fitch et al.	6,404,408	B1	6/2002	Emerson, III
6,321,158	B1	11/2001	DeLorme et al.	6,405,034	B1	6/2002	Tijerino
6,321,250	B1	11/2001	Knape et al.	6,405,037	B1	6/2002	Rossmann
6,321,257	B1	11/2001	Kotola et al.	6,405,123	B1	6/2002	Rennard et al.
6,323,846	B1	11/2001	Westerman et al.	6,405,132	B1	6/2002	Breed et al.
6,324,542	B1	11/2001	Wright, Jr. et al.	6,408,307	B1	6/2002	Semple et al.
6,324,692	B1	11/2001	Fiske	6,408,309	B1	6/2002	Agarwal
6,326,918	B1	12/2001	Stewart	6,411,254	B1	6/2002	Moeglein et al.
6,327,473	B1	12/2001	Soliman et al.	6,411,899	B2	6/2002	Dussell et al.
6,327,479	B1	12/2001	Mikkola	6,414,629	B1	7/2002	Curcio
6,327,573	B1	12/2001	Walker et al.	6,414,635	B1	7/2002	Stewart et al.
6,327,580	B1	12/2001	Pierce et al.	6,415,207	B1	7/2002	Jones
6,330,452	B1	12/2001	Fattouche et al.	6,415,220	B1	7/2002	Kovacs
6,330,454	B1	12/2001	Verdonk	6,415,227	B1	7/2002	Lin
6,332,127	B1	12/2001	Bandera et al.	6,415,291	B2	7/2002	Bouve et al.
6,333,919	B2	12/2001	Gaffney	6,421,002	B2	7/2002	Krasner
6,339,437	B1	1/2002	Nielsen	6,421,669	B1	7/2002	Gilmour et al.
6,341,255	B1	1/2002	Lapidot	6,424,840	B1	7/2002	Fitch et al.
6,343,317	B1	1/2002	Glorikian	6,427,001	B1	7/2002	Contractor et al.
6,345,288	B1	2/2002	Reed et al.	6,427,115	B1	7/2002	Sekiyama
6,351,235	B1	2/2002	Stilp	6,427,120	B1	7/2002	Garin et al.
6,353,398	B1	3/2002	Amin et al.	6,430,409	B1	8/2002	Rossmann
6,353,743	B1	3/2002	Karmel	6,430,411	B1	8/2002	Lempio et al.
6,353,837	B1	3/2002	Blumenau	6,433,734	B1	8/2002	Krasner
6,356,192	B1	3/2002	Menard et al.	6,434,381	B1	8/2002	Moore et al.
6,356,543	B2	3/2002	Hall et al.	6,434,530	B1	8/2002	Sloane et al.
6,356,659	B1	3/2002	Wiskott et al.	6,438,490	B2	8/2002	Ohta
6,356,761	B1	3/2002	Huttunen et al.	6,442,241	B1	8/2002	Tsumpes
6,356,763	B1	3/2002	Kangas et al.	6,442,391	B1	8/2002	Johansson et al.
6,356,834	B2	3/2002	Hancock et al.	6,442,573	B1	8/2002	Schiller et al.
6,356,836	B1	3/2002	Adolph	6,449,473	B1	9/2002	Raivisto
6,356,838	B1	3/2002	Paul	6,449,476	B1	9/2002	Hutchison, IV et al.
6,359,557	B2	3/2002	Bilder	6,449,485	B1	9/2002	Anzil
6,360,093	B1	3/2002	Ross et al.	6,452,498	B2	9/2002	Stewart
6,360,101	B1	3/2002	Irvin	6,453,161	B1	9/2002	Touati et al.
6,360,102	B1	3/2002	Havinis et al.	6,456,234	B1	9/2002	Johnson
6,360,164	B1	3/2002	Murayama	6,456,852	B2	9/2002	Bar et al.
6,363,254	B1	3/2002	Jones et al.	6,456,854	B1	9/2002	Chern et al.
6,363,255	B1	3/2002	Kuwahara	6,456,956	B1	9/2002	Xiong
6,366,568	B1	4/2002	Bolgiano et al.	6,459,782	B1	10/2002	Bedrosian et al.
6,367,019	B1	4/2002	Ansell et al.	6,459,913	B2	10/2002	Cloutier
6,367,037	B1	4/2002	Remer et al.	6,462,675	B1	10/2002	Humphrey et al.
6,370,389	B1	4/2002	Isomursu et al.	6,463,142	B1	10/2002	Kilp
				6,463,272	B1	10/2002	Wallace et al.
				6,463,289	B1	10/2002	Havinis et al.
				6,466,695	B1	10/2002	Potzsch et al.
				6,469,664	B1	10/2002	Michaelson et al.

(56)

References Cited

U.S. PATENT DOCUMENTS

6,473,031	B1	10/2002	Harris	6,560,461	B1	5/2003	Fomukong et al.
6,473,790	B1	10/2002	Tagi	6,560,534	B2	5/2003	Abraham et al.
6,477,150	B1	11/2002	Maggenti et al.	6,560,588	B1	5/2003	Minter
6,477,363	B1	11/2002	Ayoub et al.	6,563,430	B1	5/2003	Kemink et al.
6,477,581	B1	11/2002	Carpenter et al.	6,563,459	B2	5/2003	Takenaga
6,480,713	B2	11/2002	Jenkins	6,563,950	B1	5/2003	Wiskott et al.
6,484,035	B2	11/2002	Allen, Jr.	6,564,047	B1	5/2003	Steele et al.
6,487,305	B2	11/2002	Kambe et al.	6,564,143	B1	5/2003	Alewine et al.
6,487,495	B1	11/2002	Gale et al.	6,564,261	B1	5/2003	Gudjonsson et al.
6,487,538	B1	11/2002	Gupta et al.	6,567,068	B2	5/2003	Rekimoto
6,490,454	B1	12/2002	Kangas et al.	6,570,530	B2	5/2003	Gaal et al.
6,490,519	B1	12/2002	Lapidot et al.	6,570,557	B1	5/2003	Westerman et al.
6,490,698	B1	12/2002	Horvitz et al.	6,571,095	B1	5/2003	Koodli
6,496,776	B1	12/2002	Blumberg et al.	6,571,279	B1	5/2003	Herz et al.
6,501,393	B1	12/2002	Richards et al.	6,574,484	B1	6/2003	Carley
6,501,421	B1	12/2002	Dutta et al.	6,574,558	B2	6/2003	Kohli
6,504,491	B1	1/2003	Christians	6,577,946	B2	6/2003	Myr
6,504,503	B1	1/2003	Saint-Hilaire et al.	6,578,079	B1	6/2003	Gittins
6,505,046	B1	1/2003	Baker	6,580,390	B1	6/2003	Hay
6,505,048	B1	1/2003	Moles et al.	6,580,811	B2	6/2003	Maurer et al.
6,505,049	B1	1/2003	Dorenbosch	6,580,914	B1	6/2003	Smith
6,505,123	B1	1/2003	Root et al.	6,581,072	B1	6/2003	Mathur et al.
6,507,802	B1	1/2003	Payton et al.	6,584,307	B1	6/2003	Antonucci et al.
6,509,830	B1	1/2003	Elliott	6,584,552	B1	6/2003	Kuno et al.
6,510,387	B2	1/2003	Fuchs et al.	6,587,688	B1	7/2003	Chambers et al.
6,512,455	B2	1/2003	Finn et al.	6,587,691	B1	7/2003	Granstam et al.
6,512,922	B1	1/2003	Burg et al.	6,587,782	B1	7/2003	Nocek et al.
6,512,930	B2	1/2003	Sandegren	6,587,835	B1	7/2003	Treyz et al.
6,515,575	B1	2/2003	Kataoka	6,590,533	B2	7/2003	Sollenberger et al.
6,515,623	B2	2/2003	Johnson	6,591,103	B1	7/2003	Dunn et al.
6,516,197	B2	2/2003	Havinis et al.	6,591,190	B2	7/2003	Nishida et al.
6,518,889	B2	2/2003	Schlager et al.	6,594,480	B1	7/2003	Montalvo et al.
6,519,241	B1	2/2003	Theimer	6,594,483	B2	7/2003	Nykanen et al.
6,519,463	B2	2/2003	Tendler	6,594,498	B1	7/2003	McKenna et al.
6,519,466	B2	2/2003	Pande et al.	6,594,500	B2	7/2003	Bender et al.
6,519,771	B1	2/2003	Zenith	6,594,576	B2	7/2003	Fan et al.
6,522,266	B1	2/2003	Soehren et al.	6,594,691	B1	7/2003	McCollum et al.
6,522,682	B1	2/2003	Kohli et al.	6,597,305	B2	7/2003	Szeto et al.
6,526,026	B1	2/2003	Menon	6,597,311	B2	7/2003	Sheynblat et al.
6,526,335	B1	2/2003	Treyz et al.	6,597,983	B2	7/2003	Hancock
6,526,352	B1	2/2003	Johnson et al.	6,600,919	B1	7/2003	Kawase
6,529,136	B2	3/2003	Cao et al.	6,600,927	B2	7/2003	Hamilton et al.
6,529,143	B2	3/2003	Mikkola et al.	6,601,046	B1	7/2003	Epstein
6,529,490	B1	3/2003	Oh et al.	6,601,060	B1	7/2003	Tomaru
6,529,500	B1	3/2003	Pandharipande	6,603,968	B2	8/2003	Anvekar et al.
6,529,722	B1	3/2003	Heinrich et al.	6,603,973	B1	8/2003	Foladare et al.
6,529,829	B2	3/2003	Turetzky et al.	6,606,495	B1	8/2003	Korpi et al.
6,531,982	B1	3/2003	White et al.	6,606,554	B2	8/2003	Edge
6,535,140	B1	3/2003	Goss et al.	6,608,556	B2	8/2003	De Moerloose et al.
6,538,757	B1	3/2003	Sansone	6,609,004	B1	8/2003	Morse et al.
6,539,200	B1	3/2003	Schiff	6,609,062	B2	8/2003	Hancock
6,539,232	B2	3/2003	Hendrey et al.	6,611,273	B2	8/2003	Stokes et al.
6,539,304	B1	3/2003	Chansarkar	6,611,498	B1	8/2003	Baker et al.
6,539,424	B1	3/2003	Dutta	6,611,687	B1	8/2003	Clark et al.
6,542,464	B1	4/2003	Takeda et al.	6,611,751	B2	8/2003	Warren
6,542,734	B1	4/2003	Abrol et al.	6,611,757	B2	8/2003	Brodie
6,542,743	B1	4/2003	Soliman	6,611,788	B1	8/2003	Hussa
6,542,748	B2	4/2003	Hendrey et al.	6,615,131	B1	9/2003	Rennard et al.
6,542,749	B2	4/2003	Tanaka et al.	6,615,134	B2	9/2003	Ando
6,542,750	B2	4/2003	Hendrey et al.	6,615,213	B1	9/2003	Johnson
6,542,812	B1	4/2003	Obradovich et al.	6,618,593	B1	9/2003	Drutman et al.
6,542,814	B2	4/2003	Polidi et al.	6,618,670	B1	9/2003	Chansarkar
6,542,819	B1	4/2003	Kovacs et al.	6,618,822	B1	9/2003	Loaiza et al.
6,546,360	B1	4/2003	Gilbert et al.	6,621,452	B2	9/2003	Knockeart et al.
6,549,522	B1	4/2003	Flynn	6,621,810	B1	9/2003	Leung
6,549,625	B1	4/2003	Rautila et al.	6,625,447	B1	9/2003	Rossmann
6,549,768	B1	4/2003	Fraccaroli	6,625,457	B1	9/2003	Raith
6,549,776	B1	4/2003	Joong	6,628,233	B2	9/2003	Knockeart et al.
6,549,844	B1	4/2003	Egberts	6,628,938	B1	9/2003	Rachabathuni et al.
6,552,682	B1	4/2003	Fan	6,629,104	B1	9/2003	Parulski et al.
6,553,236	B1	4/2003	Dunko et al.	6,629,136	B1	9/2003	Naidoo
6,553,310	B1	4/2003	Lopke	6,633,255	B2	10/2003	Krasner
6,556,832	B1	4/2003	Soliman	6,633,763	B2	10/2003	Yoshioka
6,560,323	B2	5/2003	Gainsboro	6,639,516	B1	10/2003	Copley
6,560,456	B1	5/2003	Lohitia et al.	6,639,939	B1	10/2003	Naden et al.
				6,640,184	B1	10/2003	Rabe
				6,647,257	B2	11/2003	Owensby
				6,647,269	B2	11/2003	Hendrey et al.
				6,650,284	B1	11/2003	Mannings et al.

(56)

References Cited

U.S. PATENT DOCUMENTS

6,650,288	B1	11/2003	Pitt et al.	6,731,236	B1	5/2004	Hager et al.
6,650,901	B1	11/2003	Schuster et al.	6,731,238	B2	5/2004	Johnson
6,650,902	B1	11/2003	Richton	6,731,940	B1	5/2004	Nagendran
6,650,997	B2	11/2003	Funk	6,734,821	B2	5/2004	van Diggelen
6,650,998	B1	11/2003	Rutledge et al.	6,735,568	B1	5/2004	Buckwalter et al.
6,657,661	B1	12/2003	Cazier	6,735,585	B1	5/2004	Black et al.
6,661,372	B1	12/2003	Girerd et al.	6,735,630	B1	5/2004	Gelvin et al.
6,661,409	B2	12/2003	Demartines et al.	6,737,989	B2	5/2004	Flick
6,662,023	B1	12/2003	Helle	6,738,013	B2	5/2004	Orler et al.
6,665,539	B2	12/2003	Sih et al.	6,738,635	B1	5/2004	Lewis et al.
6,665,541	B1	12/2003	Krasner et al.	6,738,800	B1	5/2004	Aquilon et al.
6,665,613	B2	12/2003	Duvall	6,738,808	B1	5/2004	Zellner et al.
6,665,715	B1	12/2003	Houri	6,741,188	B1	5/2004	Miller et al.
6,667,963	B1	12/2003	Rantalainen et al.	6,741,842	B2	5/2004	Goldberg et al.
6,671,377	B1	12/2003	Havinis et al.	6,741,926	B1	5/2004	Zhao et al.
6,671,620	B1	12/2003	Garin et al.	6,744,856	B2	6/2004	Karnik et al.
6,671,695	B2	12/2003	McFadden	6,744,858	B1	6/2004	Ryan et al.
6,671,698	B2	12/2003	Pickett et al.	6,745,038	B2	6/2004	Callaway, Jr. et al.
6,674,849	B1	1/2004	Froeberg	6,747,556	B2	6/2004	Medema et al.
6,675,012	B2	1/2004	Gray	6,747,596	B2	6/2004	Orler et al.
6,675,014	B1	1/2004	Sundquist	6,748,195	B1	6/2004	Phillips
6,677,894	B2	1/2004	Sheynblat et al.	6,748,225	B1	6/2004	Kepler
6,678,357	B2	1/2004	Stumer et al.	6,748,226	B1	6/2004	Wortham
6,678,516	B2	1/2004	Nordman et al.	6,748,318	B1	6/2004	Jones
6,680,694	B1	1/2004	Knockeart et al.	6,750,813	B2	6/2004	Vargas-Hurlston et al.
6,680,695	B2	1/2004	Turetzky et al.	6,750,883	B1	6/2004	Parupudi et al.
6,681,107	B2	1/2004	Jenkins et al.	6,751,464	B1	6/2004	Burg et al.
6,681,114	B2	1/2004	Chang et al.	6,751,626	B2	6/2004	Brown et al.
6,681,120	B1	1/2004	Kim	6,754,636	B1	6/2004	Walker et al.
6,683,538	B1	1/2004	Wilkes, Jr.	6,754,904	B1	6/2004	Cooper et al.
6,684,250	B2	1/2004	Anderson et al.	6,756,913	B1	6/2004	Ayed
6,684,269	B2	1/2004	Wagner	6,756,938	B2	6/2004	Zhao et al.
6,687,360	B2	2/2004	Kung et al.	6,757,156	B2	6/2004	Adams et al.
6,687,504	B1	2/2004	Raith	6,757,517	B2	6/2004	Chang
6,687,608	B2	2/2004	Sugimoto et al.	6,757,544	B2	6/2004	Rangarajan et al.
6,687,734	B1	2/2004	Sellink et al.	6,757,545	B2	6/2004	Nowak et al.
6,690,268	B2	2/2004	Schofield et al.	6,759,956	B2	7/2004	Menard et al.
6,690,322	B2	2/2004	Shamoto et al.	6,759,960	B2	7/2004	Stewart
6,691,114	B1	2/2004	Nakamura	6,762,772	B1	7/2004	Imamura et al.
6,691,155	B2	2/2004	Gottfried	6,765,492	B2	7/2004	Harris
6,693,586	B1	2/2004	Walters et al.	6,765,998	B2	7/2004	Bruce et al.
6,694,258	B2	2/2004	Johnson et al.	6,766,174	B1	7/2004	Kenyon
6,694,352	B1	2/2004	Omoigui	6,766,245	B2	7/2004	Padmanabhan
6,694,387	B2	2/2004	Wagner	6,768,944	B2	7/2004	Breed et al.
6,697,018	B2	2/2004	Stewart	6,769,002	B2	7/2004	Ayan
6,697,629	B1	2/2004	Grilli et al.	6,771,742	B2	8/2004	McCalmont et al.
6,697,731	B2	2/2004	Takayama et al.	6,771,971	B2	8/2004	Smith
6,697,734	B1	2/2004	Suomela	6,772,213	B2	8/2004	Glorikian
6,698,020	B1	2/2004	Zigmond et al.	6,772,340	B1	8/2004	Peinado et al.
6,700,534	B2	3/2004	Harris	6,774,797	B2	8/2004	Freathy et al.
6,701,144	B2	3/2004	Kirbas et al.	6,775,255	B1	8/2004	Roy
6,701,307	B2	3/2004	Himmelstein et al.	6,775,267	B1	8/2004	Kung et al.
6,703,971	B2	3/2004	Pande et al.	6,775,534	B2	8/2004	Lindgren et al.
6,703,972	B2	3/2004	van Diggelen	6,775,613	B2	8/2004	Burt et al.
6,704,651	B2	3/2004	van Diggelen	6,775,655	B1	8/2004	Peinado et al.
6,707,421	B1	3/2004	Drury et al.	6,775,802	B2	8/2004	Gaal
6,707,581	B1	3/2004	Browning	6,778,136	B2	8/2004	Gronemeyer
6,711,408	B1	3/2004	Raith	6,778,885	B2	8/2004	Agashe et al.
6,711,474	B1	3/2004	Treyz et al.	6,781,963	B2	8/2004	Crockett et al.
6,714,661	B2	3/2004	Buddenmeier et al.	6,782,264	B2	8/2004	Anderson
6,714,791	B2	3/2004	Friedman	6,782,278	B2	8/2004	Chen et al.
6,714,793	B1	3/2004	Carey et al.	6,788,199	B2	9/2004	Crabtree et al.
6,714,797	B1	3/2004	Rautila	6,788,249	B1	9/2004	Farmer et al.
6,718,174	B2	4/2004	Vayanos	6,788,288	B2	9/2004	Ano
6,718,344	B2	4/2004	Hirono	6,788,946	B2	9/2004	Winchell et al.
6,718,503	B1	4/2004	Lerner et al.	6,789,012	B1	9/2004	Childs et al.
6,720,915	B2	4/2004	Sheynblat	6,789,102	B2	9/2004	Gotou et al.
6,720,920	B2	4/2004	Breed et al.	6,795,444	B1	9/2004	Vo et al.
6,721,572	B1	4/2004	Smith et al.	6,795,686	B2	9/2004	Master et al.
6,721,578	B2	4/2004	Miner et al.	6,795,699	B1	9/2004	McCraw et al.
6,721,871	B2	4/2004	Piispanen et al.	6,795,700	B2	9/2004	Karaoguz et al.
6,724,342	B2	4/2004	Bloebaum et al.	6,795,710	B1	9/2004	Creemer
6,724,382	B2	4/2004	Kenyon et al.	6,795,770	B1	9/2004	Hanshew et al.
6,725,159	B2	4/2004	Krasner	6,798,358	B2	9/2004	Joyce et al.
6,728,701	B1	4/2004	Stoica	6,799,032	B2	9/2004	McDonnell et al.
				6,799,049	B1	9/2004	Zellner et al.
				6,799,050	B1	9/2004	Krasner
				6,801,159	B2	10/2004	Swope et al.
				6,801,763	B2	10/2004	Elsey et al.

(56)

References Cited

U.S. PATENT DOCUMENTS

6,801,778	B2	10/2004	Koorapaty et al.	6,867,733	B2	3/2005	Sandhu et al.
6,801,850	B1	10/2004	Wolfson	6,867,734	B2	3/2005	Voor et al.
6,801,855	B1	10/2004	Walters et al.	6,868,074	B1	3/2005	Hanson
6,804,524	B1	10/2004	Vandermeijden	6,868,333	B2	3/2005	Melen
6,804,657	B1	10/2004	Sultan	6,868,396	B2	3/2005	Smith et al.
6,804,726	B1	10/2004	Ellenby et al.	6,871,144	B1	3/2005	Lee
6,806,813	B1	10/2004	Cheng et al.	6,873,850	B2	3/2005	Dowling et al.
6,806,830	B2	10/2004	Panasik et al.	6,873,851	B2	3/2005	Brown et al.
6,807,479	B2	10/2004	Watanabe et al.	6,873,854	B2	3/2005	Crockett et al.
6,807,534	B1	10/2004	Erickson	6,876,734	B1	4/2005	Summers et al.
6,810,323	B1	10/2004	Bullock et al.	6,879,244	B1	4/2005	Scalisi
6,812,851	B1	11/2004	Dukach et al.	6,879,574	B2	4/2005	Naghian et al.
6,812,888	B2	11/2004	Drury et al.	6,879,835	B2	4/2005	Greene et al.
6,813,264	B2	11/2004	Vassilovski	6,879,838	B2	4/2005	Rankin et al.
6,813,346	B2	11/2004	Gruchala et al.	6,882,313	B1	4/2005	Fan et al.
6,813,395	B1	11/2004	Kinjo	6,882,348	B2	4/2005	Hirono
6,813,501	B2	11/2004	Kinnunen et al.	6,882,850	B2	4/2005	McConnell et al.
6,813,503	B1	11/2004	Zillikens et al.	6,885,874	B2	4/2005	Grube et al.
6,813,560	B2	11/2004	van Diggelen et al.	6,885,940	B2	4/2005	Brodie et al.
6,816,111	B2	11/2004	Krasner	6,886,750	B2	5/2005	Rathus et al.
6,816,580	B2	11/2004	Timmins	6,888,497	B2	5/2005	King et al.
6,816,710	B2	11/2004	Krasner	6,888,536	B2	5/2005	Westerman et al.
6,816,719	B1	11/2004	Heinonen et al.	6,888,932	B2	5/2005	Snip et al.
6,816,734	B2	11/2004	Wong et al.	6,891,500	B2	5/2005	Hall et al.
6,816,782	B1	11/2004	Walters et al.	6,895,238	B2	5/2005	Newell et al.
6,816,850	B2	11/2004	Culliss	6,895,249	B2	5/2005	Gaal
6,819,267	B1	11/2004	Edmark et al.	6,898,416	B2	5/2005	Saarinen et al.
6,819,919	B1	11/2004	Tanaka	6,898,436	B2	5/2005	Crockett et al.
6,820,269	B2	11/2004	Baucke et al.	6,898,516	B2	5/2005	Pechatnikov et al.
6,823,188	B1	11/2004	Stern	6,898,518	B2	5/2005	Padmanabhan
6,823,189	B2	11/2004	Akhteruzzaman et al.	6,898,526	B2	5/2005	Doyle et al.
6,823,257	B2	11/2004	Clapper	6,900,758	B1	5/2005	Mann et al.
6,826,473	B1	11/2004	Burch et al.	6,901,260	B1	5/2005	Xin
6,826,598	B1	11/2004	Titmuss et al.	6,901,304	B2	5/2005	Swan et al.
6,826,607	B1	11/2004	Gelvin et al.	6,901,444	B1	5/2005	Brelin
6,828,908	B2	12/2004	Clark	6,903,684	B1	6/2005	Simic et al.
6,829,475	B1	12/2004	Lee et al.	6,903,685	B1	6/2005	Arndt et al.
6,829,532	B2	12/2004	Obradovich et al.	6,904,029	B2	6/2005	Fors et al.
6,832,251	B1	12/2004	Gelvin et al.	6,904,360	B2	6/2005	Pechatnikov et al.
6,832,373	B2	12/2004	O'Neill	6,904,364	B2	6/2005	Randazzo et al.
6,834,115	B2	12/2004	Maurer et al.	6,907,224	B2	6/2005	Younis
6,834,195	B2	12/2004	Brandenberg et al.	6,907,238	B2	6/2005	Leung
6,839,020	B2	1/2005	Geier et al.	6,909,902	B1	6/2005	Sawada et al.
6,839,021	B2	1/2005	Sheynblat et al.	6,912,230	B1	6/2005	Salkini et al.
6,839,417	B2	1/2005	Weisman et al.	6,912,395	B2	6/2005	Benes et al.
6,839,561	B2	1/2005	Kato	6,912,398	B1	6/2005	Domnitz
6,839,628	B1	1/2005	Tu	6,912,545	B1	6/2005	Lundy et al.
6,842,620	B2	1/2005	Smith et al.	6,914,626	B2	7/2005	Squibbs
6,842,715	B1	1/2005	Gaal	6,915,208	B2	7/2005	Garin et al.
6,842,774	B1	1/2005	Piccioni	6,917,331	B2	7/2005	Gronemeyer
6,845,318	B1	1/2005	Moore et al.	6,917,703	B1	7/2005	Steffens et al.
6,845,400	B2	1/2005	Macpherson et al.	6,917,878	B2	7/2005	Pechatnikov et al.
6,847,376	B2	1/2005	Engeldrum et al.	6,917,968	B2	7/2005	Nakamura
6,847,618	B2	1/2005	Laursen et al.	6,920,328	B2	7/2005	Wollrab
6,847,822	B1	1/2005	Dennison et al.	6,920,391	B2	7/2005	Daubert et al.
6,847,891	B2	1/2005	Pietras et al.	6,920,430	B1	7/2005	Berton et al.
6,847,969	B1	1/2005	Mathai et al.	6,920,464	B2	7/2005	Fox
6,848,542	B2	2/2005	Gailey et al.	6,925,378	B2	8/2005	Tzamaloukas
6,850,188	B1	2/2005	Lee et al.	6,928,294	B2	8/2005	Maggenti et al.
6,850,209	B2	2/2005	Mankins et al.	6,930,634	B2	8/2005	Peng et al.
6,850,837	B2	2/2005	Paulauskas et al.	6,933,841	B2	8/2005	Muramatsu et al.
6,853,332	B1	2/2005	Brookes	6,934,634	B1	8/2005	Ge
6,853,911	B1	2/2005	Sakarya	6,937,187	B2	8/2005	van Diggelen et al.
6,853,916	B2	2/2005	Fuchs et al.	6,937,569	B1	8/2005	Sarkar et al.
6,853,917	B2	2/2005	Miwa	6,937,597	B1	8/2005	Rosenberg et al.
6,853,955	B1	2/2005	Burrell et al.	6,937,872	B2	8/2005	Krasner
6,856,282	B2	2/2005	Mauro et al.	6,938,076	B2	8/2005	Meyer et al.
6,859,149	B1	2/2005	Ohta et al.	6,940,454	B2	9/2005	Paetzold et al.
6,859,721	B1	2/2005	Runquist et al.	6,940,826	B1	9/2005	Simard et al.
6,859,831	B1	2/2005	Gelvin et al.	6,940,950	B2	9/2005	Dickinson et al.
6,861,980	B1	3/2005	Rowitch et al.	6,941,144	B2	9/2005	Stein
6,865,171	B1	3/2005	Nilsson	6,943,671	B2	9/2005	McGee et al.
6,865,394	B2	3/2005	Ogino et al.	6,944,443	B2	9/2005	Bates et al.
6,865,395	B2	3/2005	Riley	6,944,447	B2	9/2005	Portman et al.
6,865,483	B1	3/2005	Cook, III et al.	6,944,540	B2	9/2005	King et al.
				6,944,704	B2	9/2005	Brelin
				6,947,772	B2	9/2005	Minear et al.
				6,947,880	B2	9/2005	Johnson et al.
				6,948,656	B2	9/2005	Williams

(56)

References Cited

U.S. PATENT DOCUMENTS

6,950,058	B1	9/2005	Davis et al.	7,016,717	B2	3/2006	Demos et al.
6,950,326	B2	9/2005	Suzuki	7,016,855	B2	3/2006	Eaton et al.
6,950,535	B2	9/2005	Sibayama et al.	7,020,494	B2	3/2006	Spriestersbach et al.
6,952,181	B2	10/2005	Karr et al.	7,020,701	B1	3/2006	Gelvin et al.
6,952,574	B2	10/2005	Taldi et al.	7,023,465	B2	4/2006	Stephens, Jr.
6,954,442	B2	10/2005	Tsirtsis et al.	7,023,980	B2	4/2006	Lenard
6,954,641	B2	10/2005	McKenna et al.	7,024,200	B2	4/2006	McKenna et al.
6,954,735	B1	10/2005	Djupsjobacka et al.	7,024,207	B2	4/2006	Gorday et al.
6,954,790	B2	10/2005	Forsl�w	7,024,214	B2	4/2006	Loveland
6,956,573	B1	10/2005	Bergen et al.	7,024,278	B2	4/2006	Chiappetta et al.
6,957,068	B2	10/2005	Hutchison, IV et al.	7,024,321	B1	4/2006	Deninger et al.
6,957,072	B2	10/2005	Kangras et al.	7,024,393	B1	4/2006	Peinado et al.
6,957,073	B2	10/2005	Bye	7,026,926	B1	4/2006	Walker, III
6,957,076	B2	10/2005	Hunzinger	7,026,928	B1	4/2006	Lane
6,957,393	B2	10/2005	Fano et al.	7,027,819	B2	4/2006	Ozturk et al.
6,961,019	B1	11/2005	McConnell et al.	7,031,725	B2	4/2006	Rorabaugh
6,961,312	B2	11/2005	Kubler et al.	7,031,728	B2	4/2006	Beyer, Jr.
6,961,562	B2	11/2005	Ross	7,031,875	B2	4/2006	Ellenby et al.
6,963,557	B2	11/2005	Knox	7,032,030	B1	4/2006	Codignotto
6,963,748	B2	11/2005	Chithambaram et al.	7,034,678	B2	4/2006	Burkley et al.
6,963,900	B2	11/2005	Boyd	7,034,681	B2	4/2006	Yamamoto et al.
6,965,754	B2	11/2005	King	7,035,618	B2	4/2006	Schnurr
6,965,767	B2	11/2005	Maggenti et al.	7,035,731	B2	4/2006	Smith
6,965,816	B2	11/2005	Walker	7,038,590	B2	5/2006	Hoffman et al.
6,965,868	B1	11/2005	Bednarek	7,039,596	B1	5/2006	Lu
6,968,044	B2	11/2005	Beason et al.	7,039,599	B2	5/2006	Merriman et al.
6,968,179	B1	11/2005	De Vries	7,039,603	B2	5/2006	Walker et al.
6,968,195	B2	11/2005	Nowak	7,042,338	B1	5/2006	Weber
6,970,130	B1	11/2005	Walters et al.	7,042,361	B2	5/2006	Kazdin et al.
6,970,837	B1	11/2005	Walker et al.	7,042,391	B2	5/2006	Meunier et al.
6,970,917	B1	11/2005	Kushwaha et al.	7,043,256	B2	5/2006	Ozgunur et al.
6,970,922	B1	11/2005	Spector	7,043,362	B2	5/2006	Krull et al.
6,973,320	B2	12/2005	Brown et al.	7,044,372	B2	5/2006	Okuda et al.
6,973,384	B2	12/2005	Zhao et al.	7,047,030	B2	5/2006	Forsyth
6,975,266	B2	12/2005	Abraham et al.	7,047,203	B2	5/2006	Johnson
6,975,873	B1	12/2005	Banks et al.	7,047,411	B1	5/2006	DeMello et al.
6,975,874	B1	12/2005	Bates et al.	7,047,549	B2	5/2006	Schein et al.
6,975,959	B2	12/2005	Dietrich et al.	7,050,624	B2	5/2006	Dialameh et al.
6,978,258	B2	12/2005	Chithambaram	7,050,655	B2	5/2006	Ho et al.
6,978,453	B2	12/2005	Rao et al.	7,050,797	B2	5/2006	Jung
6,980,813	B2	12/2005	Mohi et al.	7,050,818	B2	5/2006	Tendler
6,980,816	B2	12/2005	Rohles et al.	7,053,780	B1	5/2006	Straub et al.
6,980,909	B2	12/2005	Root et al.	7,053,822	B2	5/2006	Rickerson, Jr.
6,981,029	B1	12/2005	Menditto et al.	7,054,741	B2	5/2006	Harrison et al.
6,982,656	B1	1/2006	Coppinger et al.	7,057,556	B2	6/2006	Hall et al.
6,983,313	B1	1/2006	Korkea-Aho	7,057,591	B1	6/2006	Hautanen et al.
6,985,747	B2	1/2006	Chithambaram	7,058,208	B2	6/2006	Chang et al.
6,985,839	B1	1/2006	Motamedi et al.	7,058,594	B2	6/2006	Stewart
6,985,879	B2	1/2006	Walker et al.	7,062,269	B2	6/2006	Albertsson et al.
6,987,976	B2	1/2006	Kohar et al.	7,062,491	B2	6/2006	McNulty et al.
6,989,765	B2	1/2006	Gueziec	7,062,510	B1	6/2006	Eldering
6,990,462	B1	1/2006	Wilcox et al.	7,062,530	B2	6/2006	Scheinkman
6,990,472	B2	1/2006	Rosenhaft et al.	7,065,351	B2	6/2006	Carter et al.
6,990,495	B1	1/2006	Grason et al.	7,065,507	B2	6/2006	Mohammed et al.
6,993,327	B2	1/2006	Mathis	7,065,548	B2	6/2006	van Oldenborgh et al.
6,993,355	B1	1/2006	Pershan	7,069,023	B2	6/2006	Maanoja et al.
6,993,718	B2	1/2006	Fujihara	7,069,026	B2	6/2006	McClure
6,996,087	B2	2/2006	Ejzak	7,069,308	B2	6/2006	Abrams
6,996,251	B2	2/2006	Malone et al.	7,071,821	B2	7/2006	Adameczyk et al.
6,996,387	B2	2/2006	Chan	7,071,842	B1	7/2006	Brady, Jr.
6,996,720	B1	2/2006	DeMello et al.	7,072,454	B1	7/2006	Ward
6,999,779	B1	2/2006	Hashimoto	7,072,645	B2	7/2006	Schwinke et al.
6,999,782	B2	2/2006	Shaughnessy et al.	7,072,665	B1	7/2006	Blumberg et al.
6,999,783	B2	2/2006	Toyryla et al.	7,072,667	B2	7/2006	Olrik et al.
7,003,289	B1	2/2006	Kolls	7,072,672	B1	7/2006	Vanska et al.
7,003,604	B2	2/2006	Brelin	7,072,963	B2	7/2006	Anderson et al.
7,006,829	B2	2/2006	Zhao et al.	7,075,900	B2	7/2006	Peters
7,007,010	B2	2/2006	Cooper	7,076,255	B2	7/2006	Parupudi et al.
7,007,228	B1	2/2006	Carro	7,076,257	B2	7/2006	Kall
7,009,556	B2	3/2006	Stewart	7,076,737	B2	7/2006	Abbott et al.
7,010,144	B1	3/2006	Davis et al.	7,079,857	B2	7/2006	Maggenti et al.
7,012,901	B2	3/2006	Jagadeesan et al.	7,079,947	B2	7/2006	Runquist et al.
7,013,148	B1	3/2006	Ganesh	7,080,124	B1	7/2006	Shankar
7,013,216	B2	3/2006	Walters et al.	7,082,365	B2	7/2006	Sheha et al.
7,013,391	B2	3/2006	Herle et al.	7,084,758	B1	8/2006	Cole
				7,085,365	B2	8/2006	Kauppinen
				7,085,555	B2	8/2006	Zellner et al.
				7,085,637	B2	8/2006	Breed et al.
				7,085,678	B1	8/2006	Burrell et al.

(56)

References Cited

U.S. PATENT DOCUMENTS

7,085,818	B2	8/2006	Brown et al.	7,164,921	B2	1/2007	Owens et al.
7,089,110	B2	8/2006	Pechatnikov et al.	7,165,725	B2	1/2007	Casey
7,089,214	B2	8/2006	Wang	7,167,713	B2	1/2007	Anderson
7,089,264	B1	8/2006	Guido et al.	7,170,863	B1	1/2007	Denman et al.
7,091,851	B2	8/2006	Mason et al.	7,171,190	B2	1/2007	Ye et al.
7,091,852	B2	8/2006	Mason et al.	7,174,153	B2	2/2007	Ehlers
7,092,385	B2	8/2006	Gallant et al.	7,174,277	B2	2/2007	Vock et al.
7,092,573	B2	8/2006	Luo et al.	7,177,397	B2	2/2007	McCalmont et al.
7,092,702	B2	8/2006	Cronin et al.	7,177,398	B2	2/2007	Meer et al.
7,095,871	B2	8/2006	Jones et al.	7,177,399	B2	2/2007	Dawson et al.
7,096,029	B1	8/2006	Parupudi et al.	7,177,904	B1	2/2007	Mathur et al.
7,096,030	B2	8/2006	Huomo	7,181,189	B2	2/2007	Hotta et al.
7,096,233	B2	8/2006	Mori et al.	7,181,200	B2	2/2007	Malackowski et al.
7,099,770	B2	8/2006	Naden et al.	7,181,227	B2	2/2007	Wilson et al.
7,103,018	B1	9/2006	Hansen et al.	7,184,750	B2	2/2007	Tervo et al.
7,103,368	B2	9/2006	Teshima	7,184,790	B2	2/2007	Dorenbosch et al.
7,103,370	B1	9/2006	Creemer	7,185,352	B2	2/2007	Hallford et al.
7,103,470	B2	9/2006	Mintz	7,187,997	B2	3/2007	Johnson
7,103,471	B2	9/2006	Levi et al.	7,190,948	B2	3/2007	Donley et al.
7,103,574	B1	9/2006	Peinado et al.	7,190,960	B2	3/2007	Wilson et al.
7,103,806	B1	9/2006	Horvitz	7,194,273	B2	3/2007	Vaudreuil
7,106,717	B2	9/2006	Rousseau et al.	7,197,321	B2	3/2007	Erskine et al.
7,106,843	B1	9/2006	Gainsboro et al.	7,199,754	B2	4/2007	Krumm et al.
7,107,038	B2	9/2006	Fitch et al.	7,200,380	B2	4/2007	Havlark et al.
7,107,065	B2	9/2006	Overy et al.	7,200,394	B2	4/2007	Aoki et al.
7,107,228	B1	9/2006	Walker et al.	7,200,409	B1	4/2007	Ichikawa et al.
7,107,285	B2	9/2006	von Kaenel et al.	7,200,566	B1	4/2007	Moore et al.
7,110,749	B2	9/2006	Zellner et al.	7,202,776	B2	4/2007	Breed
7,110,753	B2	9/2006	Campen	7,202,814	B2	4/2007	Caspi et al.
7,110,773	B1	9/2006	Wallace et al.	7,203,502	B2	4/2007	Wilson et al.
7,110,880	B2	9/2006	Breed et al.	7,203,674	B2	4/2007	Cohen
7,113,797	B2	9/2006	Kelley et al.	7,203,752	B2	4/2007	Rice et al.
7,113,806	B2	9/2006	Gray	7,206,388	B2	4/2007	Diacakis
7,116,985	B2	10/2006	Wilson et al.	7,206,568	B2	4/2007	Sudit
7,117,015	B2	10/2006	Scheinert et al.	7,209,571	B2	4/2007	Davis et al.
7,117,088	B1	10/2006	Hanshew et al.	7,209,753	B2	4/2007	Raith
7,120,444	B2	10/2006	Silvester	7,209,755	B2	4/2007	Gorday et al.
7,120,459	B2	10/2006	Sawada et al.	7,209,758	B1	4/2007	Moll et al.
7,120,469	B1	10/2006	Urakawa	7,209,969	B2	4/2007	Lahti et al.
7,123,189	B2	10/2006	Lalik et al.	7,212,806	B2	5/2007	Karaoguz
7,123,693	B2	10/2006	Nelson et al.	7,213,048	B1	5/2007	Parupudi et al.
7,123,926	B2	10/2006	Himmelstein	7,215,967	B1	5/2007	Kransmo et al.
7,124,370	B2	10/2006	Fish	7,216,109	B1	5/2007	Donner
7,127,257	B2	10/2006	Riley et al.	7,218,242	B2	5/2007	Scalisi et al.
7,127,261	B2	10/2006	Van Erlach	7,218,940	B2	5/2007	Niemenmaa et al.
7,128,274	B2	10/2006	Kelley et al.	7,219,303	B2	5/2007	Fish
7,130,406	B2	10/2006	Pines et al.	7,221,937	B2	5/2007	Lau et al.
7,133,365	B2	11/2006	Klinker et al.	7,221,948	B2	5/2007	Tokkonen
7,133,909	B2	11/2006	Bahl	7,221,959	B2	5/2007	Lindqvist et al.
7,135,992	B2	11/2006	Karlsson et al.	7,222,018	B2	5/2007	Uyeki et al.
7,136,466	B1	11/2006	Gao	7,224,963	B2	5/2007	Anderson et al.
7,136,663	B2	11/2006	Metais et al.	7,224,966	B2	5/2007	Caspi et al.
7,136,838	B1	11/2006	Peinado et al.	7,224,978	B2	5/2007	Zellner et al.
7,139,252	B2	11/2006	Babu et al.	7,224,995	B2	5/2007	Rhoads
7,139,553	B2	11/2006	Alston	7,225,207	B1	5/2007	Ohazama et al.
7,139,664	B2	11/2006	Kelly et al.	7,228,136	B2	6/2007	Mylymaki et al.
7,142,900	B1	11/2006	Straub	7,231,218	B2	6/2007	Diacakis et al.
7,145,900	B2	12/2006	Nix et al.	7,231,219	B2	6/2007	Curtis et al.
7,146,129	B2	12/2006	Bostrom et al.	7,231,423	B1	6/2007	Horstmann et al.
7,149,503	B2	12/2006	Aarnio et al.	7,233,786	B1	6/2007	Harris et al.
7,149,533	B2	12/2006	Laird et al.	7,234,942	B2	6/2007	Hu et al.
7,149,625	B2	12/2006	Mathews et al.	7,236,742	B2	6/2007	Hall et al.
7,150,030	B1	12/2006	Eldering et al.	7,236,799	B2	6/2007	Wilson et al.
7,151,921	B2	12/2006	Otsuka	7,236,973	B2	6/2007	Kalthoff et al.
7,151,946	B2	12/2006	Maggenti et al.	7,237,019	B2	6/2007	Sogabe et al.
7,155,238	B2	12/2006	Katz	7,237,201	B2	6/2007	Fish
7,155,339	B2	12/2006	Tu	7,239,759	B2	7/2007	Nam et al.
7,155,521	B2	12/2006	Lahti et al.	7,239,943	B2	7/2007	Peltz
7,158,883	B2	1/2007	Fuchs et al.	7,240,036	B1	7/2007	Mamdani et al.
7,158,980	B2	1/2007	Shen	7,242,303	B2	7/2007	Patel et al.
7,162,221	B2	1/2007	Spitz et al.	7,242,950	B2	7/2007	Suryanarayana et al.
7,162,256	B2	1/2007	Seligmann et al.	7,243,355	B2	7/2007	Espino
7,162,454	B1	1/2007	Donner et al.	7,246,371	B2	7/2007	Diacakis et al.
7,164,117	B2	1/2007	Breed et al.	7,248,677	B2	7/2007	Randall et al.
7,164,883	B2	1/2007	Rappaport et al.	7,248,884	B2	7/2007	Miyamoto
				7,248,965	B2	7/2007	Tanizaki et al.
				7,251,312	B2	7/2007	D'Evelyn et al.
				7,251,561	B2	7/2007	Dotan et al.
				7,251,696	B1	7/2007	Horvitz

(56)

References Cited

U.S. PATENT DOCUMENTS

7,254,388	B2	8/2007	Nam et al.	7,340,240	B2	3/2008	McDonald
7,254,481	B2	8/2007	Yamada et al.	7,340,389	B2	3/2008	Vargas
7,256,711	B2	8/2007	Sheha et al.	7,340,691	B2	3/2008	Bassett et al.
7,256,737	B2	8/2007	Hall et al.	7,343,141	B2	3/2008	Ellis et al.
7,257,392	B2	8/2007	Tang et al.	7,343,165	B2	3/2008	Obradovich
7,257,416	B2	8/2007	Lee et al.	7,343,222	B2	3/2008	Solomon
7,260,186	B2	8/2007	Zhu et al.	7,343,317	B2	3/2008	Jokinen et al.
7,260,378	B2	8/2007	Holland et al.	7,343,408	B2	3/2008	Kushwaha et al.
7,260,384	B2	8/2007	Bales et al.	7,349,706	B2	3/2008	Kim et al.
7,263,437	B2	8/2007	Hirose et al.	7,350,236	B1	3/2008	Silverbrook et al.
7,266,376	B2	9/2007	Nakagawa	7,350,237	B2	3/2008	Vogel et al.
7,266,378	B2	9/2007	Norta et al.	7,353,016	B2	4/2008	Roundtree et al.
7,266,379	B2	9/2007	Blight et al.	7,353,034	B2	4/2008	Haney
7,266,836	B2	9/2007	Anttila et al.	7,353,139	B1	4/2008	Burrell et al.
7,269,425	B2	9/2007	Valko et al.	7,355,528	B2	4/2008	Yamane et al.
7,269,590	B2	9/2007	Hull et al.	7,359,706	B2	4/2008	Zhao
7,269,601	B2	9/2007	Kinno et al.	7,359,713	B1	4/2008	Tiwari
7,269,636	B2	9/2007	McCollum et al.	7,359,724	B2	4/2008	Torvinen
7,269,821	B2	9/2007	Sahinoja et al.	7,359,894	B1	4/2008	Liebman et al.
7,271,742	B2	9/2007	Sheha et al.	7,362,662	B2	4/2008	Lang
7,271,765	B2	9/2007	Stilp et al.	7,363,024	B2	4/2008	Jenkins
7,274,299	B2	9/2007	Osman	7,363,027	B2	4/2008	Hon et al.
7,274,332	B1	9/2007	Dupray	7,366,522	B2	4/2008	Thomas
7,274,939	B2	9/2007	Ruutu et al.	7,366,606	B2	4/2008	Uyeki
7,277,912	B2	10/2007	Corboy et al.	7,366,779	B1	4/2008	Crawford
7,277,923	B2	10/2007	Rensin et al.	7,369,508	B2	5/2008	Parantainen et al.
7,280,822	B2	10/2007	Fraccaroli	7,369,530	B2	5/2008	Keagy
7,280,975	B1	10/2007	Donner	7,370,283	B2	5/2008	Othmer
7,283,846	B2	10/2007	Spiestersbach et al.	7,373,820	B1	5/2008	James
7,284,033	B2	10/2007	Jhanji	7,376,591	B2	5/2008	Owens
7,284,064	B1	10/2007	Connelly	7,376,640	B1	5/2008	Anderson et al.
7,289,617	B2	10/2007	Barnes et al.	7,379,889	B2	5/2008	Ratzlaff et al.
7,289,813	B2	10/2007	Karaoguz	7,382,770	B2	6/2008	Bergman et al.
7,289,814	B2	10/2007	Amir et al.	7,382,773	B2	6/2008	Schoeneberger et al.
7,289,904	B2	10/2007	Uyeki	7,383,316	B2	6/2008	Koch et al.
7,292,142	B2	11/2007	Simon et al.	7,386,000	B2	6/2008	Lopponen et al.
7,292,685	B2	11/2007	Gray	7,386,392	B1	6/2008	Kabel et al.
7,292,935	B2	11/2007	Yoon	7,388,519	B1	6/2008	Kreft
7,295,556	B2	11/2007	Roese et al.	7,389,179	B2	6/2008	Jin et al.
7,298,327	B2	11/2007	Dupray et al.	7,389,275	B2	6/2008	Kemper et al.
7,299,008	B2	11/2007	Gluck	7,389,351	B2	6/2008	Horvitz
7,301,469	B1	11/2007	Hoffman et al.	7,394,896	B2	7/2008	Norton
7,301,536	B2	11/2007	Ellenby et al.	7,395,031	B1	7/2008	Ritter
7,302,254	B2	11/2007	Valloppillil	7,395,045	B2	7/2008	Jijina et al.
7,302,634	B2	11/2007	Lucovsky et al.	7,395,259	B2	7/2008	Bailey et al.
7,304,966	B2	12/2007	Phan-Anh et al.	7,397,379	B2	7/2008	Richards et al.
7,305,442	B1	12/2007	Lundy	7,398,151	B1	7/2008	Burrell et al.
7,307,636	B2	12/2007	Matraszek et al.	7,401,057	B2	7/2008	Eder
7,308,356	B2	12/2007	Melaku et al.	7,403,221	B2	7/2008	Yamazaki et al.
7,310,676	B2	12/2007	Bourne	7,403,786	B2	7/2008	Caspi et al.
7,315,746	B2	1/2008	Caspi et al.	7,403,908	B1	7/2008	Jaramillo
7,317,705	B2	1/2008	Hanson	7,403,942	B1	7/2008	Bayliss
7,318,041	B2	1/2008	Walker et al.	7,403,972	B1	7/2008	Lau et al.
7,319,931	B2	1/2008	Uyeki et al.	7,406,507	B2	7/2008	Piccioni
7,321,773	B2	1/2008	Hines et al.	7,409,384	B2	8/2008	Szeto et al.
7,324,987	B2	1/2008	Hsieh et al.	7,412,260	B2	8/2008	Gailey et al.
7,327,245	B2	2/2008	Krumm et al.	7,412,313	B2	8/2008	Isaac
7,327,312	B1	2/2008	Harris	7,413,513	B2	8/2008	Nguyen et al.
7,328,242	B1	2/2008	McCarthy et al.	7,414,637	B2	8/2008	Fogel et al.
7,328,455	B2	2/2008	Jutzi et al.	7,418,265	B2	8/2008	Hardy et al.
7,330,112	B1	2/2008	Emigh et al.	7,418,402	B2	8/2008	McCrossin et al.
7,330,895	B1	2/2008	Horvitz	7,421,154	B2	9/2008	Kinjo
7,330,899	B2	2/2008	Wong	7,421,422	B1	9/2008	Dempster et al.
7,333,480	B1	2/2008	Clarke et al.	7,421,486	B1	9/2008	Parupudi et al.
7,333,819	B2	2/2008	Caspi et al.	7,421,577	B2	9/2008	Ichikawa et al.
7,333,820	B2	2/2008	Sheha et al.	7,424,293	B2	9/2008	Zhu
7,333,956	B2	2/2008	Malcolm	7,424,363	B2	9/2008	Cheng et al.
7,334,728	B2	2/2008	Williams	7,426,380	B2	9/2008	Hines et al.
7,336,819	B2	2/2008	Gallagher et al.	7,426,403	B2	9/2008	Sundararajan et al.
7,336,928	B2	2/2008	Paalasmaa et al.	7,428,417	B2	9/2008	Caspi et al.
7,336,949	B2	2/2008	Nasielski	7,428,571	B2	9/2008	Ichimura
7,337,061	B2	2/2008	Naden et al.	7,433,694	B2	10/2008	Morgan et al.
7,337,210	B2	2/2008	Barsness	7,436,785	B1	10/2008	McMullen et al.
7,337,465	B2	2/2008	Kiyoto et al.	7,437,413	B2	10/2008	Okuyama et al.
7,339,496	B2	3/2008	Endo et al.	7,437,444	B2	10/2008	Houri
				7,439,847	B2	10/2008	Pederson
				7,440,442	B2	10/2008	Grabelsky et al.
				7,440,573	B2	10/2008	Lor et al.
				7,440,842	B1	10/2008	Vorona

(56)

References Cited

U.S. PATENT DOCUMENTS

7,441,203	B2	10/2008	Othmer et al.	7,570,668	B2	8/2009	Mettala et al.
7,441,706	B1	10/2008	Schuessler et al.	7,573,825	B2	8/2009	Iffland
7,447,508	B1	11/2008	Tendler	7,573,982	B2	8/2009	Breen et al.
7,450,934	B2	11/2008	Caspi et al.	7,574,222	B2	8/2009	Sawada et al.
7,453,219	B2	11/2008	Mor et al.	7,577,131	B2	8/2009	Joseph et al.
7,455,586	B2	11/2008	Nguyen et al.	7,577,448	B2	8/2009	Pande et al.
7,457,628	B2	11/2008	Blumberg et al.	7,577,747	B2	8/2009	Banet et al.
7,457,634	B2	11/2008	Morinaga et al.	7,580,384	B2	8/2009	Kubler et al.
7,458,080	B2	11/2008	Parker et al.	7,584,114	B2	9/2009	Estrada et al.
7,460,863	B2	12/2008	Steelberg et al.	7,586,861	B2	9/2009	Kubler et al.
7,461,528	B2	12/2008	Taniguchi et al.	7,587,345	B2	9/2009	Mann et al.
7,463,972	B2	12/2008	Yamada et al.	7,590,589	B2	9/2009	Hoffberg
7,464,050	B1	12/2008	Deaton et al.	7,593,605	B2	9/2009	King et al.
7,469,298	B2	12/2008	Kitada et al.	7,593,718	B2	9/2009	Gorday et al.
7,472,172	B2	12/2008	Anderson et al.	7,596,625	B2	9/2009	Manion et al.
7,472,202	B2	12/2008	Parupudi et al.	7,599,580	B2	10/2009	King et al.
7,472,338	B2	12/2008	Carro	7,599,790	B2	10/2009	Rasmussen et al.
7,472,396	B2	12/2008	Jacobs et al.	7,599,983	B2	10/2009	Harper et al.
7,474,741	B2	1/2009	Brunson et al.	7,603,112	B2	10/2009	Huomo et al.
7,474,896	B2	1/2009	Mohi et al.	7,603,229	B2	10/2009	Goldberg et al.
7,475,057	B1	1/2009	Obradovich	7,606,416	B2	10/2009	Han et al.
7,475,059	B2	1/2009	Irlle et al.	7,606,577	B2	10/2009	Caspi et al.
7,477,694	B2	1/2009	Sanderford, Jr. et al.	7,606,663	B2	10/2009	Neef et al.
7,477,873	B2	1/2009	Tanaka et al.	7,606,687	B2	10/2009	Galbreath et al.
7,477,906	B2	1/2009	Radic et al.	7,606,741	B2	10/2009	King et al.
7,478,078	B2	1/2009	Lunt et al.	7,610,145	B2	10/2009	Kantarjiev et al.
7,479,983	B2	1/2009	Fisher et al.	7,613,634	B2	11/2009	Siegel et al.
7,480,566	B2	1/2009	Laverty	7,613,812	B2	11/2009	Manion et al.
7,480,567	B2	1/2009	Suomela et al.	7,617,128	B2	11/2009	Greak
7,483,944	B2	1/2009	Parupudi et al.	7,617,176	B2	11/2009	Zeng et al.
7,483,946	B2	1/2009	Boyd	7,620,404	B2	11/2009	Chesnais et al.
7,484,176	B2	1/2009	Blattner et al.	7,620,621	B2	11/2009	Fuselier et al.
7,486,958	B2	2/2009	Sheha et al.	7,623,848	B2	11/2009	Rosenfelt et al.
7,487,148	B2	2/2009	James	7,623,860	B2	11/2009	Hurst
7,489,938	B2	2/2009	Flynn et al.	7,623,871	B2	11/2009	Sheynblat
7,490,056	B2	2/2009	Nash	7,623,966	B2	11/2009	Butler, Jr.
7,490,144	B2	2/2009	Carlson et al.	7,627,425	B2	12/2009	Salmre et al.
7,493,363	B2	2/2009	Huitema et al.	7,627,498	B1	12/2009	Walker et al.
7,496,082	B2	2/2009	Lee	7,630,986	B1	12/2009	Herz et al.
7,496,347	B2	2/2009	Puranik	7,636,755	B2	12/2009	Blattner et al.
7,496,633	B2	2/2009	Szeto et al.	7,640,009	B2	12/2009	Belkin et al.
7,496,648	B2	2/2009	Manion et al.	7,640,300	B2	12/2009	Wohlgemuth et al.
7,502,610	B2	3/2009	Maher	7,643,834	B2	1/2010	Ioppe et al.
7,509,422	B2	3/2009	Jaffray et al.	7,644,144	B1	1/2010	Horvitz et al.
7,512,544	B2	3/2009	Carter et al.	7,644,166	B2	1/2010	Appelman et al.
7,519,372	B2	4/2009	MacDonald et al.	7,649,872	B2	1/2010	Naghian et al.
7,519,548	B2	4/2009	Hanechak et al.	7,650,142	B2	1/2010	Longman et al.
7,519,703	B1	4/2009	Stuart et al.	7,653,574	B2	1/2010	Harper et al.
7,522,627	B2	4/2009	Lam et al.	7,657,079	B2	2/2010	Lake et al.
7,522,995	B2	4/2009	Nortrup	7,663,502	B2	2/2010	Breed
7,523,191	B1	4/2009	Thomas et al.	7,664,233	B1	2/2010	Kirchmeier et al.
7,525,484	B2	4/2009	Dupray et al.	7,664,509	B2	2/2010	Zellner et al.
7,525,955	B2	4/2009	Velez-Rivera et al.	7,668,649	B2	2/2010	Onishi
7,526,306	B2	4/2009	Brems et al.	7,668,832	B2	2/2010	Yeh et al.
7,529,556	B2	5/2009	Dunko et al.	7,668,864	B2	2/2010	Benson et al.
7,529,557	B2	5/2009	Farrill	7,670,263	B2	3/2010	Ellis et al.
7,529,617	B2	5/2009	Ono et al.	7,672,439	B2	3/2010	Appelman et al.
7,529,723	B2	5/2009	Howard et al.	7,672,639	B2	3/2010	Vaddiparty et al.
7,532,809	B2	5/2009	Boston et al.	7,675,889	B2	3/2010	Nakao et al.
7,532,878	B2	5/2009	Hagebarth	7,680,340	B2	3/2010	Luo et al.
7,532,899	B2	5/2009	Wilson et al.	7,680,796	B2	3/2010	Yeh et al.
7,536,256	B2	5/2009	Kelley et al.	7,680,942	B2	3/2010	Tu et al.
7,536,437	B2	5/2009	Zmolek	7,685,279	B2	3/2010	Miltonberger et al.
7,538,745	B2	5/2009	Borovoy et al.	7,688,211	B2	3/2010	Borovoy et al.
7,545,784	B2	6/2009	Mgrdechian et al.	7,688,260	B2	3/2010	Pomerantz et al.
7,545,916	B2	6/2009	Schwartz	7,688,811	B2	3/2010	Kubler et al.
7,546,127	B2	6/2009	Caspi et al.	7,693,752	B2	4/2010	Jaramillo
7,551,733	B2	6/2009	Denny et al.	7,693,944	B2	4/2010	Appelman et al.
7,558,584	B2	7/2009	Yamamoto et al.	7,696,905	B2	4/2010	Ellenby et al.
7,558,696	B2	7/2009	Vilppula et al.	7,698,228	B2	4/2010	Gailey et al.
7,564,348	B2	7/2009	Staton et al.	7,702,728	B2	4/2010	Zaner et al.
7,565,153	B2	7/2009	Alcock et al.	7,702,739	B1	4/2010	Cheng et al.
7,565,155	B2	7/2009	Sheha et al.	7,706,516	B2	4/2010	Seligmann
7,568,025	B2	7/2009	Vasudeva	7,706,970	B2	4/2010	Inoue
7,568,203	B2	7/2009	Dotan et al.	7,706,977	B2	4/2010	Soehren
				7,707,109	B2	4/2010	Odiijk et al.
				7,707,122	B2	4/2010	Hull et al.
				7,707,262	B1	4/2010	Bill
				7,711,604	B1	5/2010	Walker et al.

(56)

References Cited

U.S. PATENT DOCUMENTS

7,714,712 B2	5/2010	Emigh et al.	7,917,157 B2	3/2011	Muhonen
7,714,778 B2	5/2010	Dupray	7,917,414 B2	3/2011	Nathanson
7,716,287 B2	5/2010	Appelman et al.	7,920,871 B2	4/2011	Okuda
7,716,585 B2	5/2010	Glass	7,930,342 B2	4/2011	Mattila et al.
7,717,866 B2	5/2010	Damen	7,937,066 B2	5/2011	Kaltsukis
7,721,084 B2	5/2010	Salminen et al.	7,940,746 B2	5/2011	Livingood
7,724,743 B2	5/2010	Razdan et al.	7,941,161 B2	5/2011	Ioppe et al.
7,728,724 B1	6/2010	Scalisi et al.	7,941,162 B2	5/2011	Ioppe et al.
7,729,691 B2	6/2010	Newville	7,944,909 B2	5/2011	James
7,730,012 B2	6/2010	Arrouye et al.	7,945,276 B2	5/2011	Pedersen
7,730,014 B2	6/2010	Hartenstein et al.	7,945,494 B2	5/2011	Williams
7,730,063 B2	6/2010	Eder	7,958,457 B1	6/2011	Brandenberg et al.
7,730,389 B2	6/2010	Rasmussen et al.	7,967,678 B2	6/2011	Dougherty et al.
7,738,896 B2	6/2010	Patel et al.	7,969,306 B2	6/2011	Ebert et al.
7,743,074 B1	6/2010	Parupudi et al.	7,970,749 B2	6/2011	Uhlir et al.
7,747,258 B2	6/2010	Farmer	7,974,388 B2	7/2011	Sadot
7,747,719 B1	6/2010	Horvitz et al.	7,974,868 B2	7/2011	Tseng et al.
7,756,253 B2	7/2010	Breen et al.	7,983,226 B2	7/2011	Oommen et al.
7,756,537 B2	7/2010	Laurila et al.	8,010,100 B2	8/2011	Kushwaha et al.
7,756,639 B2	7/2010	Colley et al.	RE42,738 E	9/2011	Williams
7,761,309 B2	7/2010	Sacco et al.	8,019,355 B2	9/2011	Shim
7,764,231 B1	7/2010	Karr et al.	8,019,630 B2	9/2011	Dale
7,764,944 B2	7/2010	Rollender	8,023,958 B2	9/2011	Wang et al.
7,764,950 B2	7/2010	Patel et al.	8,027,333 B2	9/2011	Grabelsky et al.
7,764,961 B2	7/2010	Zhu et al.	8,032,149 B2	10/2011	Kennedy et al.
7,765,206 B2	7/2010	Hillis et al.	RE42,927 E	11/2011	Want et al.
7,769,975 B2	8/2010	Ripberger	8,073,895 B2	12/2011	Hamzeh et al.
7,774,158 B2	8/2010	Domingues Goncalves et al.	8,078,189 B2	12/2011	Chang et al.
7,774,453 B2	8/2010	Babu et al.	8,126,889 B2	2/2012	Pitt
7,783,297 B2	8/2010	Ishii	8,140,658 B1	3/2012	Gelvin et al.
7,784,684 B2	8/2010	Labrou et al.	8,150,617 B2	4/2012	Manber et al.
7,787,896 B2	8/2010	Kundu et al.	2001/0011247 A1	8/2001	O'Flaherty et al.
7,788,260 B2	8/2010	Lunt et al.	2001/0029465 A1	10/2001	Strisower
7,792,273 B2	9/2010	Fano et al.	2001/0033286 A1	10/2001	Stokes et al.
7,793,316 B2	9/2010	Mears et al.	2001/0040886 A1	11/2001	Jimenez et al.
7,797,204 B2	9/2010	Balent	2001/0041021 A1	11/2001	Boyle et al.
7,797,367 B1	9/2010	Gelvin et al.	2001/0048364 A1	12/2001	Kalthoff et al.
7,802,724 B1	9/2010	Nohr	2001/0049274 A1	12/2001	Degraeve
RE41,899 E	10/2010	Rose et al.	2001/0049671 A1	12/2001	Joerg
7,812,766 B2	10/2010	Leblanc et al.	2001/0055976 A1	12/2001	Crouch et al.
7,813,722 B2	10/2010	Patel et al.	2002/0000930 A1	1/2002	Crowson et al.
7,813,741 B2	10/2010	Hendrey et al.	2002/0002504 A1	1/2002	Engel et al.
7,813,873 B2	10/2010	Smartt et al.	2002/0002899 A1	1/2002	Gjerdengen et al.
7,814,502 B2	10/2010	Blomqvist et al.	2002/0016197 A1	2/2002	Candelaria
7,818,317 B1	10/2010	Emigh et al.	2002/0019829 A1	2/2002	Shapiro
7,822,425 B2	10/2010	Shim et al.	2002/0022993 A1	2/2002	Miller et al.
7,822,426 B1	10/2010	Wuersch	2002/0026289 A1	2/2002	Kuzunuki et al.
7,827,176 B2	11/2010	Korte et al.	2002/0030665 A1	3/2002	Ano
7,827,279 B2	11/2010	Xu et al.	2002/0035493 A1	3/2002	Mozayeny et al.
7,828,655 B2	11/2010	Uhlir et al.	2002/0035609 A1	3/2002	Lessard et al.
7,831,668 B2	11/2010	Deeds	2002/0036122 A1	3/2002	Fayette et al.
7,840,224 B2	11/2010	Vengroff et al.	2002/0037735 A1	3/2002	Maggenti et al.
7,840,681 B2	11/2010	Acharya et al.	2002/0042266 A1	4/2002	Heyward et al.
7,840,699 B2	11/2010	Fujita et al.	2002/0046069 A1	4/2002	Mozayeny et al.
7,844,132 B2	11/2010	Boese et al.	2002/0046077 A1	4/2002	Mozayeny et al.
7,844,254 B2	11/2010	Arnold et al.	2002/0046084 A1	4/2002	Steele et al.
7,844,687 B1	11/2010	Gelvin et al.	2002/0046232 A1	4/2002	Adams et al.
7,848,760 B2	12/2010	Caspi et al.	2002/0052214 A1	5/2002	Maggenti et al.
7,848,761 B2	12/2010	Caspi et al.	2002/0052786 A1	5/2002	Kim et al.
7,848,948 B2	12/2010	Perkowski et al.	2002/0054174 A1	5/2002	Abbott et al.
7,853,268 B2	12/2010	Karaoguz et al.	2002/0055373 A1	5/2002	King et al.
7,853,272 B2	12/2010	Tipnis et al.	2002/0055924 A1	5/2002	Liming
7,856,311 B2	12/2010	Matsuura et al.	2002/0061760 A1	5/2002	Maggenti et al.
7,860,519 B2	12/2010	Portman et al.	2002/0077119 A1	6/2002	Fitch et al.
7,869,816 B2	1/2011	Merheb et al.	2002/0077144 A1	6/2002	Keller et al.
7,870,240 B1	1/2011	Horvitz	2002/0077897 A1	6/2002	Zellner et al.
7,873,639 B2	1/2011	Shipman	2002/0091991 A1	7/2002	Castro
7,877,275 B2	1/2011	Ball	2002/0094787 A1	7/2002	Avnet et al.
7,885,898 B2	2/2011	Narayanaswami et al.	2002/0098832 A1	7/2002	Fleischer et al.
7,899,473 B2	3/2011	Pohutsky et al.	2002/0099769 A1	7/2002	Yasui et al.
7,899,682 B2	3/2011	Sacco et al.	2002/0111154 A1	8/2002	Eldering et al.
7,900,039 B2	3/2011	Shim et al.	2002/0111172 A1	8/2002	DeWolf et al.
7,904,244 B2	3/2011	Sugla	2002/0112047 A1	8/2002	Kushwaha et al.
7,904,511 B2	3/2011	Ryan et al.	2002/0112237 A1	8/2002	Kelts
7,917,153 B2	3/2011	Orwant et al.	2002/0115453 A1	8/2002	Poulin et al.
			2002/0116336 A1	8/2002	Diacakis et al.
			2002/0123327 A1	9/2002	Vataja
			2002/0126146 A1	9/2002	Burns et al.
			2002/0126656 A1	9/2002	Park

(56)

References Cited

U.S. PATENT DOCUMENTS

2002/0127530	A1	9/2002	Weakly	2004/0036649	A1	2/2004	Taylor
2002/0128773	A1	9/2002	Chowanic et al.	2004/0044574	A1	3/2004	Cochran et al.
2002/0140560	A1	10/2002	Altman et al.	2004/0044623	A1	3/2004	Wake et al.
2002/0154213	A1	10/2002	Sibyama et al.	2004/0044674	A1	3/2004	Mohammadioun et al.
2002/0160815	A1	10/2002	Patel et al.	2004/0068439	A1	4/2004	Elgrably
2002/0161633	A1	10/2002	Jacob et al.	2004/0068724	A1	4/2004	Gardner, III et al.
2002/0164993	A1	11/2002	Elliot	2004/0072583	A1	4/2004	Weng
2002/0165771	A1	11/2002	Walker et al.	2004/0073361	A1	4/2004	Tzamaloukas et al.
2002/0165773	A1	11/2002	Natsuno et al.	2004/0083050	A1	4/2004	Biyani
2002/0167442	A1	11/2002	Taylor	2004/0102201	A1	5/2004	Levin
2002/0169539	A1*	11/2002	Menard et al. 701/200	2004/0103182	A1	5/2004	Krabel et al.
2002/0173905	A1	11/2002	Jin et al.	2004/0139049	A1	7/2004	Hancock et al.
2002/0178088	A1	11/2002	Lurie et al.	2004/0158584	A1	8/2004	Necsoiu et al.
2002/0183059	A1	12/2002	Noreen et al.	2004/0176907	A1	9/2004	Nesbitt
2002/0183072	A1	12/2002	Steinbach et al.	2004/0181807	A1	9/2004	Theiste et al.
2002/0186164	A1	12/2002	Hsu et al.	2004/0186854	A1	9/2004	Choi
2002/0191595	A1	12/2002	Mar et al.	2004/0192349	A1	9/2004	Reilly
2003/0003933	A1	1/2003	Deshpande et al.	2004/0192351	A1	9/2004	Duncan
2003/0013449	A1	1/2003	Hose et al.	2004/0198332	A1	10/2004	Lundsgaard
2003/0023586	A1	1/2003	Knorr	2004/0198379	A1	10/2004	Magee et al.
2003/0032404	A1	2/2003	Wager et al.	2004/0198386	A1	10/2004	Dupray
2003/0033582	A1	2/2003	Klein et al.	2004/0198397	A1	10/2004	Weiss
2003/0035567	A1	2/2003	Chang et al.	2004/0203630	A1	10/2004	Wang
2003/0040272	A1	2/2003	Lelievre et al.	2004/0203746	A1	10/2004	Knauerhase et al.
2003/0055560	A1	3/2003	Phillips	2004/0203845	A1	10/2004	Lal
2003/0055983	A1	3/2003	Callegari	2004/0203847	A1	10/2004	Knauerhase et al.
2003/0056218	A1	3/2003	Wingard et al.	2004/0203854	A1	10/2004	Nowak
2003/0060213	A1	3/2003	Heinonen et al.	2004/0203890	A1	10/2004	Karaoguz et al.
2003/0060215	A1	3/2003	Graham	2004/0203909	A1	10/2004	Koster
2003/0060976	A1	3/2003	Sato et al.	2004/0203923	A1	10/2004	Mullen
2003/0061206	A1	3/2003	Qian	2004/0205151	A1	10/2004	Sprigg et al.
2003/0061211	A1	3/2003	Shultz et al.	2004/0215516	A1	10/2004	Denoon et al.
2003/0064705	A1	4/2003	Desiderio	2004/0235493	A1	11/2004	Ekerborn
2003/0065788	A1	4/2003	Salomaki	2004/0236504	A1	11/2004	Bickford et al.
2003/0065934	A1	4/2003	Angelo et al.	2004/0242149	A1	12/2004	Luneau
2003/0069683	A1	4/2003	Lapidot et al.	2004/0243307	A1	12/2004	Geelen
2003/0074136	A1	4/2003	Hancock et al.	2004/0248586	A1	12/2004	Patel et al.
2003/0078064	A1	4/2003	Chan	2004/0250212	A1	12/2004	Fish
2003/0078886	A1	4/2003	Minear et al.	2004/0259641	A1	12/2004	Ho
2003/0087647	A1	5/2003	Hurst	2004/0267445	A1	12/2004	De Luca et al.
2003/0096621	A1	5/2003	Jana et al.	2005/0002419	A1	1/2005	Doviak et al.
2003/0096628	A1	5/2003	Bar-On et al.	2005/0015197	A1	1/2005	Ohtsuji et al.
2003/0097468	A1	5/2003	Hamadi	2005/0027666	A1	2/2005	Beck, Jr. et al.
2003/0100316	A1	5/2003	Odamura	2005/0028034	A1	2/2005	Gantman et al.
2003/0100320	A1	5/2003	Ranjan	2005/0032527	A1	2/2005	Sheha et al.
2003/0100326	A1*	5/2003	Grube et al. 455/515	2005/0038696	A1	2/2005	Kalevik et al.
2003/0100334	A1	5/2003	Mazzara, Jr.	2005/0039140	A1	2/2005	Chen
2003/0101225	A1	5/2003	Han et al.	2005/0039178	A1	2/2005	Marolia et al.
2003/0101341	A1	5/2003	Kettler, III et al.	2005/0041578	A1	2/2005	Huotari et al.
2003/0101450	A1	5/2003	Davidsson et al.	2005/0043036	A1	2/2005	Ioppe et al.
2003/0104782	A1	6/2003	Wong et al.	2005/0049789	A1	3/2005	Kelly et al.
2003/0109245	A1	6/2003	McCalmont et al.	2005/0054352	A1	3/2005	Karaizman
2003/0119528	A1	6/2003	Pew et al.	2005/0054361	A1	3/2005	Turcanu et al.
2003/0126150	A1	7/2003	Chan	2005/0055374	A1	3/2005	Sato
2003/0134648	A1	7/2003	Reed	2005/0060162	A1	3/2005	Mohit et al.
2003/0148774	A1	8/2003	Naghian et al.	2005/0063563	A1	3/2005	Soliman
2003/0149527	A1	8/2003	Sikila	2005/0065959	A1	3/2005	Smith et al.
2003/0153340	A1	8/2003	Crockett et al.	2005/0071702	A1	3/2005	Morisawa
2003/0153341	A1	8/2003	Crockett et al.	2005/0086261	A1	4/2005	Mammone
2003/0153343	A1	8/2003	Crockett et al.	2005/0086467	A1	4/2005	Asokan et al.
2003/0163287	A1	8/2003	Vock et al.	2005/0096042	A1	5/2005	Habeman et al.
2003/0177058	A1	9/2003	Needham	2005/0096840	A1	5/2005	Simske
2003/0191682	A1	10/2003	Shepard et al.	2005/0096978	A1	5/2005	Black
2003/0196105	A1	10/2003	Fineberg	2005/0101314	A1	5/2005	Levi
2003/0200128	A1	10/2003	Doherty	2005/0104976	A1	5/2005	Currans
2003/0200192	A1	10/2003	Bell et al.	2005/0108643	A1	5/2005	Schybergson et al.
2003/0216960	A1	11/2003	Postrel	2005/0112030	A1	5/2005	Gaus
2003/0217150	A1	11/2003	Roese et al.	2005/0114527	A1	5/2005	Hankey et al.
2003/0218539	A1	11/2003	Hight	2005/0116027	A1	6/2005	Algiene et al.
2003/0220835	A1	11/2003	Barnes, Jr.	2005/0125343	A1	6/2005	Mendelovich
2003/0223381	A1	12/2003	Schroderus	2005/0134504	A1	6/2005	Harwood et al.
2004/0002359	A1	1/2004	Deas et al.	2005/0134578	A1	6/2005	Chambers et al.
2004/0010358	A1	1/2004	Oesterling et al.	2005/0143094	A1	6/2005	Reed et al.
2004/0010489	A1	1/2004	Rio	2005/0144333	A1	6/2005	Kotzin
2004/0021567	A1	2/2004	Dunn	2005/0149443	A1	7/2005	Torvinen
				2005/0153724	A1	7/2005	Vij et al.
				2005/0169248	A1	8/2005	Truesdale et al.
				2005/0176411	A1	8/2005	Taya et al.
				2005/0185060	A1	8/2005	Neven et al.

(56)

References Cited

U.S. PATENT DOCUMENTS

2005/0186954	A1	8/2005	Kenney
2005/0192999	A1	9/2005	Cook et al.
2005/0198305	A1	9/2005	Pezaris et al.
2005/0202830	A1	9/2005	Sudit
2005/0202831	A1	9/2005	Sudit
2005/0202832	A1	9/2005	Sudit
2005/0202834	A1	9/2005	Sudit
2005/0203698	A1	9/2005	Lee
2005/0209815	A1	9/2005	Russon et al.
2005/0209995	A1	9/2005	Aksu et al.
2005/0210104	A1	9/2005	Torvinen
2005/0216457	A1	9/2005	Walther et al.
2005/0221843	A1	10/2005	Friedman et al.
2005/0222756	A1	10/2005	Davis et al.
2005/0222905	A1	10/2005	Wills
2005/0222961	A1	10/2005	Staib et al.
2005/0227705	A1	10/2005	Rousu et al.
2005/0228719	A1	10/2005	Roberts et al.
2005/0228860	A1	10/2005	Hamynen et al.
2005/0232252	A1	10/2005	Hoover
2005/0233776	A1	10/2005	Allen et al.
2005/0234891	A1	10/2005	Walther et al.
2005/0245232	A1	11/2005	Jakober et al.
2005/0250440	A1	11/2005	Zhou et al.
2005/0250516	A1	11/2005	Shim
2005/0255857	A1	11/2005	Kim et al.
2005/0256866	A1	11/2005	Lu
2005/0256867	A1	11/2005	Walther et al.
2005/0259675	A1	11/2005	Tuohino et al.
2005/0261829	A1	11/2005	Furukawa
2005/0262081	A1	11/2005	Newman
2005/0265318	A1	12/2005	Khartabil et al.
2005/0282518	A1	12/2005	D'Evelyn et al.
2005/0286421	A1	12/2005	Janacek
2005/0288036	A1	12/2005	Brewer et al.
2005/0289097	A1	12/2005	Trossen et al.
2006/0003804	A1	1/2006	Liu
2006/0004834	A1	1/2006	Pyhalammi et al.
2006/0021009	A1	1/2006	Lunt
2006/0023747	A1	2/2006	Koren et al.
2006/0025071	A1	2/2006	Yamazaki et al.
2006/0030339	A1	2/2006	Zhovnirovsky et al.
2006/0030347	A1	2/2006	Biswaas
2006/0035647	A1	2/2006	Eisner et al.
2006/0036680	A1	2/2006	Shim
2006/0040676	A1	2/2006	Chen
2006/0040710	A1	2/2006	Ruetschi et al.
2006/0046761	A1	3/2006	Bishop et al.
2006/0047419	A1	3/2006	Diendorf et al.
2006/0047825	A1	3/2006	Steenstra et al.
2006/0053048	A1	3/2006	Tandetnik
2006/0053225	A1	3/2006	Poikselka et al.
2006/0058042	A1	3/2006	Shim
2006/0058955	A1	3/2006	Mehren
2006/0061488	A1	3/2006	Dunton
2006/0064346	A1	3/2006	Steenstra et al.
2006/0068753	A1	3/2006	Karpen et al.
2006/0079249	A1	4/2006	Shim
2006/0080286	A1	4/2006	Svendsen
2006/0085392	A1	4/2006	Wang et al.
2006/0085477	A1	4/2006	Phillips et al.
2006/0094353	A1	5/2006	Nielsen et al.
2006/0111944	A1	5/2006	Sirmans, Jr. et al.
2006/0128411	A1	6/2006	Turcanu
2006/0129451	A1	6/2006	Kohanim et al.
2006/0148490	A1	7/2006	Bates et al.
2006/0149606	A1	7/2006	Goan, Jr. et al.
2006/0150119	A1	7/2006	Chesnais et al.
2006/0166679	A1*	7/2006	Karaoguz et al. 455/456.1
2006/0170956	A1	8/2006	Jung et al.
2006/0174203	A1	8/2006	Jung et al.
2006/0179160	A1	8/2006	Uehara et al.
2006/0187227	A1	8/2006	Jung et al.
2006/0187228	A1	8/2006	Jung et al.
2006/0187230	A1	8/2006	Jung et al.

2006/0189337	A1	8/2006	Farrill et al.
2006/0190812	A1	8/2006	Ellenby et al.
2006/0211453	A1	9/2006	Schick
2006/0212558	A1	9/2006	Sahinoja et al.
2006/0212562	A1	9/2006	Kushwaha et al.
2006/0217127	A1	9/2006	Drane et al.
2006/0218175	A1	9/2006	Stuhec
2006/0218181	A1	9/2006	Jeon
2006/0221197	A1	10/2006	Jung et al.
2006/0224662	A1	10/2006	Richardson et al.
2007/0019614	A1	1/2007	Hoffmann
2007/0022011	A1	1/2007	Altberg et al.
2007/0041513	A1	2/2007	Gende
2007/0049288	A1	3/2007	Lamprecht et al.
2007/0121601	A1	5/2007	Kikinis et al.
2007/0202844	A1	8/2007	Wilson et al.
2007/0263560	A1	11/2007	Saarisalo et al.
2007/0276591	A1	11/2007	Lea et al.
2008/0046516	A1	2/2008	Hyoung et al.
2008/0086240	A1	4/2008	Breed
2008/0129528	A1	6/2008	Guthrie
2008/0287116	A1	11/2008	Drane et al.
2009/0019532	A1	1/2009	Jacobsen et al.
2009/0030605	A1	1/2009	Breed
2009/0047973	A1	2/2009	MacNaughtan et al.
2009/0197612	A1	8/2009	Kiiskinen
2009/0215465	A1	8/2009	MacNaughtan et al.
2010/0125498	A1	5/2010	Jaramillo
2011/0205054	A1	8/2011	Ioppe et al.
2011/0207479	A1	8/2011	Ioppe et al.

FOREIGN PATENT DOCUMENTS

AU	2003903789	8/2003
AU	2004905077	9/2004
AU	2005901352	3/2005
AU	2005901353	3/2005
BR	9904979 A	12/2000
CA	2163215	11/1994
CA	2189515 A1	7/1997
CA	2287596 A1	4/2000
CA	2432239 A1	12/2004
DE	3621456 A1	1/1988
DE	4437360 A1	4/1996
DE	19506890 A1	8/1996
DE	19914257 A1	1/2000
DE	10141695 A1	3/2003
EP	288068 B1	7/1992
EP	0745867 A1	12/1996
EP	0763749 A1	3/1997
EP	0785535 A1	7/1997
EP	0786646 A2	7/1997
EP	0809117 A2	11/1997
EP	0813072 B1	12/1997
EP	699330 B1	4/1998
EP	0908835 A2	4/1999
EP	0997808 A2	5/2000
EP	1083764 B1	3/2001
EP	1300652 A2	4/2003
EP	1457928 A1	9/2004
EP	1465041 A2	10/2004
EP	1469287 A2	10/2004
EP	1496338 A2	1/2005
EP	1659817 A2	5/2006
FR	2730083 A1	8/1996
FR	2754093 A1	4/1998
FR	2810183 A1	12/2001
GB	2278196 A	11/1994
GB	2322248 A	8/1998
GB	2359888 A	9/2001
GB	0324800.2	10/2003
GB	2407230 A	4/2005
JP	62142215 A	6/1987
JP	05-071974	3/1993
JP	08-005394	1/1996
JP	08-069436	3/1996
JP	08-069436 A	3/1996
JP	08-510578	11/1996
JP	09-054895	2/1997

(56)

References Cited

FOREIGN PATENT DOCUMENTS

JP	09-054895	A	2/1997
JP	09-062993	A	3/1997
JP	04-354149		12/2004
JP	2005-006081		1/2005
JP	2006-260338		9/2006
KR	10-2004-0036490		5/2004
KR	2004-102440	A	12/2004
KR	10-2005-14287		2/2005
KR	2005-096746	A	10/2005
KR	10-2004-112991		7/2006
KR	10-2004-115411		7/2006
KR	2005-1675		7/2006
KR	10-2004-0064538		9/2006
KR	10-2005-0024544		9/2006
TW	2004-26387		12/2004
TW	2006-27985	A	6/2006
TW	93135920		6/2006
TW	94102945		6/2006
TW	93141508		7/2006
WO	9320546	A1	10/1993
WO	94/08250		4/1994
WO	97/07467		2/1997
WO	9707467	A1	2/1997
WO	98054682	A1	12/1998
WO	9916036	A1	4/1999
WO	01/31966	A1	5/2001
WO	01/37597	A1	5/2001
WO	0208863	A2	1/2002
WO	02/054813	A1	7/2002
WO	03005747	A1	1/2003
WO	03009605	A2	1/2003
WO	03/023593	A1	3/2003
WO	93/20546		3/2003
WO	03/096055	A2	11/2003
WO	2004/008792	A1	1/2004
WO	2004/021730	A1	3/2004
WO	2004/061576	A2	7/2004
WO	2004073217	A1	8/2004
WO	2004/076977	A1	9/2004
WO	2004093348	A1	10/2004
WO	2005/006258	A1	1/2005
WO	2005038400	A1	4/2005
WO	2005052802	A1	6/2005
WO	2005/084052	A1	9/2005
WO	2006001412	A1	1/2006
WO	2006010977	A1	2/2006
WO	2006014439	A2	2/2006
WO	2006054340	A1	5/2006
WO	2006/065856	A1	6/2006
WO	2006108071	A2	10/2006
WO	2006108071	A3	10/2006
WO	2008065245		6/2008

OTHER PUBLICATIONS

U.S. Appl. No. 60/576,092, filed Jun. 2, 2004. First named inventor: Krishnakant Patel. Entitled, "Pre-Provisioning for P2T Over the Air Activation."

U.S. Appl. No. 60/576,094, filed Jun. 2, 2004. First named inventor: F. Craig Farrill. Entitled, "Technique for Zero Delay Call Set-Up in Press to Talk (P2T) Systems."

U.S. Appl. No. 60/577,971, filed Jun. 8, 2004. First named inventor: Dan Illowsky. Entitled, "Architecture, Apparatus and Methods Thereof for an Efficient Low Cost Seamless Device Interoperability Software Platform."

U.S. Appl. No. 60/579,309, filed Jun. 14, 2004. First named inventor: Ravi Ayyasamy. Entitled, "Client Specification and Architecture for Supporting Press to Talk and Other Premium Voice Services in Wireless Networks."

U.S. Appl. No. 60/579,322, filed Jun. 15, 2004. First named inventor: Ahmad, Ahmad M. Entitled, "Method and system for Modeling People Traveling Behavior."

U.S. Appl. No. 60/581,466, filed Jun. 21, 2004. First named inventor: Arianna Bassoli. Entitled, "Synchronized media streaming between distributed peers."

U.S. Appl. No. 60/581,954, filed Jun. 22, 2004. First named inventor: F. Craig Farrill. Entitled, "Press-to-Connect (PTC) for Wireless Communications Systems."

U.S. Appl. No. 60/582,280, filed Jun. 22, 2004. First named inventor: Tony F. Rodriguez. Entitled, "Digital asset management and targeted searching using digital watermarks."

U.S. Appl. No. 60/582,313, filed Jun. 23, 2004. First named inventor: Julian Bourne. Entitled, "Method and System for Identifying, Locating and Contacting Like-Minded People."

U.S. Appl. No. 60/588,464, filed Jul. 16, 2004. First named inventor: Deepankar Biswaas; and Title: "Virtual Push to Talk (PTT) and Push to Share (PTS)".

U.S. Appl. No. 60/590,152, filed Jul. 21, 2004. First named inventor: Brian Roundtree. Entitled, "Mobile Device Assistance, Mobile Device Management, and Call Interceptor for Mobile Devices."

U.S. Appl. No. 60/592,838, filed Jul. 30, 2004. First named inventor: David S. Breed. Entitled, "System for obtaining vehicular information."

U.S. Appl. No. 60/595,805, filed Aug. 4, 2004. First named inventor: Igor Zhovnirovsky. Entitled, "System for Implementing Serverless Applications Over the Public Wireless Network."

U.S. Appl. No. 60/602,642, filed Aug. 19, 2004. First named inventor: Harper; Gregory W. Entitled, "Digital Music Download."

U.S. Appl. No. 60/605,345, filed Aug. 27, 2004. First named inventor: Scott Shamp. Entitled, "Wireless communication of context sensitive content, systems methods and computer program product."

U.S. Appl. No. 60/605,498, filed Aug. 31, 2004. First named inventor: William Meadow. Entitled, "Video and data processing system."

U.S. Appl. No. 60/606,590, filed Sep. 2, 2004. First named inventor: Diendorf; John R.; et al. Entitled, "Telematic method and apparatus for managing shipping logistics."

U.S. Appl. No. 60/609,948, filed Sep. 15, 2004. First named inventor: Phil Stanhope. Entitled, "System and method for synchronizing data."

U.S. Appl. No. 60/609,989, filed Sep. 15, 2004. First named inventor: John Landry. Entitled, "System and method for sharing content."

U.S. Appl. No. 60/609,990, filed Sep. 15, 2004. First named inventor: John Landry. Entitled, "System and method for linking data."

U.S. Appl. No. 60/610,016, filed Sep. 15, 2004. First named inventor: Phil Stanhope. Entitled, "System and method for sharing content."

U.S. Appl. No. 60/610,079, filed Sep. 15, 2004. First named inventor: Phil Stanhope. Entitled, "System and method for auditing data."

U.S. Appl. No. 60/611,607, filed Sep. 21, 2004. First named inventor: Brian Roundtree. Entitled, "Secure Mobile Device Software Execution, Help-Support-Care Initiation for Mobile Devices, and Smart Network Configuration Selection for Mobile Devices."

U.S. Appl. No. 60/613,646, filed Sep. 27, 2004. First named inventor: Morris Lee. Entitled, "Methods and apparatus for using location information to manage spillover in an audience monitoring system."

U.S. Appl. No. 60/614,939, filed Sep. 29, 2004. First named inventor: Morris Lee. Entitled, "Methods and apparatus for using location information to manage spillover in an audience monitoring system."

U.S. Appl. No. 60/618,201, filed Oct. 12, 2004. First named inventor: Wendy Wan-Lin Yang. Entitled, "Systems and methods for managing and presenting entity information."

U.S. Appl. No. 60/618,748, filed Oct. 15, 2004. First named inventor: Blumberg; et al. Entitled, "Mobile location aware search engine and method of providing content for same."

U.S. Appl. No. 60/620,456, filed Oct. 19, 2004. First named inventor: Rosen; James S. Entitled, "System and method for location based social networking."

U.S. Appl. No. 60/622,797, filed Oct. 29, 2004. First named inventor: Bill. Entitled, "Dynamically Predicting an Event at a Location."

U.S. Appl. No. 60/623,108, filed Oct. 29, 2004. First named inventor: Edward James Morgan. Entitled, "Wireless data Scanning Network for Building Location Beacon Database."

U.S. Appl. No. 60/624,281, filed Jan. 29, 2005. First named inventor: Ching-Fang Lin. Entitled, "Interruption free navigator."

(56)

References Cited

OTHER PUBLICATIONS

- U.S. Appl. No. 60/625,467, filed Nov. 5, 2004. First named inventor: Houston Staton. Entitled, "Method and System for Remote Monitoring and Control of Movable Entities."
- U.S. Appl. No. 60/626,573, filed Nov. 10, 2004. First named inventor: Chung, Wing Yeung ; et al. Entitled, "Locomotive wireless video recorder and recording system."
- U.S. Appl. No. 60/626,977, filed Nov. 12, 2004. First named inventor: Lyn Seidler. Entitled, "System and method for automated friend-to-friend delivery item."
- U.S. Appl. No. 60/627,785, filed Nov. 12, 2004. First named inventor: Gagan Puranik. Entitled, "Two-way messaging with encryption."
- U.S. Appl. No. 60/629,721, filed Nov. 19, 2004. First named inventor: Wong; Raymond et al. Entitled, "Bid Write-Up."
- U.S. Appl. No. 60/631,602, filed Nov. 30, 2004. First named inventor: Jeffrey Lynn Meckley. Entitled, "Phase persistent agile signal source."
- U.S. Appl. No. 60/631,876, filed Dec. 1, 2004. First named inventor: Barry Appelman. Entitled, "Automatically Enabling the Forwarding of Instant Messages."
- U.S. Appl. No. 60/634,951, filed Dec. 10, 2004. First named inventor: Andre Gueziec. Entitled, "Real-time and predictive traveler information for routing."
- U.S. Appl. No. 60/635,856, filed Dec. 13, 2004. First named inventor: Dan Burkhardt. Entitled, "Instant Messaging Method and Apparatus."
- U.S. Appl. No. 60/636,953, filed Dec. 17, 2004. First named inventor: Coch; et al. Entitled, "Geo-Collaboration System."
- U.S. Appl. No. 60/639,267, filed Dec. 27, 2004. First named inventor: Andrew Levi. Entitled, "Method and system for peer-to-peer advertising between mobile devices."
- U.S. Appl. No. 60/643,721, filed Jan. 13, 2005. First named inventor: Baowei Ji. Entitled, "Medium access control (MAC) protocol for use in ad hoc wireless networks."
- U.S. Appl. No. 60/647,897, filed Jan. 13, 2005. First named inventor: Baowei Ji. Entitled, "Asynchronous wireless collision detection with acknowledgment for use in ad hoc wireless networks."
- U.S. Appl. No. 60/649,180, filed Feb. 3, 2005. First named inventor: Cyril Hourii. Entitled, "System and Method for Geographically Locating Computing Devices in a Wireless Network."
- U.S. Appl. No. 60/650,840, filed Feb. 7, 2005. First named inventor: Jens Eilstrup Rasmussen. Entitled, "Method and Apparatus for Generating Tiles in a Digital Mapping System."
- U.S. Appl. No. 60/652,144, filed Feb. 11, 2005. First named inventor: Brian Roundtree. Entitled, "Call Intercept Methods, Such as for Customer Self-Support on a Mobile Device."
- U.S. Appl. No. 60/654,271, filed Feb. 18, 2005. First named inventor: Krishnakant Patel. Entitled, "Enhanced Features on an Advanced Voice Services (AVS) Framework."
- U.S. Appl. No. 60/654,811, filed Feb. 22, 2005. First named inventor: Edward James Morgan. Entitled, "Continuous Data Optimization in Positioning System."
- Lamarca, Anthony et al. "Place Lab: Device Positioning Using Radio Beacons in the Wild." 2005. 18 pages.
- Mulligan, Morris et al. "Framework for Location Computation Scenarios." Internet-Draft. Nov. 2001. pp. 1-11.
- Priyantha, Nissanka B. "The Cricket Location-Support System." MIT Laboratory for Computer Science. The 6th ACM International Conference on Mobile Computing and Networking (ACM MOBICOM). Aug. 2000. 12 pages.
- Reed, Jeffrey H. et al. "An Overview of the Challenges and Progress in Meeting the E-911 Requirement for Location Service." IEEE Communications Magazine. Apr. 1998. pp. 30-37.
- Sen, Sumit. "Open Standards in Location Based Services." Applied Technology Group, Tata Infotech Limited. 2002. 6 pages.
- Abowd et al., "Cyberguide: A mobile context-aware tour guide." Baltzer Journals. Sep. 23, 1996. pp. 1-21.
- Kim H. Veltman "Frontiers in Electronic Media", Interactions Journal of the ACM, New York, Jul.-Aug. 1997, pp. 32-64.
- Henning Maass "Location-aware mobile applications based on directory services." Mobile Networks and Applications 3 (1998) 157-173.
- Sinclair "Integrating Hypermedia Techniques with Augmented Reality Environments" University of Southampton. Jun. 2004. pp. 1-155.
- Eija Kaasinen "User needs for location-aware mobile services." Springer-Verlag London Limited. Aug. 2002. pp. 70-79.
- Broadbent et al. "Location Aware Mobile Interactive Guides: usability issues." Proceedings of the Fourth International Conference on Hypermedia and Interactivity in Museums. (ICHIM97) (Paris, 1997). pp. 1-15.
- "DaimlerCrysler Guide5 Usecases Overview Map." Oct. 2001. 1 page.
- "GPS 12 Personal Navigator™ Owner's Manual & Reference." Garmin Corporation. 1999. 66 pages.
- "Travel Time Data Collection Handbook—Chapter 5: ITS Probe Vehicle Techniques." FHWA-PL98-035 Report, Department of Transport, University of Texas. Mar. 1998. 70 pages.
- Hoogenraad "Location Dependent Services." 3rd AGILE Conference on Geographic Information Science, Helsinki/Espoo, Finland, May 2000. pp. 74-77.
- Balsiger et al., "MOGID: Mobile Geo-depended Information on Demand." Workshop on Position Dependent Information Services (W3C-WAP), 2000, 8 pages.
- Efstratiou et al. "Reflection: A Solution for Highly Adaptive Mobile Systems," 2000 Workshop on Reflective Middleware, 2000, 2 pages.
- Popescu-Zeletin et al., "Applying Location-Aware Computing for Electronic Commerce: Mobile Guide" Proc. 5th Conference on Computer Communications, AFRICOM-CCDC'98, Oct. 20-22, 1998, 14 pages.
- Zhao, "Mobile Phone Location Determination and Its Impact on Intelligent Transportation Systems," IEEE Transactions on Intelligent Transportation Systems, Mar. 2000, 1(1):55-64.
- Popescu-Zeletin et al., "Applying Location-Aware Computing for Electronic Commerce: Mobile Guide," Proc. 5th Conference on Computer Communications, AFRICOM-CCDC'98, Oct. 20-22, 1998, 14 pages.
- Yokote, "The Apertos Reflective Operating System: The Concept and Its Implementation," SCSL TR 92 014, Jun. 26, 1992, 23 pages.
- Long et al., "Rapid Prototyping of Mobile Context-Aware Applications: The Cyberguide Case Study," MobiCom '96, 1996, 11 pages.
- Leonhardt et al., "Towards a general location service for mobile environments," Proc. Third International Workshop on Services in Distributed and Networked Environments, Jun. 3-4, 1996, 8 pages.
- Leonhardt et al., "Multi-Sensor Location Tracking," MOBICOM 98, Dallas, TX, 12 pages.
- Kreller et al., "UMTS: A Middleware Architecture and Mobile API Approach," IAPRS, vol. XXXIII, Amsterdam, 2000, 7 pages.
- Klinec and Volz, "Nexus-Positioning and Communication Environment for Spatially Aware Applications," IAPRS, vol. XXXIII, Amsterdam, 2000, 7 pages.
- "Digital cellular telecommunications system (Phase 2+); Specification of the SIM Application Toolkit for the Subscriber Identity Module—Mobile Equipment (SIM-ME) interface (GSM 11.14)" Global System for Mobile Communications, Dec. 1996, 56 pages.
- "Estonian operator to launch world's first Network-based location services," Ericsson Press Release, Oct. 11, 1999, 1 page.
- Efstratiou et al., "Architectural Requirements for the Effective Support of Adaptive Mobile Applications," 2000, 12 pages.
- Drane et al., "Positioning GSM Telephones," IEEE Communications Magazine, Apr. 1998, pp. 46-59.
- Dix et al., "Exploiting Space and Location as a Design Framework for Interactive Mobile Systems," ACM Transactions on Computer-Human Interaction (TOCHI)—Special issue on human-computer interaction with mobile systems, 2000, 36 pages.
- Davies et al., "'Caches in the Air': Disseminating Tourist Information in the Guide System," Second IEEE Workshop on Mobile Computer Systems and Applications, Feb. 25-26, 1999, 9 pages.
- Davies et al., "L2imbo: A distributed systems platform for mobile computing," Mobile Networks and Applications, 1998, 21 pages.
- Cheverst et al., "Supporting Collaboration in Mobile-aware Groupware," Workshop on Handheld CSCW, 1998, 6 pages.
- Cheverst et al., "Sharing (Location) Context to Facilitate Collaboration Between City Visitors," 2000, 5 pages.

(56)

References Cited

OTHER PUBLICATIONS

- Cheverst et al., "Services to Support Consistency in Mobile Collaborative Applications," Proc. 3rd International Workshop on Services in Distributed Networked Environments, 1996, 8 pages.
- Cheverst et al., "Experiences of Developing and Deploying a Context-Aware Tourist Guide: The Guide Project," 2000, 12 pages.
- Cheverst et al., "Developing Interfaces for Collaborative Mobile Systems," 1999, 15 pages.
- Cheverst et al., "Design of an Object Model for a Context Sensitive Tourist Guide," 1999, 4 pages.
- Efstratiou et al., "Reflection: A Solution for Highly Adaptive Mobile Systems," 2000 Workshop on Reflective Middleware, 2000, 2 pages.
- Cheverst et al., "The Role of Connectivity in Supporting Context-Sensitive Applications," HUC'99, LNCS 1707, 1999, 15 pages.
- Cheverst et al., "Architectural Ideas for the Support of Adaptive Context-Aware Applications," Proceedings of Workshop on Infrastructure for Smart Devices—How to Make Ubiquity an Actuality, HUC'00, Bristol, Sep. 2000, 3 pages.
- Balsiger et al., "MOGID: Mobile Geo-depended Information on Demand," [online] Retrieved from the Internet on May 25, 2012: URL: <http://www.w3.org/Mobile/posdep/wap-v2.htm>, Workshop on Position Dependent Information Services (W3C-WAP), 2000, 9 pages.
- Borsodi, "Super Resolution of Discrete Arrivals in a Cellular Geolocation System," University of Calgary Thesis, Apr. 2000, 164 pages.
- Akerblom, "Tracking Mobile Phones in Urban Areas," Goteborg University Thesis, Sep. 2000, 67 pages.
- Digital cellular telecommunications system (Phase 2+); Location Services (LCS); Service description, Stage 1 (GSM 02.71) ETSI, Apr. 1999, 22 pages.
- "3rd Generation Partnership Project (3GPP); Technical Specification Group (TSG) RAN; Working Group 2 (WG2); Report on Location Services," TS RAN R2.03 V0.1.0, Apr. 21-23, 1999, 43 pages.
- "Enabling UMTS / Third Generation Services and Applications," No. 11 Report from the UMTS Forum, Oct. 2000, 72 pages.
- "3rd Generation Partnership Project; Technical Specification Group Radio Access Network; Stage 2 Functional Specification of Location Services in UTRAN," 3G TS 25.305 v.3.1.0, Mar. 2000, 47 pages.
- "3rd Generation Partnership Project; Technical Specification Group Services and System Aspects; Functional stage 2 description of location services in UMTS," 3G TS 23.171 v.3.1.0, 1999, 55 pages.
- "Report on Location Service feature (LCS) 25.923 v1.0.0," TSG-RAN Working Group 2 (Radio layer 2 and Radio layer 3), Berlin, May 25-28, 1999, 45 pages.
- Wang et al., "Location Aware Information Agent over WAP," Tamkang Journal of Science and Engineering, 2000, 3(2):107-115.
- Tarumi et al., "Public Applications of SpaceTag and Their Impacts," Digital Cities, LNCS 1765, 2000, 14 pages.
- O'Grady et al., "A Tourist-Centric Mechanism for Interacting with the Environment," Proceedings of the First International Workshop on Managing Interactions in Smart Environments (MANSE '99), Dublin, Ireland, Dec. 1999, 12 pages.
- McCarthy et al., "ACTIVEMAP: A Visualization Tool for Location Awareness to Support Informal Interactions," HUC '99, LNCS 1707, 1999, 13 pages.
- Hodes et al., "Composable Ad hoc Location-based Services for Heterogeneous Mobile Clients," University of California, Berkeley, May 5, 1998, 16 pages.
- Dey et al., "CyberDesk: a framework for providing self-integrating context-aware services," ACM, Inc, 1998, 8 pages.
- Brown, "Triggering Information by Context," [online] Retrieved from the Internet on May 25, 2012: URL: <http://kar.kent.ac.uk/21602/2/pdf.pdf>, The University of Kent at Canterbury, 1998, 10 pages.
- Brown, "The stick-e document: a framework for creating context-aware applications," Electronic Publishing, 1995, 8:259-272.
- Clarke et al., "Development of Human Factors Guidelines for Advanced Traveler Information Systems (ATIS) and Commercial Vehicle Operations (CVO): Comparable Systems Analysis," U.S. Department of Transportation Federal Highway Administration, Publication No. FHWA-RD-95-197, Dec. 1996, 212 pages.
- "LaBarge in joint venture on bus system," [online] Retrieved from the Internet on May 25, 2012: URL: <http://www.bizjournals.com/stlouis/stories/1998/08/10/focus2.html>, Aug. 9, 1998, 1 page.
- Shekhar et al., "Genesis and Advanced Traveler Information Systems (ATIS): Killer Applications for Mobile Computing?" NSF Mobidata Workshop on Mobile and Wireless Information Systems, Nov. 1994, 20 pages.
- Serafin et al., "Functions and Features of Future Driver Information Systems," Technical Report UMTRI-91-16, May 1991, 104 pages.
- Ni et al., "On-Board Advanced Traveler Information Systems," Earlier Faculty Research, University of California Transportation Center, UC Berkeley, Dec. 1, 2002, 11 pages.
- "School Buses to Carry Noticom's First Application," [online] Retrieved from the Internet on May 25, 2012: URL: http://findarticles.com/p/articles/mi_m0BMD/is_1999_Feb_17/ai_n27547754/?tag=content;coll, Communications Today, Feb. 17, 1999, 2 pages.
- Mahmassani et al., "Providing Advanced and Real-Time Travel/Traffic Information to Tourists," Center for Transportation Research, Bureau of Engineering Research, The University of Texas at Austin, Oct. 1998, 15 pages.
- Yim et al., "Travinfo Field Operational Test: Work Plan for the Target, Network, and Value Added Reseller (VAR) Customer Studies," Working Papers, California Partners for Advanced Transit and Highways (PATH), Institute of Transportation Studies, UC Berkeley, Apr. 1, 1997, 48 pages.
- Khattak et al., "Bay Area ATIS Testbed Plan," Research Reports, California Partners for Advanced Transit and Highways (PATH), Institute of Transportation Studies, UC Berkeley, Aug. 1992, 83 pages.
- Burnett, "Usable Vehicle Navigation Systems: Are We There Yet?" Vehicle Electronic Systems 2000, Jun. 29-30, 2000, pp. 3.1.1-3.1.12.
- Noonan et al., "Advanced Traveler Information Systems," Intelligent Transportation Systems Field Operational Test Cross-Cutting Study, Sep. 1998, 27 pages.
- Bonsignore, "A Comparative Evaluation of the Benefits of Advanced Traveler Information System (ATIS) Operational Tests," MIT Masters Thesis, Feb. 1994, 140 pages.
- Hoogenraad, "Location Dependent Services," 3rd AGILE Conference on Geographic Information Science, Helsinki/Espoo, Finland, May 25-27, 2000, pp. 74-77.
- Miller et al., "Integrating Hierarchical Navigation and Querying: A User Customizable Solution," ACM Multimedia Workshop on Effective Abstractions in Multimedia Layout, Presentation, and Interaction, San Francisco, CA, Nov. 1995, 8 pages.
- Wheeler et al., "Development of Human Factors Guidelines for Advanced Traveler Information Systems and Commercial Vehicle Operations: Task Analysis of ATIS/CVO Functions," US Dept. Transportation Federal Highway Administration Research and Development, Publication No. FHWA-RD-95-176, Nov. 1996, 124 pages.
- Benefon ESCI GSM+GPS Personal Navigation Phone, benefon.com, Copyright 2001, 4 pages.
- Dey, "Context-Aware Computing: The CyberDesk Project," [online] Retrieved from the Internet on May 25, 2012: URL: <http://www.cc.gatech.edu/fce/cyberdesk/pubs/AAAI98/AAAI98.html>; AAAI '98 Spring Symposium, Stanford University, Mar. 23-25, 1998, 8 pages.
- Ygnace et al., "Travel Time Estimation on the San Francisco Bay Area Network Using Cellular Phones as Probes", Working Paper, Institute of Transportation Studies, University of California, Berkeley, 2000, 56 pages.
- Civilis et al., "Efficient Tracking of Moving Objects with Precision Guarantees", A DB Technical Report TR-5, Feb. 21, 2004, 23 pages.
- Clarke et al., "An Architecture for Dynamically Extensible Operating Systems," Distributed Multimedia Research Group, Department of Computing, Lancaster University, 1998, 20 pages.
- Veltman, "Frontiers in Electronic Media", Interactions Journal of the ACM, New York, Jul.-Aug. 1997, pp. 32-64.
- Goran M. Djuknie, Robert E. Richton, "Geolocation and Assisted GPS," Computer, vol. 34, No. 2, pp. 123-125, Feb. 2001.

(56)

References Cited

OTHER PUBLICATIONS

- Rozier et al., "Hear & There: An Augmented Reality System of Linked Audio", Proceedings of the International Conference on Auditory Display, Atlanta, GA, Apr. 2000, 6 pages.
- Rekimoto et al., "Augment-able Reality: Situated Communication through Physical and Digital Spaces", *iswc*, Second International Symposium on Wearable computers (ISWC'98), 1998, 8 pages.
- Nardi et al., "Integrating Communication and Information through Contact Map", *Communications of the ACM*, vol. 45, No. 4, Apr. 2002, 9 pages.
- Meier et al., "Location-Aware Event-Base Middleware: A Paradigm for Collaborative Mobile Applications?", Department of Computer Science, Trinity College Dublin, Ireland, Sep. 2003, 5 pages.
- "Map Reading and Land Navigation Field Manual No. 3-25.26", Headquarters Department of the Army, Washington, DC, [online] Retrieved from the Internet on May 25, 2012: URL: <http://155.217.58.58/cgi-bin/atdl.dll/fm/3-25.26/toc.htm>, Jul. 20, 2001, pp. 1-7 and J-1 to J-3.
- Dibdin, "Where are mobile location based services?", CM316 Multimedia Systems Paper, Dec. 14, 2001, 8 pages.
- Charny, "AT&T puts 411 to the text", [online] Retrieved from the Internet on May 25, 2012: URL: http://news.cnet.com/2100-1039_3-1000669.html; May 8, 2003; 5 pages.
- Bederson, "Audio Augmented Reality: A Prototype Automated Tour Guide", [online] Retrieved from the Internet on May 25, 2012: URL: <http://www.cs.umd.edu/~bederson/papers/chi-95-aar/>, ACM Human Computer in Computing Systems conference (CHI'95) 1995, 4 pages.
- Feddema; et al., "Cooperative Sentry Vehicles and Differential GPS Leapfrog," 2000, United States Department of Energy, pp. 1-12.
- Maxwell; et al., "Alfred: The Robot Waiter Who Remembers You," AAAI Technical Report WS-99-15, 1999, 12 pages.
- Shibata; et al., "Development and Integration of Generic Components for a Teachable Vision-Based Mobile Robot," *IEEE/ASME Transactions on Mechatronics*, 1996, 1(3):230-236.
- "27 Countries in your pocket"; [online] [Retrieved on Sep. 29, 2005] Retrieved from the Internet URL: <http://www.mio-tech.be/en/printview/press-releases-2005-09-29.htm>; 1 page.
- "Mio 269+ Users Manula"; 2005; 44 pages.
- Balliet, "Transportation Information Distribution System", IBM Technical Disclosure Bulletin, [online] [Retrieved Nov. 7, 2008] Retrieved from the Internet, URL: <https://www.delphion.com/tbds/tdb?order=86A+61395>; Jun. 1986; 2 pages.
- Beard; et al., "Estimating Positions and Paths of Moving Objects", *IEEE* 2000, pp. 1-8.
- Berman; et al., "The Role of Dead Reckoning and Inertial Sensors in Future General Aviation Navigation", *IEEE*, 1998, pp. 510-517.
- Boonsrimuang; et al., "Mobile Internet Navigation System", *IEEE*, 2002, pp. 325-328.
- Camp; et al., "A computer-based method for predicting transit time systems", *Decision Sciences*, vol. 5, pp. 339-346, 1974.
- Christie; et al., "Development and Deployment of GPS wireless devices for E911 and Location based services", *IEEE* 2002.
- Dunn; et al., "Wireless Emergency Call System", IBM TDB, Sep. 1994.
- Ebine, "Dual Frequency resonant base station antennas for PDC systems in Japan", *IEEE*, pp. 564-567, 1999.
- Evans, "In-Vehicle Man-Machine Interaction the Socrates Approach", *Vehicle Navigation & Information System Conference Proceedings*, Aug. 31-Sep. 2, 1994, pp. 473-477.
- Helal; et al., "Drishti: An Integrated Navigation System for Visually Impaired and Disabled", *Fifth International Symposium on Wearable Computers (ISWC'01)*, *IEEE*, 2001, pp. 149-156.
- Hohman; et al., "GPS Roadside Integrated Precision Positioning System", *Position Location and Navigation Symposium (IEEE 2000)*, pp. 221-230.
- Jain, R., "Potential Networking Applications of Global Positioning Systems (GPS)", [online] [retrieved on Nov. 18, 2008] [retrieved from <http://arxiv.org/ftp/cs/papers/9809/9809079.pdf>] OSU Technical Report TR-24, Apr. 1996, pp. 1-40.
- Jirawimut; et al., "A Method for Dead Reckoning Parameter Correction in Pedestrian Navigation System", *IEEE Transactions on Instrumentation and Measurement*, vol. 52, No. 1, Feb. 2003, pp. 209-215.
- Lloyd; et al., "Cellular phone base stations installation violate the Electromagnetic Compatibility regulations", *IEEE*, 2004.
- Miller; et al., "Synchronization of Mobile XML Databases by Utilizing Deferred Views", *IEEE* 2004.
- Nardi; et al., "Integrating Communication and Information through Contact Map", *Communications of the ACM*, vol. 45, No. 4, Apr. 2002.
- Northard, "Docking Station Communication Link", IBM TDB, Feb. 1994.
- Oh; et al., "Spatial Applications Using 4S Technology for Mobile Environment", *IEEE* 2002.
- Paksoy; et al., "The Global Position System—Navigation Tool of the Future", *Journal of Electrical & Electronics*, 2002, vol. 2, No. 1, pp. 467-476.
- Parikh, "Tele Locate", IBM Technical Disclosure Bulletin, [online] [Retrieved Nov. 7, 2008] Retrieved from the Internet, URL: <https://www.delphion.com/tbds/tdb?order=92A+62775>; Sep. 1992; 1 page.
- RD 409052, Research Disclosure Alerting Abstract, "Location dependent information for satellite based vehicle communication-required application of Global Position System (GPS) to automatically extract relevant portions of data package as vehicle changes position," May 10, 1998, 1 page.
- Rogers; et al., "Adaptive User Interfaces for Automotive Environments", *IEEE Intelligent Vehicles Symposium 2000*, Oct. 3-5, 2000, pp. 662-667.
- Samadani; et al., "PathMaker: Systems for Capturing Trips", *IEEE (2004) International Conference on Multimedia and Expo., Publication Date: Jun. 27-30, 2004*, vol. 3, pp. 2123-2126, 2004.
- Spoehrer, "New Paradigms for Using Computers", 1997; retrieved from the Internet, URL: <http://almaden.ibm.com/npsc97/1997/spoehrer.htm>.
- Yang; et al. "Global Snapshots for Distributed Debugging", *IEEE*, pp. 436-440, 1992.
- Yanyan; et al., "The model of optimum route selection in vehicle automatic navigation system based on unblocked reliability analyses", *IEEE* 2003.
- Civilis; et al., "Efficient Tracking of Moving Objects with Precision Guarantees", *IEEE, Proceedings of the First Annual International Conference on Mobile and Ubiquitous Systems: Networking and Services*, 2004, 10 pages.
- Budka; et al., "A Bayesian method to Improve Mobile Geolocation Accuracy", *IEEE*, 2002, pp. 1021-1025.
- Yamamoto; et al., "Position Location Technologies Using Signal Strength in Cellular Systems", *IEEE*, 2001, pp. 2570-2575.
- Drane; et al., "The accurate location of mobile telephones", *Third Annual World Congress on Intelligent Transport Systems*, Orlando, Florida, Oct. 1996.
- Wang; et al., "A Unified Vehicle Supervising and Traffic Information System", *IEEE*, 1996, pp. 968-972.
- US 6,731,928, May 4, 2004, Tanaka (withdrawn).
- Challe, "CARMINAT—An Integrated information and guidance system," *Vehicle Navigation and Information Systems Conference*, Oct. 20-23, 1991, Renault—Direction de la Recherche, Rueil-Malmaison, France.
- Pungel, "Traffic control—beat the jam electronically," *Funkschau*, 1988, 18;43-45.
- Rillings and Betsold, "Advanced driver information systems," *IEEE Vehicular Technology Society*, 1991, 40:31-40.
- Tsuzawa and Okamoto, "Advanced Mobile Traffic Information and Communication System," *First Vehicle Navigation and Information Systems Conference*, Sep. 11-13, 1989, Toronto, Canada, Abstract only.
- Wong, "GPS: making roads safer and solving traffic tangles," *Asia Engineer*, 1995, 23(9):31-32.
- Ayatsuka; et al., "UbiquitousLinks: Hypermedia Links Embedded in the Real World, Technical Report of Information Processing Society, 96-HI-67," *Information Processing Society of Japan*, Jul. 11, 1996, 96(62):23-30.

(56)

References Cited

OTHER PUBLICATIONS

Nagao; et al., *Walk Navi: A Location-Aware Interactive Navigation/ Guideline System and Software III*, First edition, pp. 9-48, published by Kindai-Kagaku-Sya Co. Ltd., Dec. 10, 1995.

Freundschuh, "Does 'Anybody' Really Want (Or Need) Vehicle Navigation Aids?" First Vehicle Navigation and Information System Conference, Sep. 11-13, 1989, Toronto, Canada, 5 pages.

Gould, "The Provision of Usable Navigation Assistance: Considering Individual Cognitive Ability," First Vehicle Navigation and Information System Conference, Sep. 11-13, 1989, Toronto, Canada, 7 pages.

Mark, "A Conceptual Model for Vehicle Navigation Systems," First Vehicle Navigation and Information System Conference, Sep. 11-13, 1989, Toronto, Canada, 11 pages.

Burnett, "Usable Vehicle Navigation Systems: Are We There Yet?" *Vehicle Electronic Systems 2000*, Jun. 29-30, 2000, 3.1.1-3.1.12.

"New Handsets Strut Their Stuff At Wireless '99," Internet: URL: <http://findarticles.com/p/articles/mi.sub.--m0BMD/is.sub.--1999.sub.--Feb-.sub.--11/ai.sub.--n27547656/> downloaded from Internet on Feb. 11, 1999, 3 pages.

Green; et al., "Suggested Human Factors Design Guidelines for Driver Information Systems," Technical Report UMTRI-93-21, Nov. 1993, 119 pages.

Tijerina; et al., "Driver Workload Assessment of Route Guidance System Destination Entry While Driving: A Test Track Study," *Proceedings of the 5th ITS World Congress*, Oct. 12-16, 1998, Seoul, Korea, 9 pages.

Muraskin, "Two-Minute Warnings for School Bus Riders," [retrieved on Feb. 27, 2013] Internet: URL: <http://www.embedded.com/electronics-news/4129835/TWO-MINUTE-WARNINGS-FOR-SCHOOL-BUS-RIDERS# Jul. 1, 1999, 2 pages>.

Kreller; et al., "A Mobile-Aware City Guide Application," *ACTS Mobile Communication Summit*, 1998, Rhodes, Greece, 7 pages.

Pascoe; et al., "Developing Personal Technology for the Field," *Personal Technologies*, 1998, 2:28-36.

Tebbutt, "Dial your way out of the woods," *The Australian*, Feb. 2000, 1 page.

Tso; et al., "Always on, Always Connected Mobile Computing," *Mobile Communications Operation—Mobile Handheld Products Group*, 1996, pp. 918-924.

Abowd; et al., "Context-awareness in wearable and ubiquitous computing," *1st International Symposium on Wearable Computers*, Oct. 13-14, 1997, Cambridge, MA, 9 pages.

Cheverst; et al., "The Support of Mobile-Awareness in Collaborative Groupware," *Personal Technologies*, 1999, 3:33-42.

Cheverst; et al., "Exploiting Context to Support Social Awareness and Social Navigation," *SIGGROUP Bulletin* Dec. 2000, 21(3):43-48.

Cheverst; et al., "Services to Support Consistency in Mobile Collaborative Applications," *Proc. 3rd International Workshop on Services in Distributed Networked Environments*, 1996, 8 pages.

Costa; et al., "Experiments with Reflective Middleware," *Proceedings of the ECOOP'98 Workshop on Reflective Object-Oriented Programming and Systems*, *ECOOP'98 Workshop Reader*, 1998, 13 pages.

U.S. Appl. No. 60/471,743, filed May 20, 2003. First named inventor: Edmund J. Fish. Entitled, "Presence and Geo-Location Information for Mobile Devices and Computing Devices."

U.S. Appl. No. 60/474,207, filed May 30, 2003. First named inventor: Stephen Vaughan Murphy. Entitled, "Spoken User Identifier."

U.S. Appl. No. 60/480,532, filed Jun. 23, 2003. First named inventor: Ho, David YC. Entitled, "Game to Fame—An Internet Game that helps players become famous."

U.S. Appl. No. 60/482,362, filed Jun. 25, 2003. First named inventor: Steve Kirchmeier. Entitled, "Telephony notification system."

U.S. Appl. No. 60/488,399, filed Jul. 21, 2003. First named inventor: Andrew Weaver. Entitled, "Multiple Personalities."

U.S. Appl. No. 60/488,638, filed Jul. 18, 2003. First named inventor: F. Craig Farrill. Entitled, "Real-Time Exchange."

U.S. Appl. No. 60/488,784, filed Jul. 22, 2003. First named inventor: Kreft. Entitled, "Improved Information Mapping Program."

U.S. Appl. No. 60/492,650, filed Aug. 5, 2003. First named inventor: Bruce D. Lawler. Entitled, "CDMA Press-to-Talk (P2T) Proof-of-Concept Demonstration."

U.S. Appl. No. 60/493,704, filed Aug. 8, 2003. First named inventor: Michael A. Sheha. Entitled, "Method and System for Collecting, Synchronizing, and Reporting Telecommunication Call Events and Work Flow Related Information."

U.S. Appl. No. 60/494,644, filed Aug. 11, 2003. First named inventor: Konstantin Othmer. Entitled, "Bandwidth Usage Optimization and Enhanced Performance for Wireless Networks."

U.S. Appl. No. 60/503,260, filed Sep. 16, 2003. First named inventor: Steve Kirchmeier. Entitled, "Telephony notification system."

U.S. Appl. No. 60/503,530, filed Sep. 16, 2003. First named inventor: William J. Sacco. Entitled, "Method and System of Rule-Based Triage."

U.S. Appl. No. 60/507,110, filed Oct. 1, 2003. First named inventor: Robert Khedour. Entitled, "Portable internet-linked subscription-capable audio-visual player apparatus and system and method for distribution and use thereof."

U.S. Appl. No. 60/512,852, filed Oct. 22, 2003. First named inventor: Patrick Blattner. Entitled, "Providing Video, Sound, or Animated Content with Instant Messages."

U.S. Appl. No. 60/516,351, filed Oct. 31, 2003. First named inventor: Habeman, William E.; et al. Entitled, "Instantaneous Wireless Communicative Display and Interface System."

U.S. Appl. No. 60/517,657, filed Nov. 5, 2003. First named inventor: Prabhakar R. Chitrapu. Entitled, "Mobile Wireless Presence and Situation Management System and Method."

U.S. Appl. No. 60/518,333, filed Nov. 10, 2003. First named inventor: Uri Levi. Entitled, "Wireless communication system."

U.S. Appl. No. 60/520,846, filed Nov. 18, 2003. First named inventor: Sugla. Entitled, "Method of Improving Location Accuracy, Achieving Seamless Tracking and Enabling Novel Applications Using Information From Multiple Location and Positioning Technologies."

U.S. Appl. No. 60/522,490, filed Oct. 6, 2004. First named inventor: Otman A. Basir. Entitled, "Spatial Calendar."

U.S. Appl. No. 60/524,343, filed Nov. 21, 2003. First named inventor: Poitras, Jean-Guy. Entitled, "Virtually Interlinked Collaborative Information System Based on Physical Locations of Tangible Real Property."

U.S. Appl. No. 60/525,420, filed Nov. 25, 2003. First named inventor: Lars Eilstrup Rasmussen. Entitled, "System for automatically integrating a digital map system with world wide web sites."

U.S. Appl. No. 60/528,055, filed Dec. 8, 2003. First named inventor: Doug Brams. Entitled, "Push to Talk User Interface."

U.S. Appl. No. 60/530,935, filed Dec. 19, 2003. First named inventor: Brian E. Smartt. Entitled, "Geocoding locations near a specified city."

U.S. Appl. No. 60/533,052, filed Dec. 30, 2003. First named inventor: Harper, et al. Entitled, "Universal Digital Music Licensing and Download System."

U.S. Appl. No. 60/540,505, filed Jan. 29, 2004. First named inventor: Mark Hull. Entitled, "System and Method for Social Networking."

U.S. Appl. No. 60/543,105, filed Feb. 9, 2004. First named inventor: Julian Bourne. Entitled, "Method and Computer System for Social Networking."

U.S. Appl. No. 60/544,209, filed Feb. 11, 2004. First named inventor: Richard Mgrdechian. Entitled, "Method and Apparatus for Wirelessly Communication and Messaging Between Previously Known and Unknown Parties."

U.S. Appl. No. 60/544,639, filed Feb. 13, 2004. First named inventor: Mark Hull. Entitled, "System and Method for Social Networking."

U.S. Appl. No. 60/546,687, filed Feb. 20, 2004. First named inventor: Brian Roundtree. Entitled, "Call Intercept Methods for Customer Self Support and Methods for Navigating Data Screens."

U.S. Appl. No. 60/549,484, filed Mar. 1, 2004. First named inventor: Richard Mgrdechian. Entitled, "Method and Apparatus for Wirelessly Communicating and Messaging Between Previously Known and Unknown Parties."

U.S. Appl. No. 60/549,937, filed Mar. 5, 2004. First named inventor: Barry Appelman. Entitled, "Passive Population of Buddy List form a Contact List."

(56)

References Cited

OTHER PUBLICATIONS

U.S. Appl. No. 60/550,262, filed Mar. 3, 2004. First named inventor: Richard Mgrdechian. Entitled, "Method and Apparatus for Wirelessly Communicating and Messaging Between Previously Known and Unknown Parties."

U.S. Appl. No. 60/550,300, filed Mar. 4, 2004. First named inventor: Tom Miltonberger. Entitled, "Method and System to Facilitate Geo-Location and Geo-Compliance Utilizing a Client Agent."

U.S. Appl. No. 60/552,406, filed Mar. 10, 2004. First named inventor: Greg Tseng. Entitled, "Enhancing virally marketed facilities."

U.S. Appl. No. 60/552,718, filed Mar. 15, 2004. First named inventor: Jeremy Liew. Entitled, "Social Networks."

U.S. Appl. No. 60/553,240, filed Mar. 15, 2004. First named inventor: Isaias Sudit; and Title: "Telephone User Interface for Efficient Self-Location of Mobile Phone".

U.S. Appl. No. 60/553,241, filed Mar. 15, 2004. First named inventor: Isaias, Sudit; and Title: "Meet Function for Telephone Auto Location System Based on Geographic Location and User Profiles".

U.S. Appl. No. 60/555,501, filed Mar. 22, 2004. First named inventor: Jens Eilstrup Rasmussen. Entitled, "Sub-Pixel Bitmaps and Their Use in Generating, Storing and Displaying Maps."

U.S. Appl. No. 60/560,087, filed Apr. 6, 2004. First named inventor: Cesar Cabral. Entitled, "Method and system for traffic management between a vehicle and a remote location."

U.S. Appl. No. 60/560,468, filed Apr. 7, 2004. First named inventor: Brian Lawler. Entitled, "Trust-metric network methods and apparatus."

U.S. Appl. No. 60/562,785, filed Apr. 15, 2004. First named inventor: Brian Wilson. Entitled, "System for Providing Location-Based Services in a Wireless Network, Such as Locating Sets of Desired Locations."

U.S. Appl. No. 60/566,644, filed Apr. 29, 2004. First named inventor: John N. Gross. Entitled, "System & method of identifying and predicting innovation dissemination."

U.S. Appl. No. 60/567,598, filed May 3, 2004. First named inventor: Klassen, Gerhard D. Entitled, "System and method for interrupt control on a handheld device."

U.S. Appl. No. 60/567,946, filed May 3, 2004. First named inventor: Jens Eilstrup Rasmussen. Entitled, "An Image Tile-Based, Digital Mapping System for the World Wide Web."

U.S. Appl. No. 60/568,482, filed May 6, 2004. First named inventor: Nathan Norfleet Eagle. Entitled, "Combined Short Range Radio Network and Cellular Telephone Network for Interpersonal Communications."

U.S. Appl. No. 60/569,953, filed May 11, 2004. First named inventor: Ravi Ayyasamy. Entitled, "Press to Talk Client Application Programming Interface (PCAPI)."

U.S. Appl. No. 60/570,410, filed May 12, 2004. First named inventor: Dennis R Crowley. Entitled, "Location-Based Social Software for Mobile Devices."

U.S. Appl. No. 60/571,075, filed May 14, 2004. First named inventor: Krishnakant Patel. Entitled, "Roaming Gateway for Support of Advanced Voice Services While Roaming."

U.S. Appl. No. 60/573,059, filed May 21, 2004. First named inventor: Krishnakant Patel. Entitled, "SMSC Bypass (SB) for Expedited Presence Messaging."

U.S. Appl. No. 60/573,780, filed May 24, 2004. First named inventor: Krishnakant Patel. "SIM Toolkit."

U.S. Appl. No. 60/654,951, filed Feb. 23, 2005. First named inventor: Harper, Gregory W. Entitled, "Systems and Methods for Storing Digital Content on Portable Devices."

U.S. Appl. No. 60/656,642, filed Feb. 25, 2005. First named inventor: Tony F. Rodriguez. Entitled, "Digital asset management, targeted searching and desktop searching using digital watermarks."

U.S. Appl. No. 60/657,222, filed Feb. 28, 2005. First named inventor: Ian Rogers. Entitled, "A System and Method for Delivering Media over a Network."

U.S. Appl. No. 60/658,086, filed Mar. 3, 2005. First named inventor: Michael Keith Dery. Entitled, "Cellular Telephone Tracking System Employing a GPS Receiver."

U.S. Appl. No. 60/658,312 filed Mar. 3, 2005. First named inventor: Andre Gueziec. Entitled, "7-Day traffic forecasts and trip advice."

U.S. Appl. No. 60/658,328, filed Mar. 2, 2005. First named inventor: Robertson; et al. Entitled, "System and method for managing user interaction data in a networked environment."

U.S. Appl. No. 60/659,643, filed Mar. 5, 2005. First named inventor: Sheha; Michael A.; et al. Entitled, "Method and System for Identifying and Defining Geofences."

U.S. Appl. No. 60/660,111, filed Mar. 8, 2005. First named inventor: Ching-Fang Lin. Entitled, "Interruption free navigator."

U.S. Appl. No. 60/661,056, filed Mar. 13, 2005. First named inventor: Kevin McKenzie. Entitled, "Method and System for Providing Security During Data Transmission over Wireless and Wired Network Connections."

U.S. Appl. No. 60/666,424, filed Mar. 30, 2005. First named inventor: Krishnakant Patel. Entitled, "Technique for Implementing Advanced Voice Services Using an Unstructured Supplementary Service Data (USSD) Interface."

U.S. Appl. No. 60/667,491, filed Apr. 1, 2005. First named inventor: Ching-Fang Lin. Entitled, "Interruption free navigator."

U.S. Appl. No. 60/266,559, filed Feb. 5, 2001. First named inventor: Athanasios Diacakis. Entitled, "Presence and availability management system."

U.S. Appl. No. 60/268,473 filed, Feb. 12, 2001. First named inventor: Woody Denman. Entitled, "Sip-Based Push-to-Talk (PTT) Service."

U.S. Appl. No. 60/269,506, filed Feb. 16, 2001. First named inventor: Kevin Buckham. Entitled, "Monitoring and controlling access to wireless location information for group based and other applications."

U.S. Appl. No. 60/274,453, filed Mar. 9, 2001. First named inventor: Heikki Huomo. Entitled, "System, mobile station and method for managing context-related information."

U.S. Appl. No. 60/277,347, filed Mar. 19, 2001. First named inventor: Fano, Andrew E.; et al. Entitled, "Mobile valet."

U.S. Appl. No. 60/279,401, filed Mar. 28, 2001. First named inventor: Raymond J. Menard. Entitled, "Variable Distance RF Tag Disclosure."

U.S. Appl. No. 60/279,513 filed Mar. 28, 2001. First named inventor: Raymond J. Menard. Entitled, "Range and Bearing Indicator for Wireless Device."

U.S. Appl. No. 60/279,671, filed Mar. 30, 2001. First named inventor: H. Britton Sanderford Jr. Entitled, "Enhanced wireless packet data communication system, method and apparatus applicable to both wide area networks and local area networks."

U.S. Appl. No. 60/281,038, filed Apr. 2, 2001. First named inventor: Fano, Andrew E.; et al. Entitled, "Mobile valet."

U.S. Appl. No. 60/282,205, filed Apr. 6, 2001. First named inventor: Kevin C. Jones. Entitled, "Digital asset management and linking media signals with related data using watermarks."

U.S. Appl. No. 60/283,929, filed Apr. 17, 2001. First named inventor: Steinbach, Galia ; et al. Entitled, "Beyondguide™ method and system."

U.S. Appl. No. 60/285,032, filed Apr. 19, 2001. First named inventor: Curtis A. Vock. Entitled, "Event Monitoring Systems and Methods."

U.S. Appl. No. 60/286,916, filed Apr. 27, 2001. First named inventor: Eric A. Portman. Entitled, "Location Based Services."

U.S. Appl. No. 60/289,586, filed May 9, 2001. First named inventor: Philip Klein. Entitled, "Preprocessing an Undirected Planar Network to Enable Fast Approximate Distance Queries."

U.S. Appl. No. 60/301,567, filed Jun. 28, 2001. First named inventor: Woody Denman. Entitled, "SIP-Based Push-to-Talk (PTT) Service."

U.S. Appl. No. 60/303,019, filed Jul. 5, 2001. First named inventor: Priya Viswanath. Entitled, "Passively tracking mobile subscribers by monitoring wireless network messages."

U.S. Appl. No. 60/303,615, filed Jul. 6, 2001. First named inventor: Randolph A. Jaramillo. Entitled, "Systems for Solving Challenges in Telecom Sales and Marketing."

U.S. Appl. No. 60/305,580, filed Jul. 16, 2001. First named inventor: Scott Notes. Entitled, "Dynamic Polling Optimization Server."

U.S. Appl. No. 60/305,975, filed Jul. 17, 2001. First named inventor: Sheha; et al. Entitled, "Position determination system."

(56)

References Cited

OTHER PUBLICATIONS

- U.S. Appl. No. 60/313,010, filed Aug. 20, 2001. First named inventor: Sheha; et al. Entitled, "Point of interest spatial rating search method and system."
- U.S. Appl. No. 60/318,738, filed Sep. 12, 2001. First named inventor: Daubert; et al. Entitled, "High resolution tracking of mobile assets."
- U.S. Appl. No. 60/319,162, filed Apr. 2, 2002. First named inventor: Randazzo. Entitled, "NAV-Cell Pier to Pier GPS."
- U.S. Appl. No. 60/319,769, filed Dec. 11, 2002. First named inventor: Randazzo. Entitled, "Marine GPScell."
- U.S. Appl. No. 60/323,601, filed Sep. 20, 2001. First named inventor: Curtis A. Vock. Entitled, "Event Monitoring Systems and Methods."
- U.S. Appl. No. 60/327,327, filed Oct. 4, 2001. First named inventor: Stephen Michael Palik. Entitled, "Machine for providing a dynamic database of geographic location information for a plurality of wireless communications device and process for making same."
- U.S. Appl. No. 60/335,203, filed Oct. 23, 2001. First named inventor: Mark J. Reed. Entitled, "Machine for providing a directional assistance network and process for same."
- U.S. Appl. No. 60/337,945, filed Nov. 9, 2001. First named inventor: McCarthy; et al. Entitled, "Network text messaging organized by threads."
- U.S. Appl. No. 60/349,251, filed Jan. 18, 2002. First named inventor: Larry Lu. Entitled, "Calendar Overlays."
- U.S. Appl. No. 60/351,935, filed Jan. 24, 2002. First named inventor: Ryan Steelberg. Entitled, "RF Delivery."
- U.S. Appl. No. 60/352,761, filed Jan. 29, 2002. First named inventor: Mark Jefferson Reed. Entitled, "Machine for providing a wireless communications device location tracking system and process for making same."
- U.S. Appl. No. 60/354,284, filed Feb. 1, 2002. First named inventor: Spriestersbach; et al. Entitled, "Integrating context information into enterprise applications for mobile applications."
- U.S. Appl. No. 60/357,240, filed Feb. 14, 2002. First named inventor: Andrew Charles Zmolek. Entitled, "Presence Tracking and Namespace Interconnection Techniques."
- U.S. Appl. No. 60/359,792, filed Feb. 26, 2002. First named inventor: Scott Notes. Entitled, "Minimizing Mobile Location Lookups via Intelligent Scheduling."
- U.S. Appl. No. 60/359,793, filed Feb. 26, 2002. First named inventor: Scott Notes. Entitled, "Computing Location Updates for Applications Requiring Location-Based Triggering."
- U.S. Appl. No. 60/360,527, filed Feb. 28, 2002. First named inventor: Phillip Klein. Entitled, "System for Multi-User Location Based Alerts."
- U.S. Appl. No. 60/360,737, filed Mar. 1, 2002. First named inventor: Michael A. Sheha. Entitled, "Method and Apparatus for Sending, Retrieving, and Planning Location Relevant Information."
- U.S. Appl. No. 60/361,380, filed Mar. 1, 2002. First named inventor: Richard W. Graham. Entitled, "A System and Method to Provide Security in a Network Based on Device Location Information."
- U.S. Appl. No. 60/361,419, filed Mar. 1, 2002. First named inventor: John J. Roesse. Entitled, "A System for Network Definition Based on Device Location."
- U.S. Appl. No. 60/361,420, filed Mar. 1, 2002. First named inventor: Richard W. Graham. Entitled, "Systems and Methods to Define Location of a Network Device or a Networked Device."
- U.S. Appl. No. 60/361,421, filed Mar. 1, 2002. First named inventor: John J. Roesse. Entitled, "A System to Regulate Access as a Function of Device Location."
- U.S. Appl. No. 60/362,155, filed Mar. 5, 2002. First named inventor: Andre Gueziec. Entitled, "Personalized road traffic information dissemination."
- U.S. Appl. No. 60/365,104, filed Mar. 18, 2002. First named inventor: Christopher J. Hall. Entitled, "An Alternative Solution to the Problem of the Geolocating a Portable Radio Transmitter."
- U.S. Appl. No. 60/365,244, filed Mar. 18, 2002. First named inventor: Athanassios Diacakis. Entitled, "System and method for providing voice-activated presence information."
- U.S. Appl. No. 60/367,527, filed Mar. 22, 2002. First named inventor: William J. Sacco. Entitled, "Method and System of Mass Casualty Triage Prioritization."
- U.S. Appl. No. 60/367,708, filed Mar. 28, 2002. First named inventor: Gordon John Hines. Entitled, "Location Derived Presence Information."
- U.S. Appl. No. 60/367,967, filed Mar. 25, 2002. First named inventor: Jeffrey D. Mullen. Entitled, "Systems and methods for locating cellular phones."
- U.S. Appl. No. 60/370,862, filed Apr. 8, 2002. First named inventor: Douglas G. Dempster. Entitled, "Method for graphical interaction with geographic databases for broadcast presentation."
- U.S. Appl. No. 60/371,941, filed Apr. 10, 2002. First named inventor: Michael A. Sheha. Entitled, "Methods and System for Dynamic Estimation and Predictive Route Generation."
- U.S. Appl. No. 60/375,998, filed Apr. 24, 2002. First named inventor: Lau; et al. Entitled, "System, method and apparatus for acquiring, presenting, managing and using position information."
- U.S. Appl. No. 60/377,019, filed Apr. 30, 2002. First named inventor: Michael Pechatnikov. Entitled, "Real-time distribution of dynamic maps."
- Davies; et al., "Caches in the Air: Disseminating Tourist Information in the Guide System," Second IEEE Workshop on Mobile Computer Systems and Applications, Feb. 25-26, 1999, 9 pages.
- Drane and Rizos, "Role of Positioning Systems in ITS," Positioning Systems in Intelligent Transportation Systems, Dec. 1997, pp. 312, 346-349.
- Fischer; et al., "System Performance Evaluation of Mobile Positioning Methods," IEEE, Aug. 2002, pp. 1962-1966.
- Flinn and Satyanarayanan, "PowerScope: A Tool for Profiling the Energy Usage of Mobile Applications," Proc. WMCSA '99 Second IEEE Workshop on Mobile Computing Systems and Applications, Feb. 25-26, 1999, 9 pages.
- French and Driscoll, "Location Technologies for Its Emergency Notification and E911," Proc. 1996 National Technical Meeting of the Institute of Navigation, Jan. 22-24, 1996, pp. 355-359.
- Friday; et al., "Developing Adaptive Applications: The MOST Experience," J. Integrated Computer-Aided Engineering, 1999, 35 pages.
- Gunnarsson; et al., "Location Trial System for Mobile Phones," IEEE, 1998, pp. 2211-2216.
- Kovacs; et al., "Adaptive Mobile Access to Context-aware Services," Proc. ASAMA '99 Proc. First International Symposium on Agent Systems and Applications Third International Symposium on Mobile Agents, IEEE Computer Society Washington, DC, 1999, 12 pages.
- Kugler and Lechner, "Combined Use of GPS and LORAN-C in Integrated Navigation Systems," Fifth International Conference on Satellite Systems for Mobile Communications and Navigation, London, UK, May 13-15, 1996, pp. 199-207.
- Kyriazakos; et al., "Optimization of the Handover Algorithm based on the Position of the Mobile Terminals," Communications and Vehicular Technology, Oct. 2000, pp. 155-159.
- Bennett; et al., "Location-based services", Mar. 1, 2002, Downloaded: Feb. 24, 2013, <http://www.ibm.com/developerworks/ibm/library/i-libs/>, 7 pages.
- Persson; et al., "GeoNotes: a real-use study of a public location-aware community system (2002)", Dec. 2002, 10 pages.
- Munson; et al., "Location-based notification as a general-purpose service", Proceedings of the 2nd international workshop, WMC'02, Sep. 28, 2002, 5 pages.
- Stroud, "Minority Report Has Ad-ded Value", [online] Retrieved from the Internet on Mar. 3, 2013: URL: <http://www.wired.com/entertainment/music/news/2002/06/53555>, Jun. 29, 2002, 1 page.
- Barwise; et al., "Permission-Based Mobile Advertising", Journal of Interactive Marketing, vol. 16 / No. 1 / Winter 2002, pp. 14-24.
- Aalto; Etal., "Bluetooth and WAP Push Based Location-Aware Mobile Advertising System", MobiSYS'04, Jun. 6-9, 2004, 10 pages.
- Kolmel; et al., "Location Based Advertising" The First International Conference on Mobile Business, M-Business Conference 2002, 7 pages.
- Bulander; et al., "Enabling Personalized and Context Sensitive Mobile Advertising While Guaranteeing Data Protection", Proceedings of the EURO-mGOV 2005, Brighton, KMobile Government International LLC, pp. 445-454.

(56)

References Cited

OTHER PUBLICATIONS

- Rao; et al., "Evolution of Mobile Location-based Services", Communications of the ACM Dec. 2003/vol. 46, No. 12, pp. 61-65.
- Ko; et al., "Geocasting in Mobile Ad Hoc Networks: Location-Based Multicast Algorithms", International Conference on Mobile Computing and Networking, MobiCom'98, 1998, 10 pages.
- Varshney, "Location Management for Mobile Commerce Applications in Wireless Internet Environment", ACM Transactions on Internet Technology, vol. 3, No. 3, Aug. 2003, pp. 236-255.
- Ko; et al., "Location-Aided Routing (LAR) in mobile ad hoc networks", Wireless Networks 6 (2000), pp. 307-321.
- Gratton, "M-commerce: The Notion of Consumer Consent in Receiving Location-Based Advertising", Canadian Journal of Law & Technology, vol. 1 No. 3, Nov. 2002, pp. 59-77.
- Corson; et al., "Mobile Ad hoc Networking (MANET): Routing Protocol Performance Issues and Evaluation Considerations", Request for Comments: 2501, The Internet Society, Jan. 1999, 12 pages.
- Perkins; et al., "Ad hoc On-Demand Distance Vector (AODV) Routing", Request for Comments: 3561, The Internet Society, Jul. 2003, 37 pages.
- Clausen; et al., "Optimized Link State Routing Protocol (OLSR)", Request for Comments: 3626, The Internet Society, Oct. 2003, 75 pages.
- Ogier; et al., "Topology Dissemination Based on Reverse-Path Forwarding (TBRPF)", Request for Comments: 3684, The Internet Society, Feb. 2004, 46 pages.
- Kaasinen, "User needs for location-aware mobile services", Pers Ubiquit Comput (2003), 7: pp. 70-79.
- Dimpfel; et al., "Integration and Content", ELBA (European Location Based Advertising), IST-2001-36530, 2002, 22 pages.
- "Location Based Advertising—Overview", ELBA (European Location Based Advertising), IST-2001-36530, Jun 30, 2002, 17 pages.
- Kölmel, "ELBA Location Based Advertising—Status", ELBA (European Location Based Advertising), IST-2001-36530, Sep. 2003, 21 pages.
- Porak, "ELBA Real Life scenarios of LBA"; M-Business 2003, Vienna 2003, 22 pages.
- Dimpfel, "Overview Technical Integration and Advertising Content Management", ELBA (European Location Based Advertising), IST-2001-36530, 2003, 8 pages.
- "ELBA—Project Summary", ELBA (European Location Based Advertising), 2002, 2 pages.
- U.S. Appl. No. 09/206,627, filed Dec. 7, 1998. First named inventor: Alvin C. Allen Jr. Entitled, "Apparatus and Method for Triggerable Location Reporting."
- U.S. Appl. No. 10/865,114, filed Jun. 9, 2004. First named inventor: Ricardo D. Craft. Entitled, "Aggregated Perceived Presence."
- U.S. Appl. No. 10/916,960, filed Aug. 11, 2004. First named inventor: Othmer; Konstantin. Entitled, "Systems and methods for populating a ticker with location-based content."
- U.S. Appl. No. 10/917,200, filed Aug. 11, 2004. First named inventor: Othmer. Entitled, "Bandwidth usage optimization and enhanced performance for wireless networks."
- U.S. Appl. No. 11/019,526, filed Dec. 23, 2004. First named inventor: Bill. Entitled, "Predicting an event at a location."
- U.S. Appl. No. 11/030,904, filed Jan. 10, 2005. First named inventor: Kurt Nosack. Entitled, "System and method for determining a nearest network resource using GPS coordinates."
- U.S. Appl. No. 11/063,096, filed Feb. 22, 2005. First named inventor: Ellenby; et al. Entitled, "Pointing systems for addressing objects."
- "U.S. Appl. No. 11/099,362, Non-Final Office Action mailed Aug. 28, 2006", 13 pgs.
- "U.S. Appl. No. 11/099,362, Notice of Allowance mailed Jun. 6, 2007", 7 pgs.
- "U.S. Appl. No. 11/099,362, Response Filed Jan. 29, 2007 to Non-Final Office Action mailed Aug. 28, 2006", 24 pgs.
- U.S. Appl. No. 09/365,748, filed Aug. 3, 1999. First named inventor: Michael David Bednarek. Entitled, "System and Method for Supporting Participant Specific Incentives and Promotions."
- U.S. Appl. No. 09/540,214, filed Mar. 31, 2000. First named inventor: Jay S. Walker. Entitled, "Method and apparatus for conducting a transaction based on brand indifference."
- U.S. Appl. No. 09/589,684, filed Jun. 7, 2000. First named inventor: Neeraj Jhanji. Entitled, "Improved Systems for Communicating Future Activity Information Among Mobile Internet Users and Methods Therefor."
- U.S. Appl. No. 09/589,685, filed Jun. 7, 2000. First named inventor: Neeraj Jhanji. Entitled, "Improved Systems for Communicating Future Activity Information Among Mobile Internet Users and Methods Therefor."
- "Buddy Locator." Jun. 11, 2003. http://www.halfbakery.com/idea/Buddy_20Locator.
- "Hansel and Gretel" A German folk tale recorded by the Brothers Grimm and published in 1812. Illustrated by Arthur Rackham in 1909. Specifically, we would like to cite the "white pebbles" and "bread crumbs" used as a form of tracking in the folk tale.
- "Mobile Phone Utility." Jan. 8, 2004. http://www.halfbakery.com/idea/mobile_20phone_20utility.
- "Mobile Proximity Link." Sep. 30, 2001. http://www.halfbakery.com/idea/Mobile_20Proximity_20Link.
- "Networks in Motion Named Semi-Finalist for Wireless LBS Challenge." Mar. 18, 2004. <http://www.tmcnet.com/usubmit/2004/Mar/1025200.htm>.
- "Proposal for Free, Open Source Cell Phone Location Service." Mar. 6, 2004. http://george.hotelling.net/90percent/geekery/proposal_for_free_open_source_cell_phone_location_service.php.
- "SignalSoft Corporation Has Been Awarded a Location-Based Services Patent." Apr. 27, 2001. http://www.cellular.co.za/news_2001/04282001-signalsoft-patent.htm.
- "Star Trek Communicator" the prop utilized in the Star Trek television series. The first appearance was in "The Cage" episode airing in 1964. The Science Fiction series was created by Gene Roddenberry. Want, Roy et al. "The Active Badge Location System." Olivetti Research Ltd., Cambridge, England. ACM Transactions on Information Systems (TOIS), vol. 10, Issue 1. Jan. 1992. 10 pages.
- "The Tetra System." Ashcom Systems Ltd.—Tetra Communications Networks. Feb. 1, 2011. 2 pages.
- (Editor) Saint-Andre, Peter; (Contributors) Adachi, Shin et al. "Liberty ID-SIS Presence Service Specification." Version 1.0-10. Liberty Alliance Project. Copyright 2005. 14 pages.
- "Complete Coverage—Unrivalled Coverage with Lower Costs." Nokia TB3 TETRA Base Station—Data Sheet. Copyright Nokia 2004. 2 pages.
- "Complete Nokia TETRA for Public Safety." Nokia Code: 11113. Copyright 2003 Nokia. 20 pages.
- Cuervo, F. et al. "Megaco Protocol Version 1.0." Network Working Group; Request for Comments: 3015; Obsoletes: 2885, 2886; Category: Standards Track. Copyright The Internet Society. Nov. 2000. 179 pages.
- Day, M. et al. "A Model for Presence and Instant Messaging." Network Working Group; Request for Comments: 2778; Category: Informational. Copyright The Internet Society. Feb. 2000. 17 pages.
- Groves, C. et al. "H.24B / MEGACO Registration Procedures." Network Working Group; Request for Comments: 5615; BCP:151; Category: Best Current Practice. Copyright IETF Trust and the persons identified as the document authors. Aug. 2009. 14 pages.
- "Improving TETRA Base Station Coverage with Revolutionary Radio Access Solution." White Paper. 0604 PMIR. Copyright Nokia 2004. 9 pages.
- Klyne, G. et al. "Date and Time on the Internet: Timestamps." Network Working Group; Request for Comments: 3339; Category: Standards Track. Copyright The Internet Society. Jul. 2002. 18 pages.
- Leighton, Paul "TETRA Security—2nd ETSI Security Workshop: Future Security." Jan. 16-17, 2007. Sophia-Antipolis, France. 31 pages.
- "Location Architecture Overview Requirements." Historic Version 1.0. "Open Mobile Alliance." OMA-RD-LOC_ArchOverview-V1_0-20041118-H. Nov. 18, 2004. 49 pages.
- Makelainen, Sami I. et al. "OMA IMPS (Previously Wireless Village)." A paper for instant messaging and presence-seminar, University of Helsinki. 2005. 12 pages.

(56)

References Cited

OTHER PUBLICATIONS

- "Network Wide TETRA Services." Press Backgrounder for Nokia. Sep. 2004. pp. 1-3.
- "Nokia NetAct for TETRA—Ensuring a Reliable and Always Available Service." Copyright Nokia 2001. 2 pages.
- "Operational Best Practices for Managing Trunked Land Mobile Radio Systems." PSWN—Public Safety Program Wireless Network. Final Version. May 2003. 77 pages
- Salinas, Arturo. "Advantages and Disadvantages of Using Presence Service." Helsinki University of Technology. May 4-5, 2006. 8 pages.
- "TETRA is the Winner in Bahrain." Nokia TETRA is proving its worth in Bahrain, including the challenge of the first Middle Eastern Grand Prix. Copyright 2004. 2 pages.
- "TETRA Touch." Nokia TETRA customer newsletter. www.nokia.com/tetra_touch. vol. 4. 2004. 28 pages.
- "What is TETRA?" TETRA Quick Guide. Press Backgrounder. Sep. 2004. 9 pages.
- Wireless Village—The Mobile IMPS Initiative. Client-Server Protocol Session and Transactions. Version 1.1. WV Internal Tracking No. WV-022. Copyright 2001-2002 Ericsson, Motorola and Nokia. Cover page, i-ii, pp. 1-92.
- Wireless Village—The Mobile IMPS Initiative. Command Line Protocol. Version 1.1. WV Internal Tracking No. WV-031. Copyright 2001-2002. Ericsson, Motorola and Nokia. Cover page, i-iii, pp. 1-31.
- Wireless Village—The Mobile IMPS Initiative. Presence Attributes. Version 1.1. WV Internal Tracking No. WV-029. Copyright 2001-2002. Ericsson, Motorola and Nokia. Cover page, i-ii, pp. 1-23.
- Wireless Village—The Mobile IMPS Initiative. SSP—Server to Server Protocol Semantics Document. Version 1.1. WV Internal Tracking No. WV-032. Copyright 2001-2002 Ericsson, Motorola and Nokia. Cover page, i-ix, pp. 1-125.
- Wireless Village—The Mobile IMPS Initiative. System Architecture Model. Version 1.1. WV Tracking No. WV-020. Copyright 2001-2002 Ericsson, Motorola and Nokia. Cover page, i-ii, pp. 1-10.
- "Wireless Village Initiative Announces Intent to Join the Open Mobile Alliance." Business, Wire (Vancouver, Canada), Business & High-Tech Editors. Jun. 13, 2002. 3 pages.
- "Location Based Services." GSM Association, Permanent Reference Document: Se.23. Version 3.1.0. Jan. 2003. 75 pages.
- "Location-Based Services System (LBSS)." 3GPP2 S.R0019 v 1.0.0. Stage 1 Description. 3rd Generation Partnership Project 2 "3GPP2." Sep. 22, 2000. 56 pages.
- "Senior Projects Garner Awards at Spring 2001 Design Expo." Department of Computer Science, University of Colorado at Boulder. 2004. 1 page.
- "The World in Your Hand." Newsweek. May 31, 1999. 1 page.
- Bahl, Paramvir et al. "Radar: An In-Building RF-based User Location and Tracking System." IEEE INFOCOM. 2000. pp. 775-784.
- Barkhuus, Louise. "Privacy in Location-Based Services, Concern vs. Coolness." Department of Design and Use of IT, The IT University of Copenhagen. Sep. 2004. 6 pages.
- Beresford, Alastair R. et al. "Location Privacy in Pervasive Computing." Published by the IEEE CS and IEEE Communications Society. Jan.-Mar. 2003. pp. 46-55.
- Bisdikian, C. et al. "Enabling Location-Based Services Through Passive Monitoring Techniques: Mobile Positioning with the HInTON Locator Probe." A White Paper from Telesoft Technologies, 1st Workshop on Mobile Commerce. 2001. pp. 1-20.
- Burak, Assaf et al. "Usage Patterns of FriendZone—Mobile Location-Based Community Services." MUM '04 Proceedings of the 3rd International Conference on Mobile and Ubiquitous Multimedia. 2004. 8 pages.
- Colbert, Martin. "A Diary Study of Rendezvousing: Implications for Position-Aware Computing and Communications for the General Public." Kingston University, Group '01. ACM Press. Sep. 30-Oct. 3, 2001. 10 pages.
- Cuellar, J. et al. "Geopriv Requirements." Internet Draft. Jun. 2002. pp. 1-23.
- Cuellar, J. et al. "Geopriv Requirements." Internet Draft. Nov. 2001. pp. 1-13.
- Dobson, Jerome E. et al. "Geoslavery." IEEE Technology and Society Magazine, Spring 2003. pp. 47-52.
- Gruteser, Marco et al. "Anonymous Usage of Location-Based Services Through Spatial and Temporal Cloaking." Department of Computer Science, University of Colorado at Boulder. Proc. MobiSys 2003, ACM Press. 12 pages.
- Jose, Rui et al. "Scalable and Flexible Location-Based Services for Ubiquitous Information Access." First International Symposium on Handheld and Ubiquitous Computing, HUC'99, Karlsruhe, Germany. Sep. 27-29, 1999. Published by Springer, Lecture Notes in Computer Science. vol. 1707. pp. 1-15.
- Kottman, Cliff. "Geospatial Sciences in support of Digital Government." Open GIS Consortium, Inc. Nov. 16, 2000. 36 pages.
- U.S. Appl. No. 60/046,020, filed May 9, 1997. First named inventor: Clayton R. Karmel. Entitled, "Positioning system using packet radio to provide differential global positioning satellite corrections and information relative to a position."
- U.S. Appl. No. 60/046,021, filed May 9, 1997. First named inventor: Clayton R. Karmel. Entitled, "Positioning system using packet radio to determine position and to obtain information relative to a position."
- U.S. Appl. No. 60/046,400, filed May 13, 1997. First named inventor: Scott R. Jamison. Entitled, "Automated touring information systems and methods."
- U.S. Appl. No. 60/058,623, filed Sep. 11, 1997. First named inventor: Harold L. Peterson. Entitled, "Software Vending, Delivery, and Maintenance System."
- U.S. Appl. No. 60/066,653, filed Nov. 19, 1997. First named inventor: Steven Baker. Entitled, "Method and apparatus for distributing location-based messages in a wireless communication network."
- U.S. Appl. No. 60/068,775, filed Dec. 24, 1997. First named inventor: Wendell Alumbaugh. Entitled, "Travel guide."
- U.S. Appl. No. 60/072,090, filed Jan. 21, 1998. First named inventor: Craig A. Owensby. Entitled, "Method of Subscriber-Targeted Advertising for Mobile Personal Communications Services."
- U.S. Appl. No. 60/072,757, filed Jan. 27, 1998. First named inventor: Steven M. Hoffberg. Entitled, "Mobile communication device."
- U.S. Appl. No. 60/097,932, filed Aug. 25, 1998. First named inventor: Matthew G. Pallakoff. Entitled, "System designed to facilitate team buying."
- U.S. Appl. No. 60/097,933, filed Aug. 25, 1998. First named inventor: Matt Pallakoff. Entitled, "Network system designed to facilitate offering, selling and purchasing goods and services."
- U.S. Appl. No. 60/105,493, filed Oct. 23, 1998. First named inventor: Raymond J. Menard. Entitled, "Low Power Two-Way Long Range Security System."
- U.S. Appl. No. 60/106,816, filed Nov. 3, 1998. First named inventor: James Fitch. Entitled, "Data Fusion for Wireless Location-Based Applications."
- U.S. Appl. No. 60/113,167, filed Dec. 21, 1998. First named inventor: Charles C. Cheng. Entitled, "Method for Location Based Asset Management."
- U.S. Appl. No. 60/115,074, filed Jan. 7, 1999. First named inventor: Harry E. Emerson, III. Entitled, "Enhanced Radio Graphic Data System."
- U.S. Appl. No. 60/123,821, filed Mar. 11, 1999. First named inventor: John D. Codignotto. Entitled, "Message publishing system and method."
- U.S. Appl. No. 60/123,882, filed Mar. 11, 1999. First named inventor: David S. Breed. Entitled, "Methods and Apparatus for Preventing Vehicle Accidents."
- U.S. Appl. No. 60/130,882, filed Apr. 23, 1999. First named inventor: Donald L. Fuchs. Entitled, "Method and Apparatus for Locating Mobile Receivers."
- U.S. Appl. No. 60/135,862, filed May 25, 1999. First named inventor: Raymond J. Menard. Entitled, "Bidirectional Wireless Detection System."
- U.S. Appl. No. 60/158,255, filed Oct. 5, 1999. First named inventor: Dave Michaelson. Entitled, "Ocean Bottom Proximity Warning Sensor."

(56)

References Cited

OTHER PUBLICATIONS

U.S. Appl. No. 60/160,326, filed Oct. 19, 1999. First named inventor: Michael L. Obradovich. Entitled, "Technique for Effective Navigation Based on User Preferences."

U.S. Appl. No. 60/162,333, filed Oct. 29, 1999. First named inventor: Hirohisa Tanaka. Entitled, "Method for Providing Matching and Introduction Services to Proximate Mobile Users and Service Providers."

U.S. Appl. No. 60/165,435, filed Nov. 15, 1999. First named inventor: Jay S. Walker. Entitled, "Uniseller Internet pricing."

U.S. Appl. No. 60/170,844, filed Dec. 14, 1999. First named inventor: Jhan. Entitled, "Improved Systems for Communication among Mobile Internet Users."

U.S. Appl. No. 60/184,248, filed Feb. 23, 2000. First named inventor: Robert M. Kalthoff. Entitled, "Locator system."

U.S. Appl. No. 60/184,799, filed Feb. 24, 2000. First named inventor: Jay S. Walker. Entitled, "Redemption feedback loop for priceline for gas."

U.S. Appl. No. 60/185,480, filed Feb. 28, 2000. First named inventor: C. Douglass Thomas. Entitled, "Method and System for Location Tracking."

U.S. Appl. No. 60/185,902, filed Feb. 29, 2000. First named inventor: John E. Boyd. Entitled, "A Computer-Based Networking Service and Method and Systems for Performing the Same."

U.S. Appl. No. 60/186,155, filed Feb. 29, 2000. First named inventor: Blumberg; et al. Entitled, "Global positioning-based real estate database access device and method."

U.S. Appl. No. 60/187,137, filed Mar. 6, 2000. First named inventor: Fisher; et al. Entitled, "ImageHub."

U.S. Appl. No. 60/191,779, filed Mar. 24, 2000. First named inventor: Robert L. Piccioni. Entitled, "System and Method for Automated Distribution of Law Enforcement Information."

U.S. Appl. No. 60/194,761, filed Apr. 3, 2000. First named inventor: Christopher Herringshaw. Entitled, "Method and Apparatus for Estimating Geographic Location of a Networked Entity."

U.S. Appl. No. 60/196,575, filed Apr. 11, 2000. First named inventor: Michael Obradovich. Entitled, "GPS Publication Application Server."

U.S. Appl. No. 60/199,528, filed Apr. 25, 2000. First named inventor: Todd Newville. Entitled, "Information Data Portal."

U.S. Appl. No. 60/199,551, filed Apr. 25, 2000. First named inventor: Cooper. Entitled, "System and method for proximity searching position information using a proximity parameter."

U.S. Appl. No. 60/202,147, filed May 5, 2000. First named inventor: Masoud Motamedi. Entitled, "Performance analysis tool for location systems."

U.S. Appl. No. 60/205,938, filed May 18, 2000. First named inventor: Mathur; et al. Entitled, "System and method for creating content and preferences in a collaborative fashion with privacy."

U.S. Appl. No. 60/210,682, filed Jun. 10, 2000. First named inventor: Hirohisa Tanaka. Entitled, "Method and System for Selectively Connecting Proximate Mobile Telecommunication Users Having Compatible Attributes."

U.S. Appl. No. 60/210,691, filed Jun. 10, 2000. First named inventor: Geoffrey R. Hendrey. Entitled, "Method and System for Selectively Connecting Proximate Mobile Telecommunication Users."

U.S. Appl. No. 60/212,155, filed Jun. 16, 2000. First named inventor: Tendler. Entitled, "Pager Activated GPS-Equipped Wireless Phone."

U.S. Appl. No. 60/214,197, filed Jun. 26, 2000. First named inventor: Philip J. Koopman Jr. Entitled, "Method and Apparatus for Automatically Initiating Telecommunication Connections to Nearby Transceivers."

U.S. Appl. No. 60/216,721, filed Jul. 7, 2000. First named inventor: Geoffrey R. Hendrey. Entitled, "Method and Apparatus for Facilitating Meetings Among Proximate Indirectly Related People."

U.S. Appl. No. 60/218,454, filed Jul. 14, 2000. First named inventor: Norman Mohi. Entitled, "Locating system and method."

U.S. Appl. No. 60/223,614, filed Aug. 7, 2000. First named inventor: Philip J. Koopman Jr. Entitled, "Method and System for Tracking Effectiveness of Mobile Telecommunication Advertisements."

U.S. Appl. No. 60/225,076, filed Aug. 14, 2000. First named inventor: Ashutosh Pande. Entitled, "Multi-mode global positioning system for use with wireless networks."

U.S. Appl. No. 60/228,102, filed Aug. 26, 2000. First named inventor: Thomas Black. Entitled, "Method and apparatus for restricting the assignment of VLANs."

U.S. Appl. No. 60/241,776, filed Oct. 18, 2000. First named inventor: Brad Doctor. Entitled, "Method and System to Determine a Geographical Location Associated with a Network Address."

U.S. Appl. No. 60/256,069, filed Dec. 15, 2000. First named inventor: Curtis A. Vock. Entitled, "Ubiquitous Movement Monitor Device."

U.S. Appl. No. 60/257,386, filed Dec. 22, 2000. First named inventor: Curtis A. Vock. Entitled, "Movement Monitoring Systems and Methods."

U.S. Appl. No. 60/259,271, filed Dec. 29, 2000. First named inventor: Curtis A. Vock. Entitled, "Movement Monitoring Systems and Methods."

U.S. Appl. No. 60/264,164, filed Jan. 24, 2001. First named inventor: Yi-chung Chao. Entitled, "Methods and Implementation for Improving Mobile User Position Accuracy and Information Input/Output Formats."

* cited by examiner

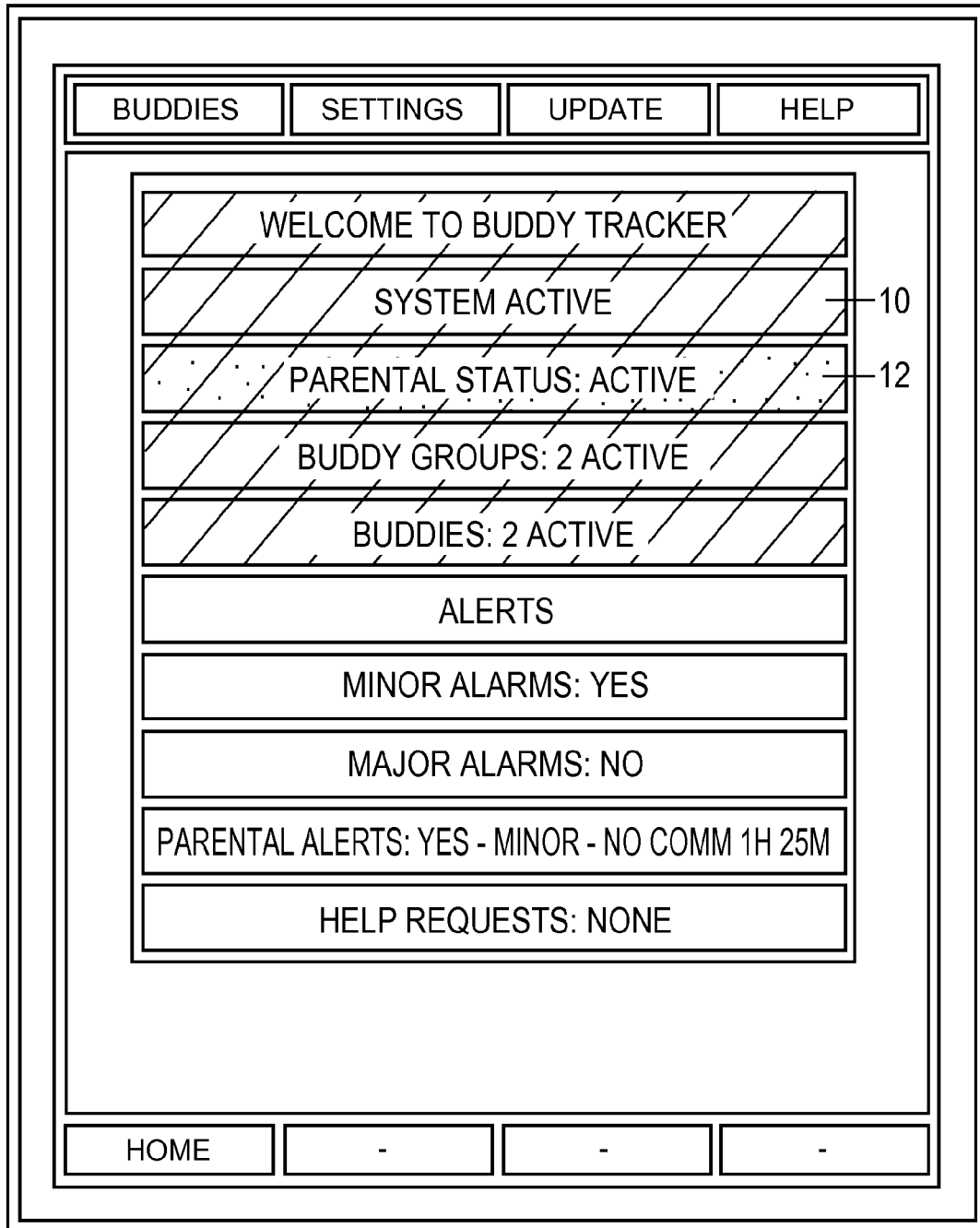

OPENING SCREEN

FIG. 1

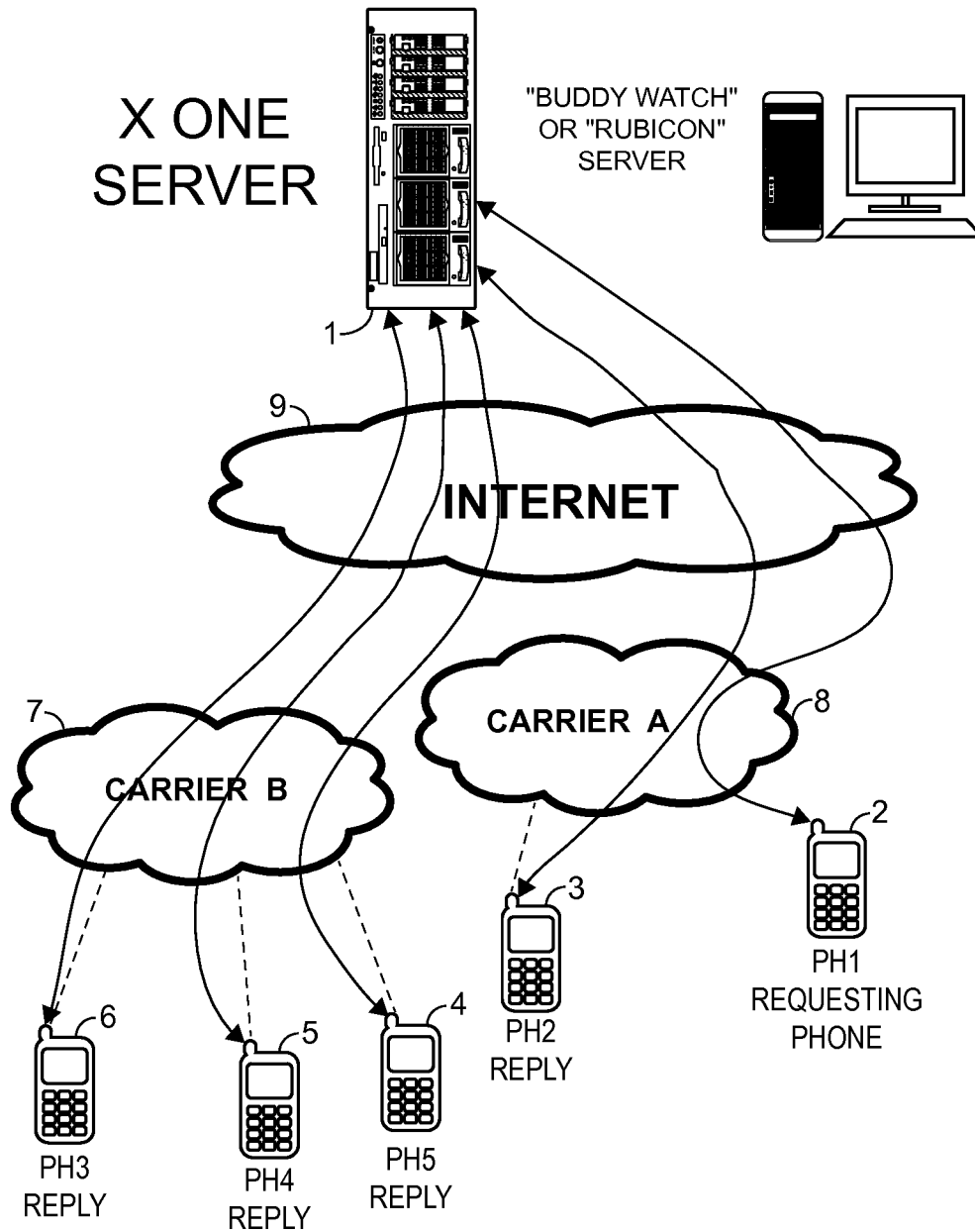
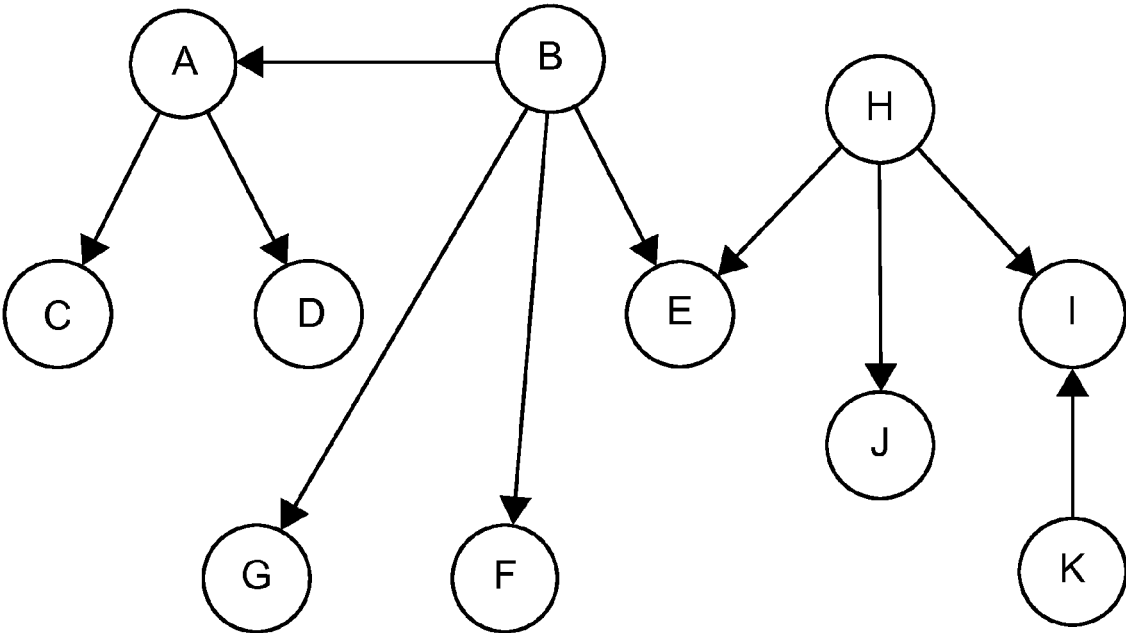

FIG. 2A



MATRIX OF BUDDY LIST

FIG. 2B

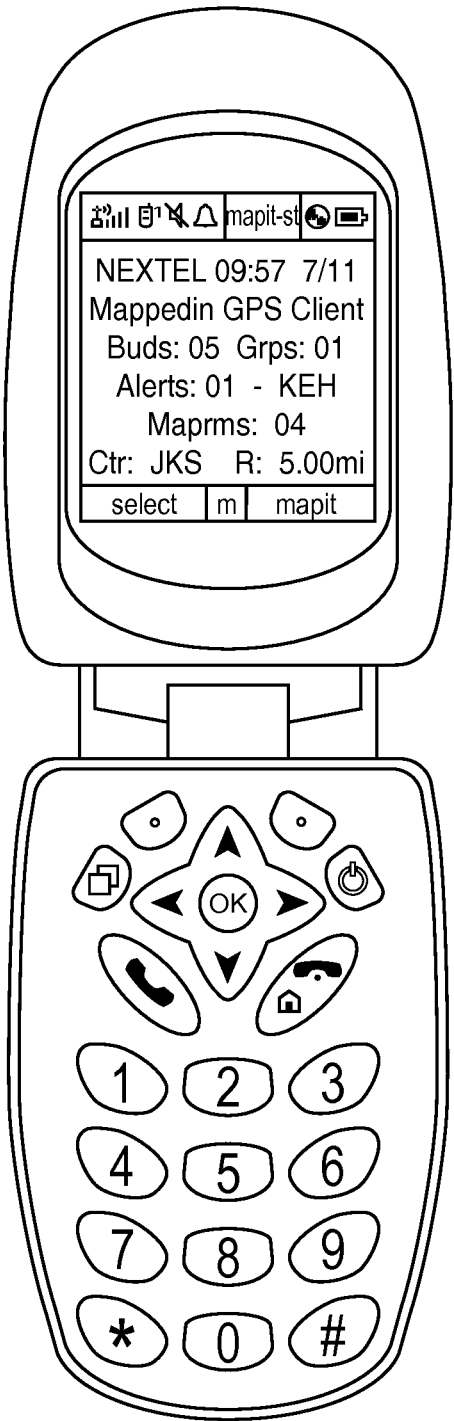

FIG. 2C

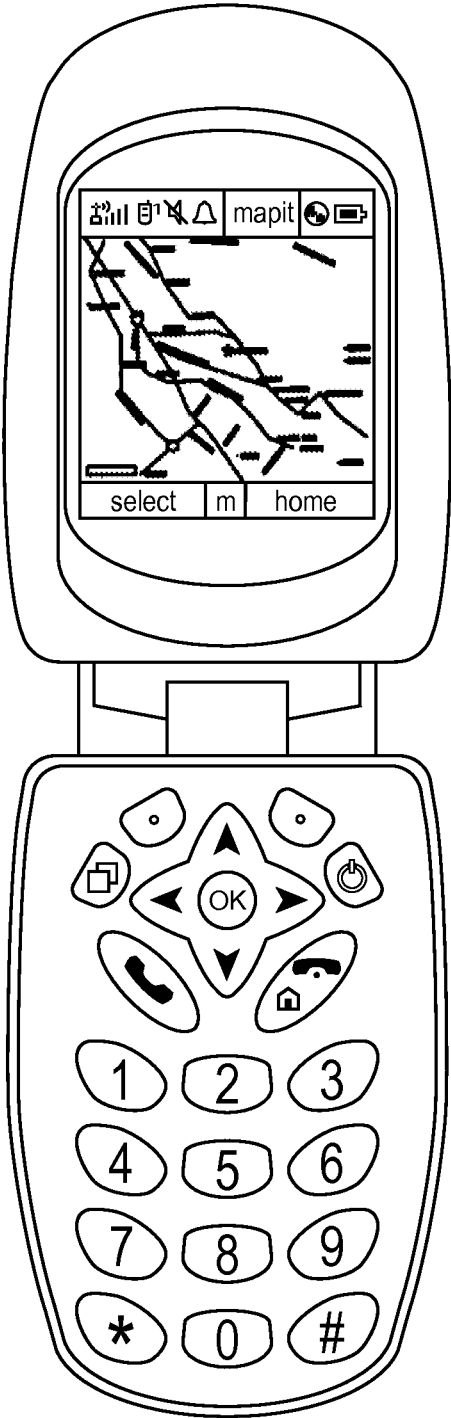

FIG. 2D

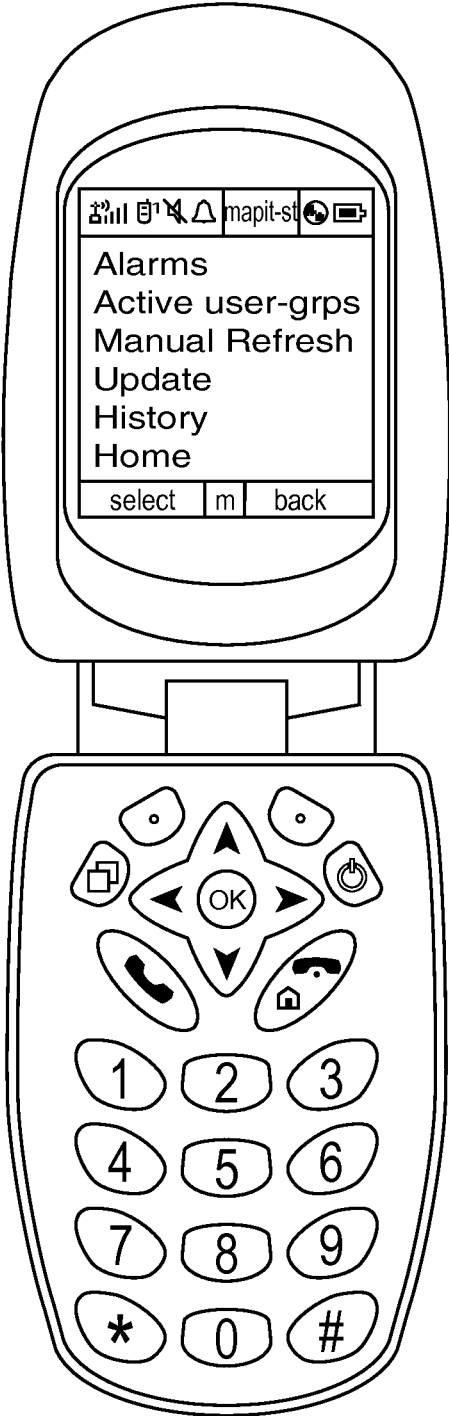

FIG. 2E

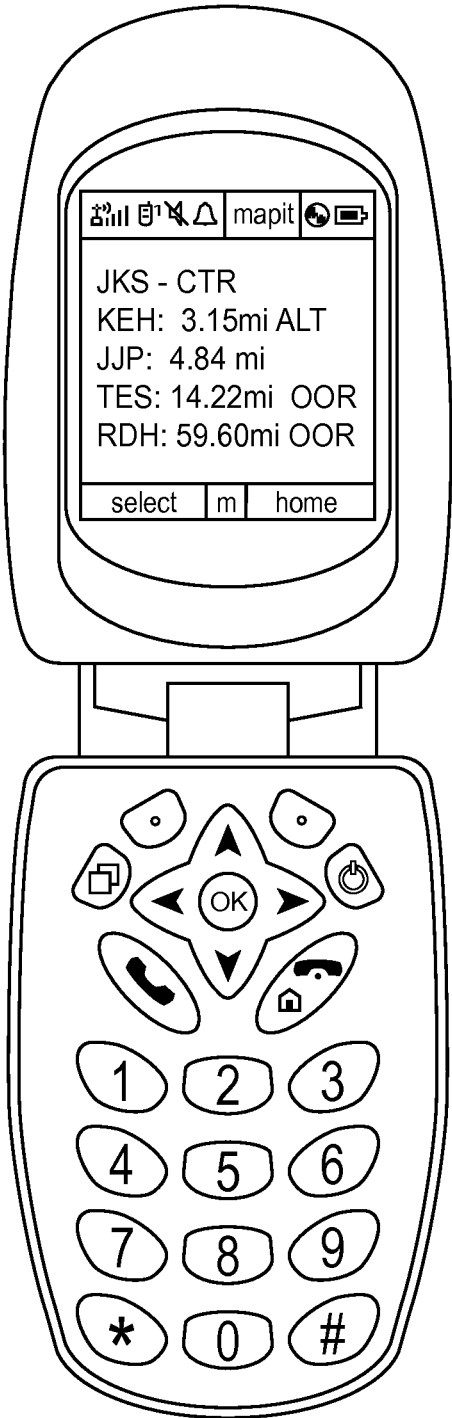
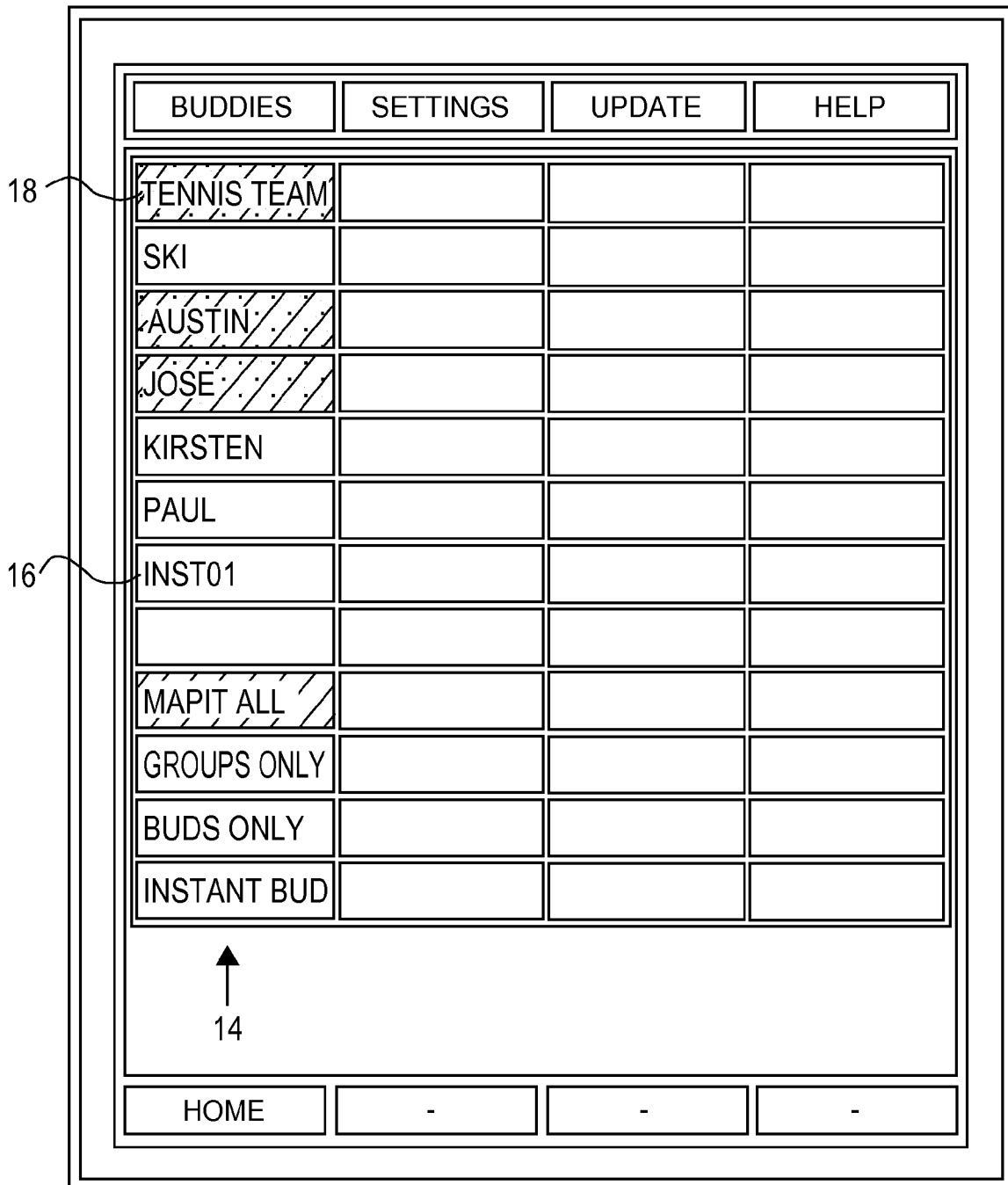
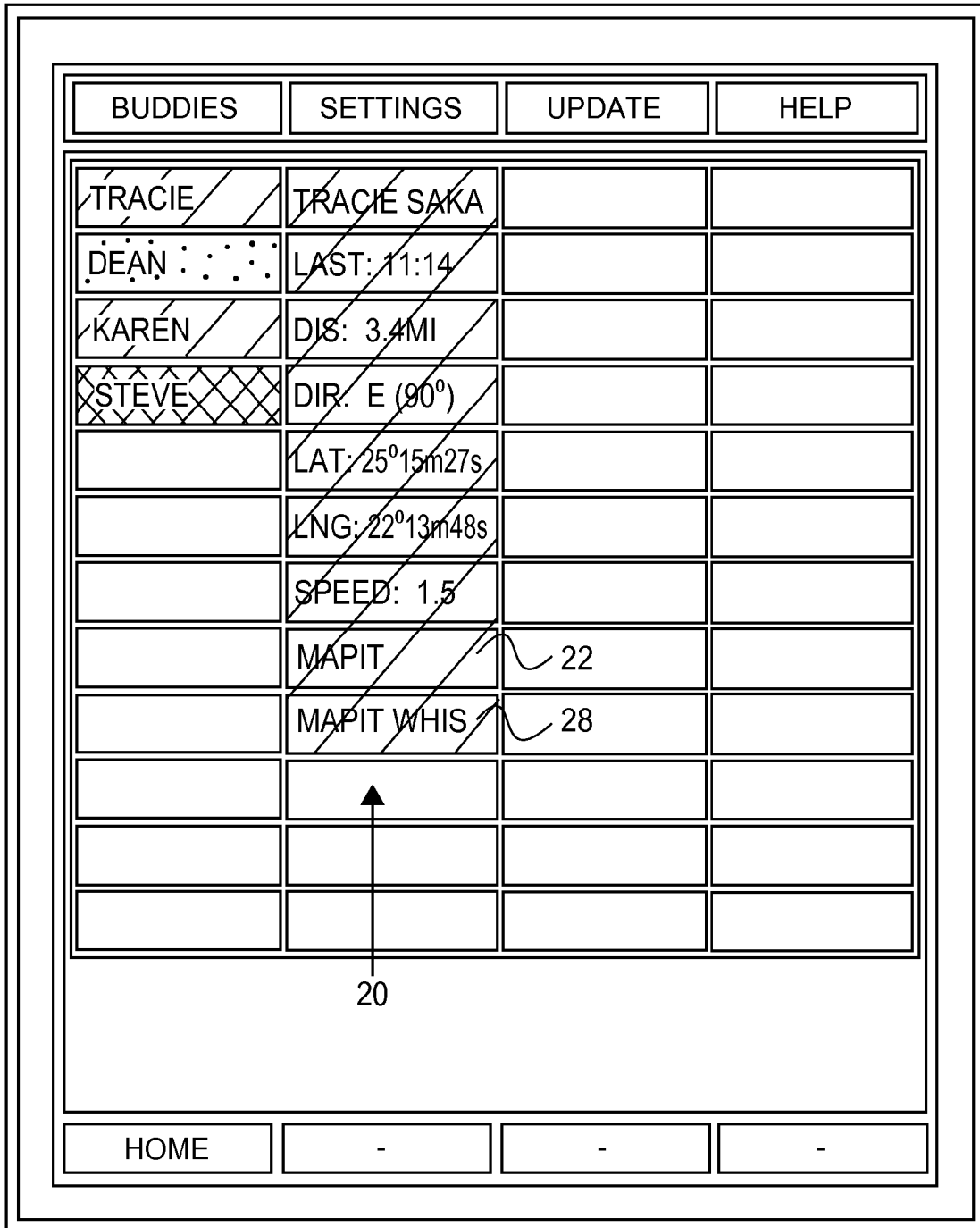

FIG. 2F



TYPICAL SCREEN SHOWING A NAMED BUDDY LIST'S CONTENTS

FIG. 3



TYPICAL SCREEN SHOWING A BUDDY'S LOCATION ETC.

FIG. 4

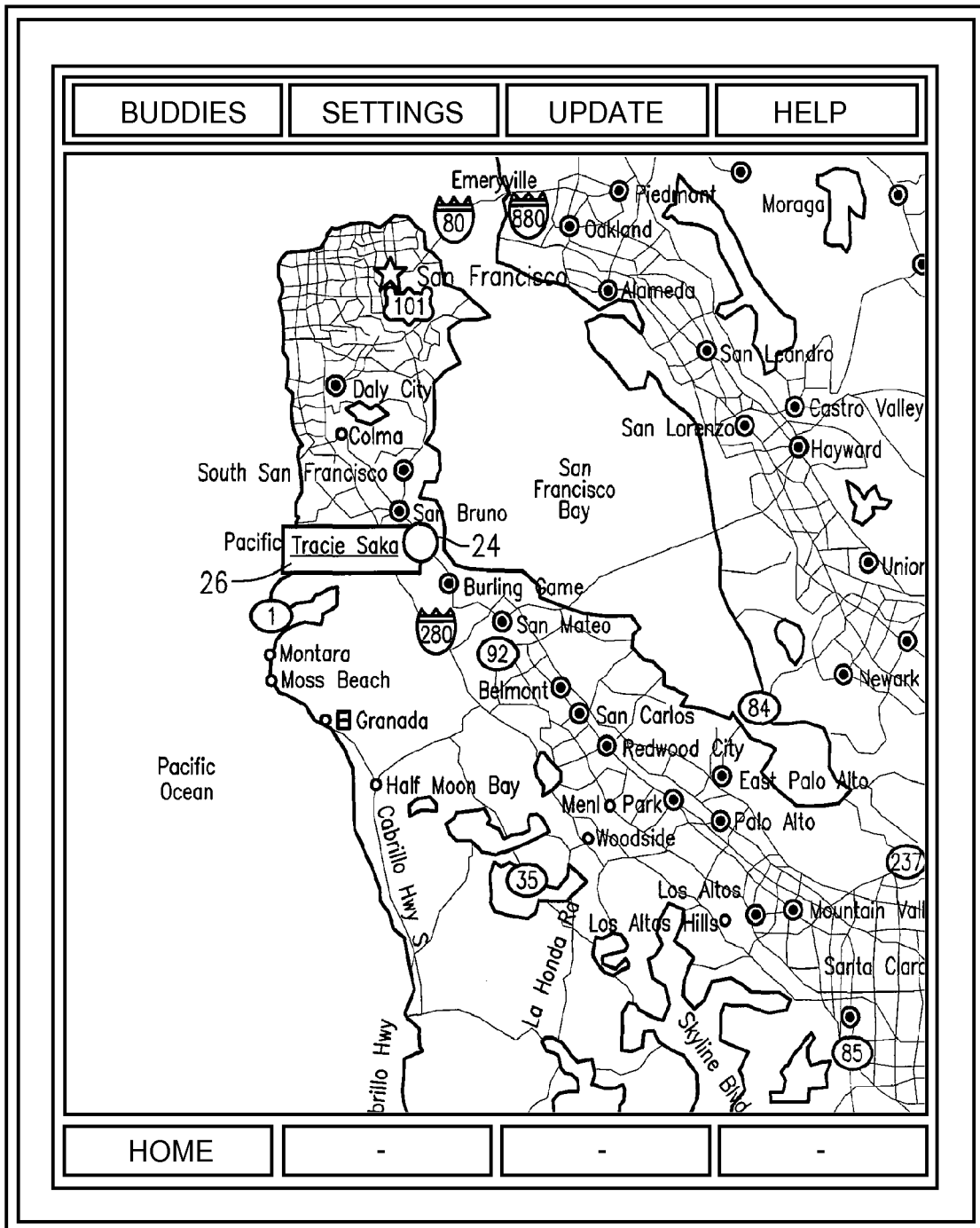

MAPIT™ DISPLAY

FIG. 5

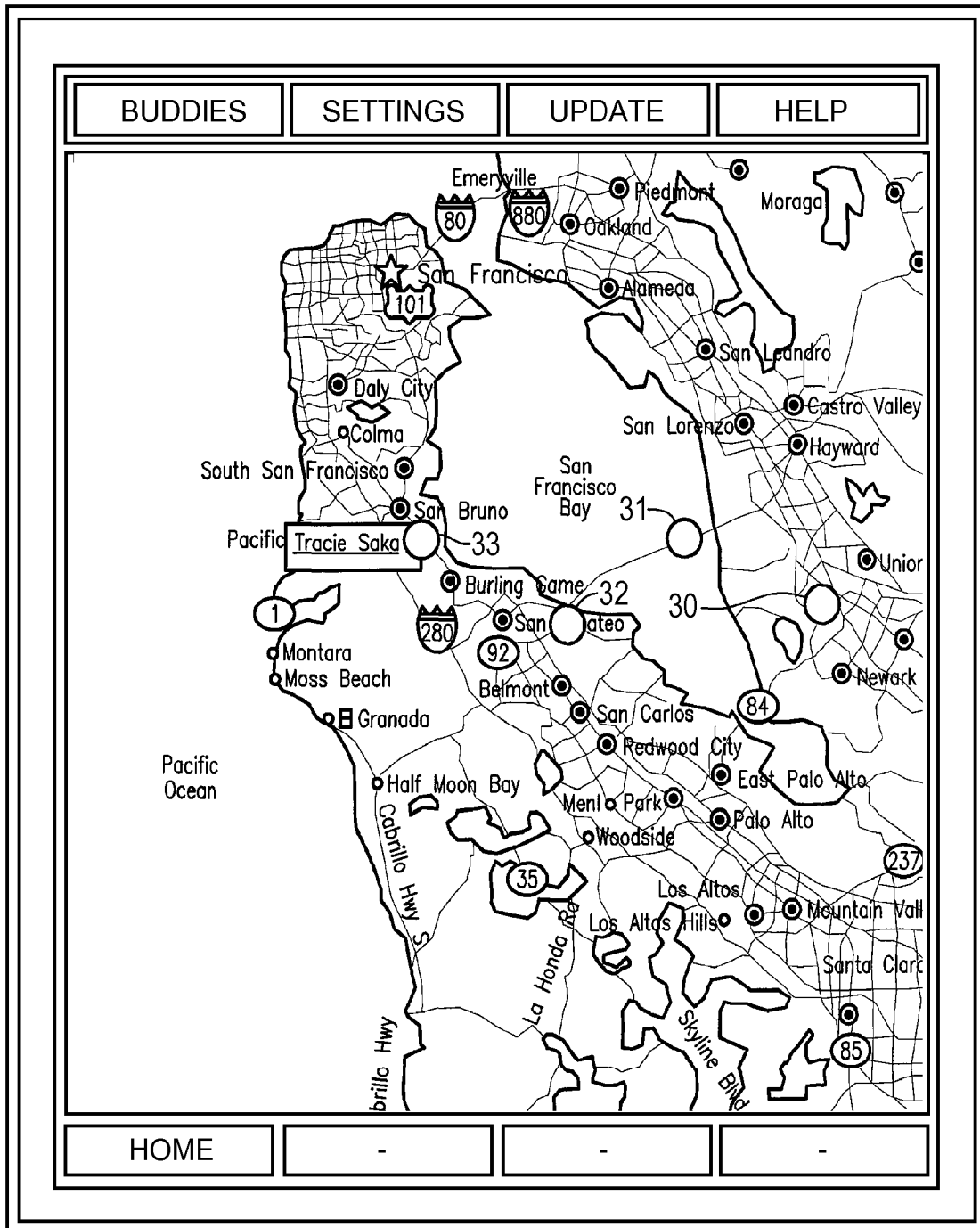

MAPIT DISPLAY SHOWING POSITION HISTORY OF A BUDDY

FIG. 6

BUDDIES	SETTINGS	UPDATE	HELP
TRACIE			
DEAN	DEAN SMITH	— 36	
KAREN	LAST: 11:14	— 34	
STEVE	DIS: 3.4MI	— 38	
	DIR: E (90°)	— 40	
	LAT: 25°15m27s	— 42	
	LNG: 22°13m48s	— 44	
	SPEED: 1.5	— 46	
	MAPIT	— 48	
	MAPIT W HIS		
HOME	-	-	-

TYPICAL SCREEN SHOWING POSITION AND STATUS OF A MEMBER OF A GROUP

FIG. 7

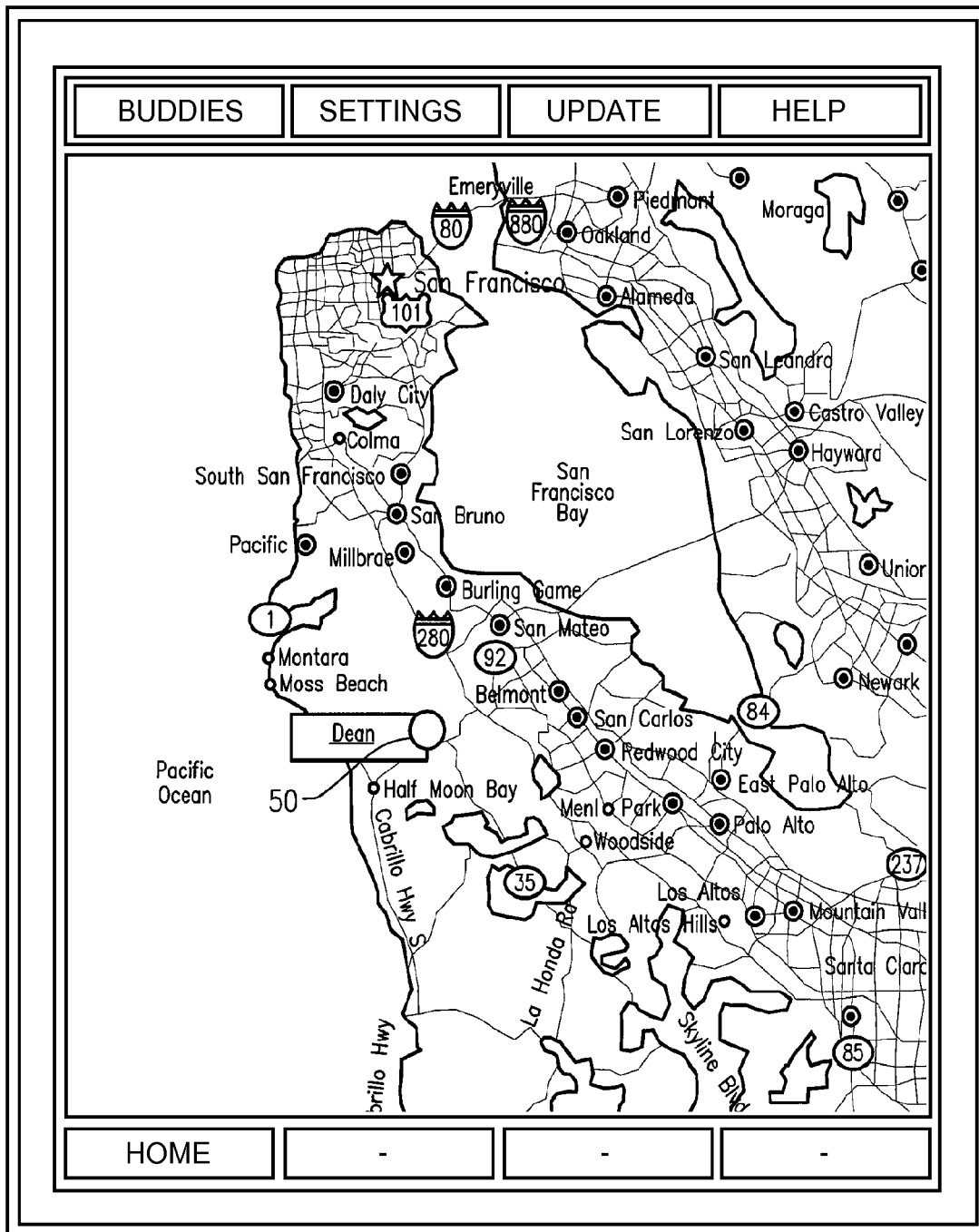

MAPIT DISPLAY WHEN THE POSITION OF A BUDDY IS REQUESTED

FIG. 8

BUDDIES	SETTINGS	UPDATE	HELP
TENNIS TEAM			
SKI			
AUSTIN			
JOSE			
KIRSTEN			
PAUL			
12313134Kdx1	INST01	52	
	LAST: 10:47	54	
	DIS: 4.7MI	56	
	DIR: NE (45°)	58	
	LAT: 25°15m27s	60	
	LNG: 22°13m48s	62	
	SPEED: NONE	64	
	MAPIT	66	
	MAPIT W HIS	68	
HOME	-	-	-

SCREEN SHOT SHOWING AN INSTANT BUDDIES LOCATION

FIG. 9

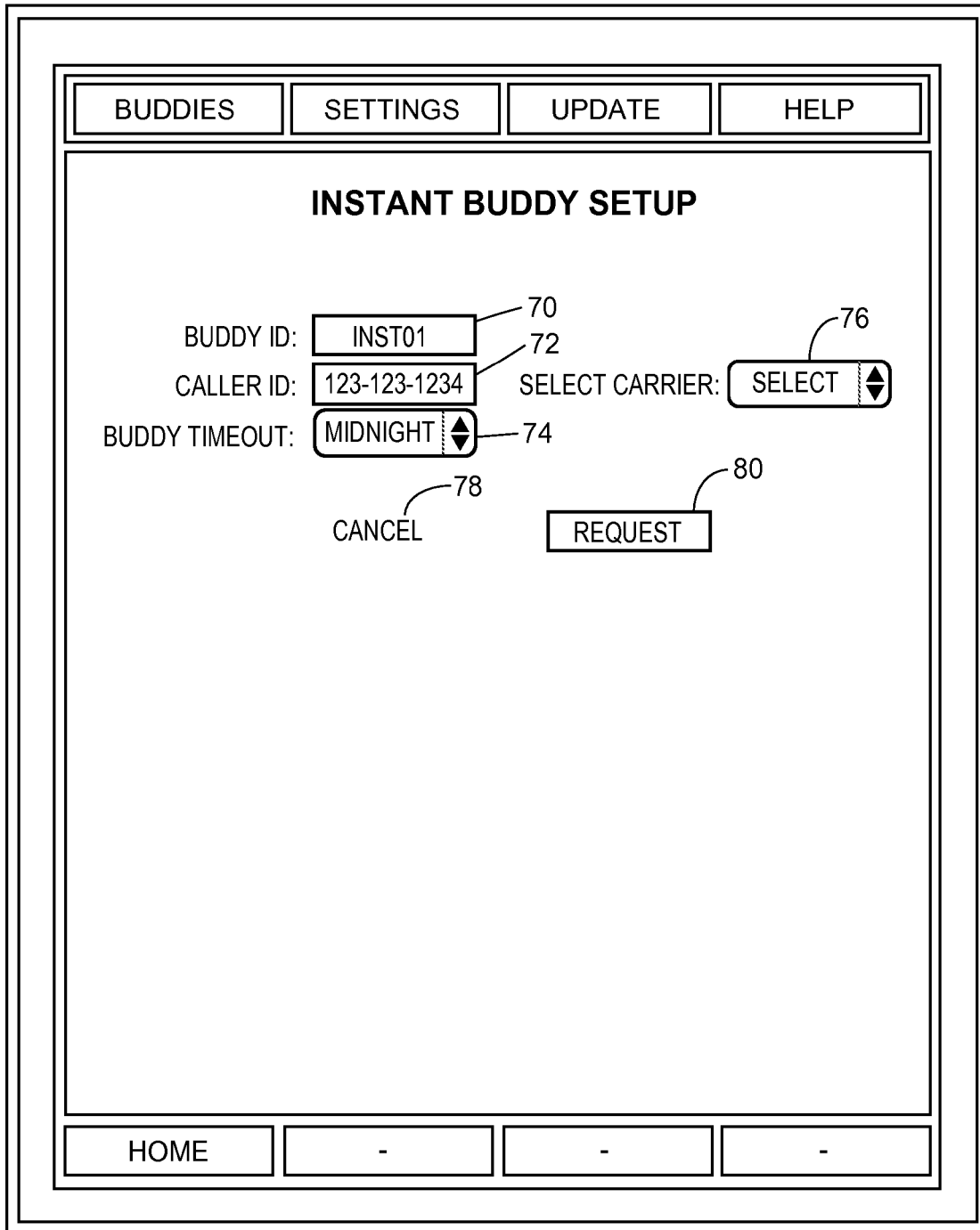

INSTANT BUDDY SETUP SCREEN

FIG. 10

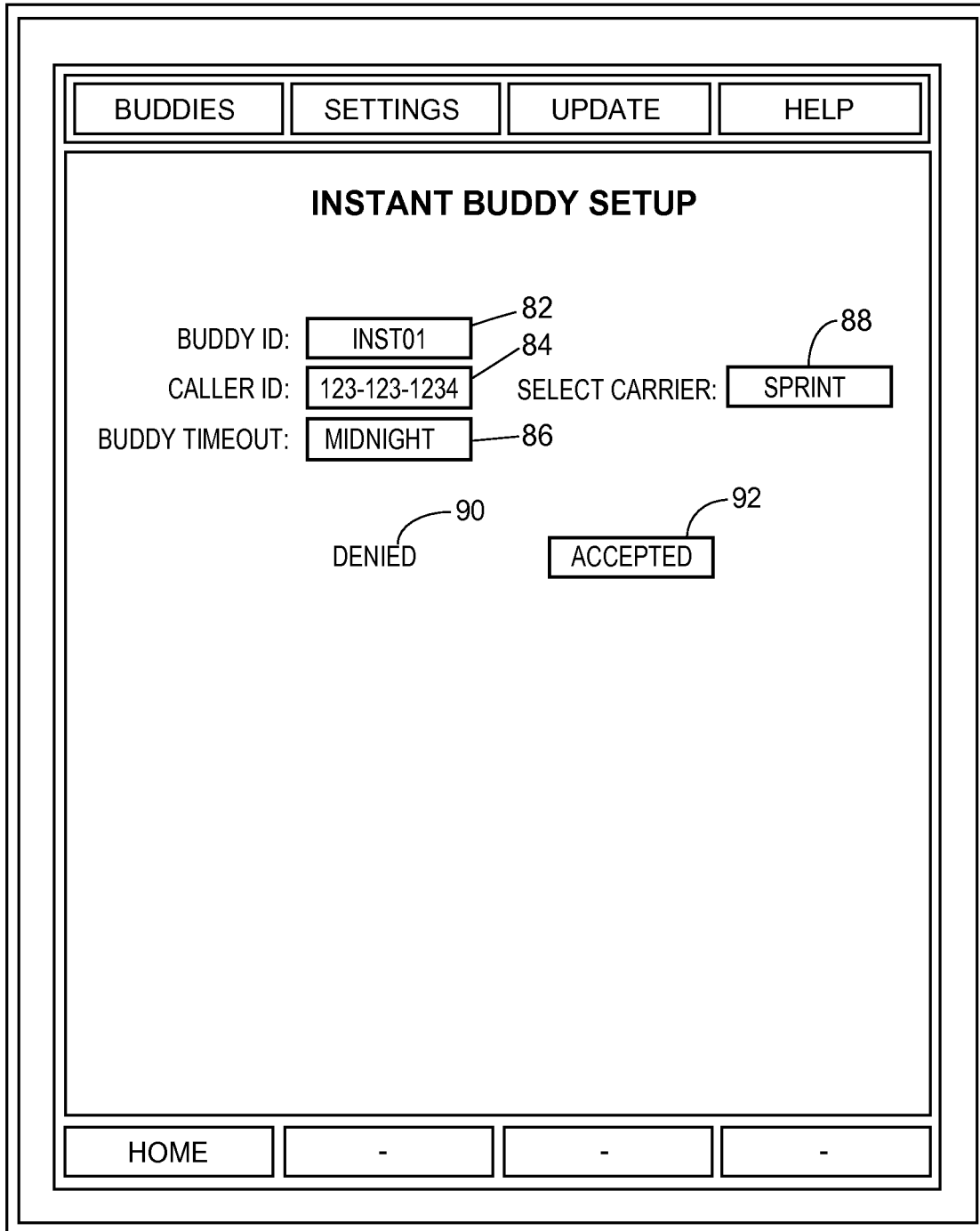

INSTANT BUDDY SETUP SCREEN DISPLAYED ON PHONE OF INSTANT BUDDY

FIG. 11

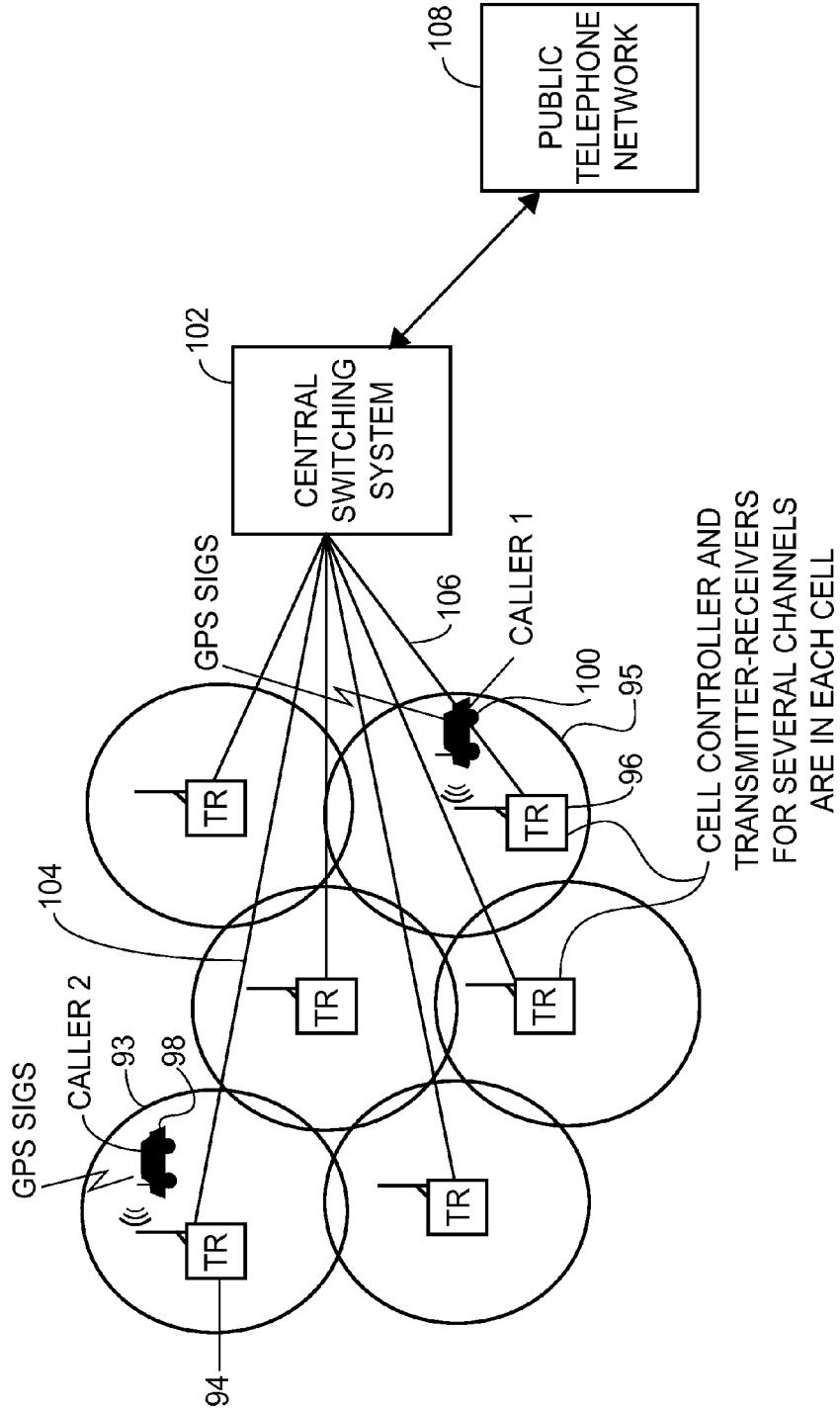

PRIOR ART CELL PHONE SYSTEM
PEER TO PEER EMBODIMENT

FIG. 12

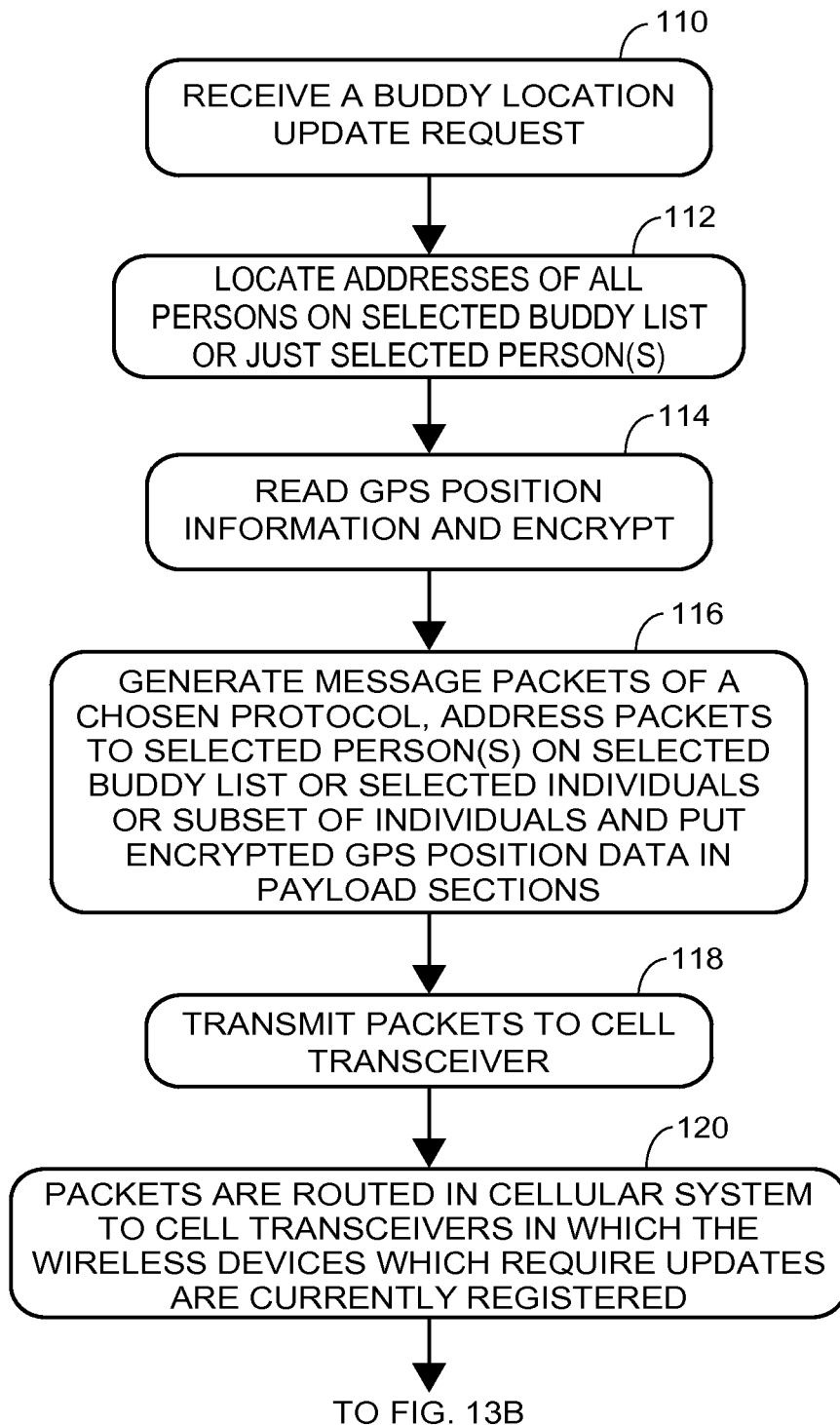

BUDDY WATCH SERVER & CELL PHONE PROCESS TO EXCHANGE POSITION DATA

FIG. 13A

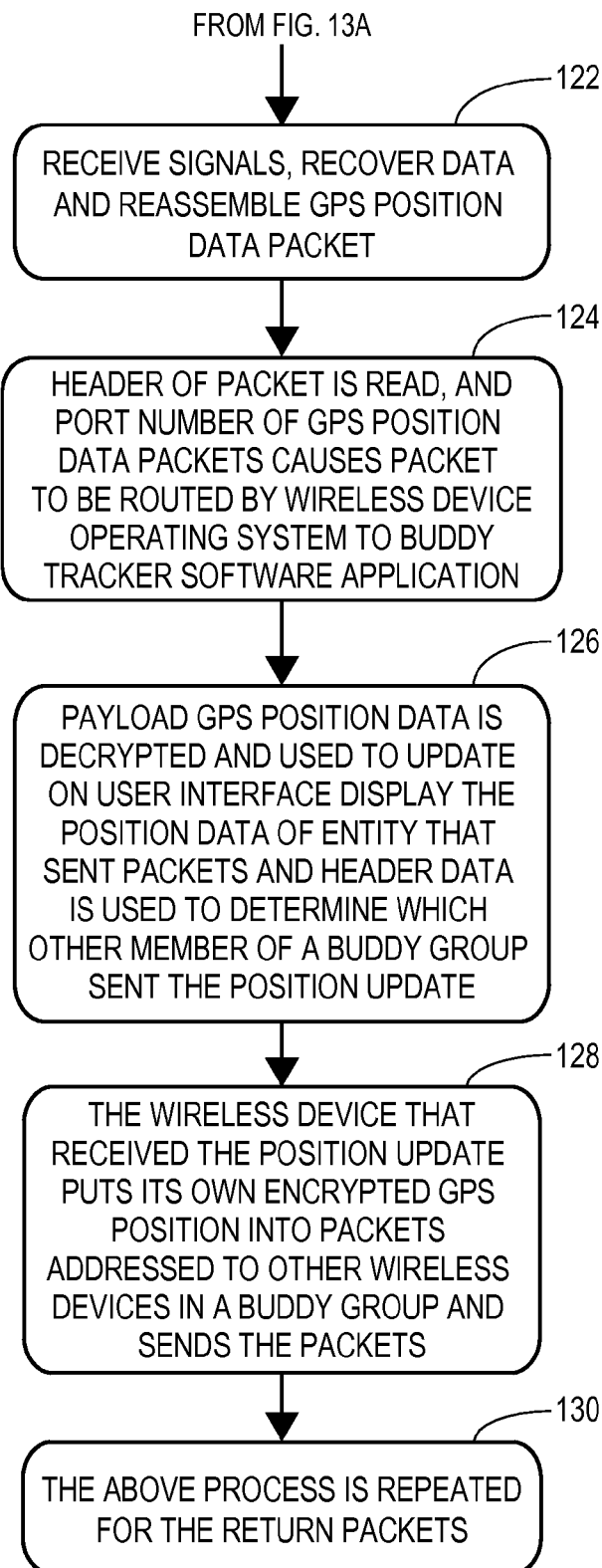
**FIG. 13B**

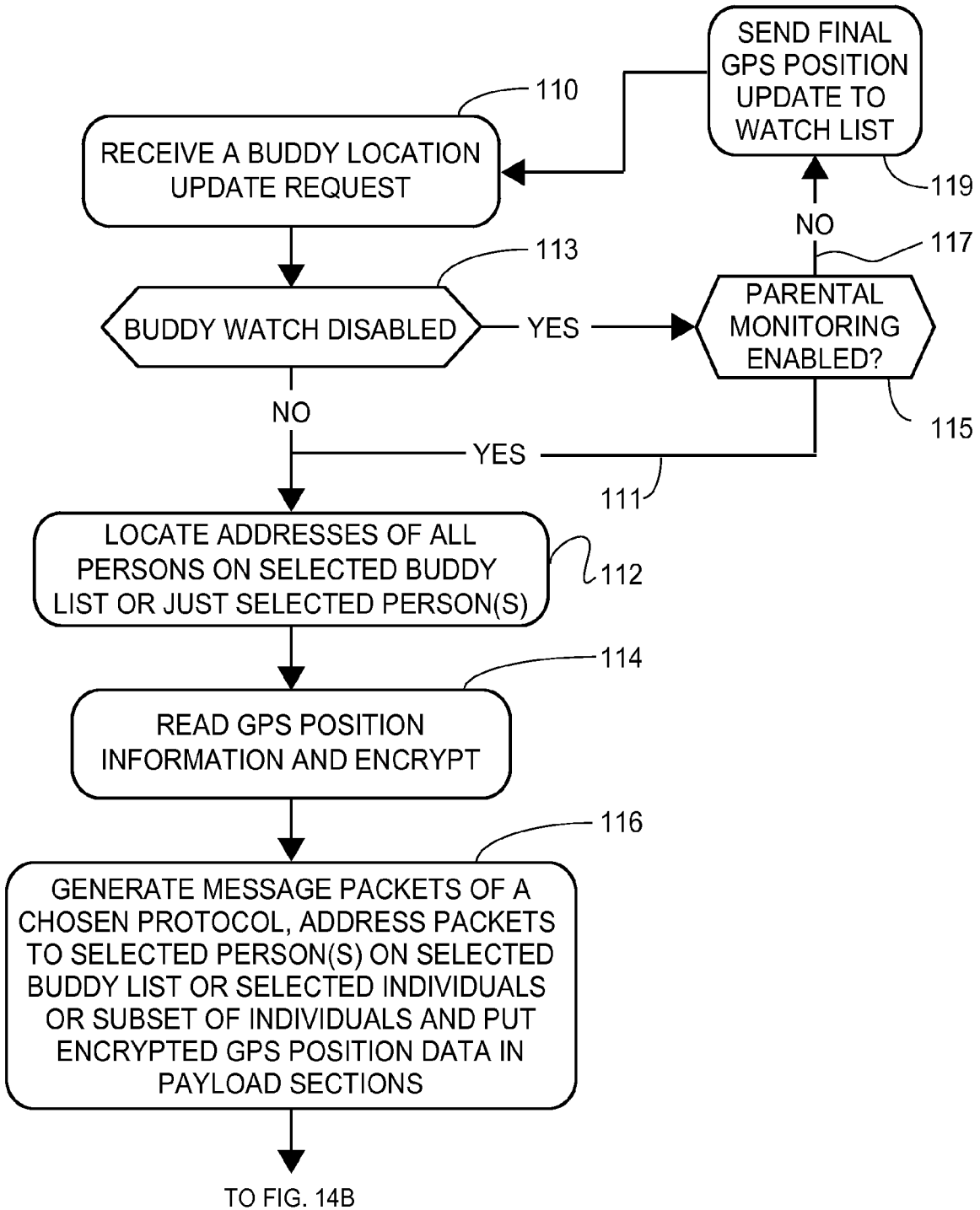

ALT. EMB. OF POSITION EXCHANGE PROCESS

FIG. 14A

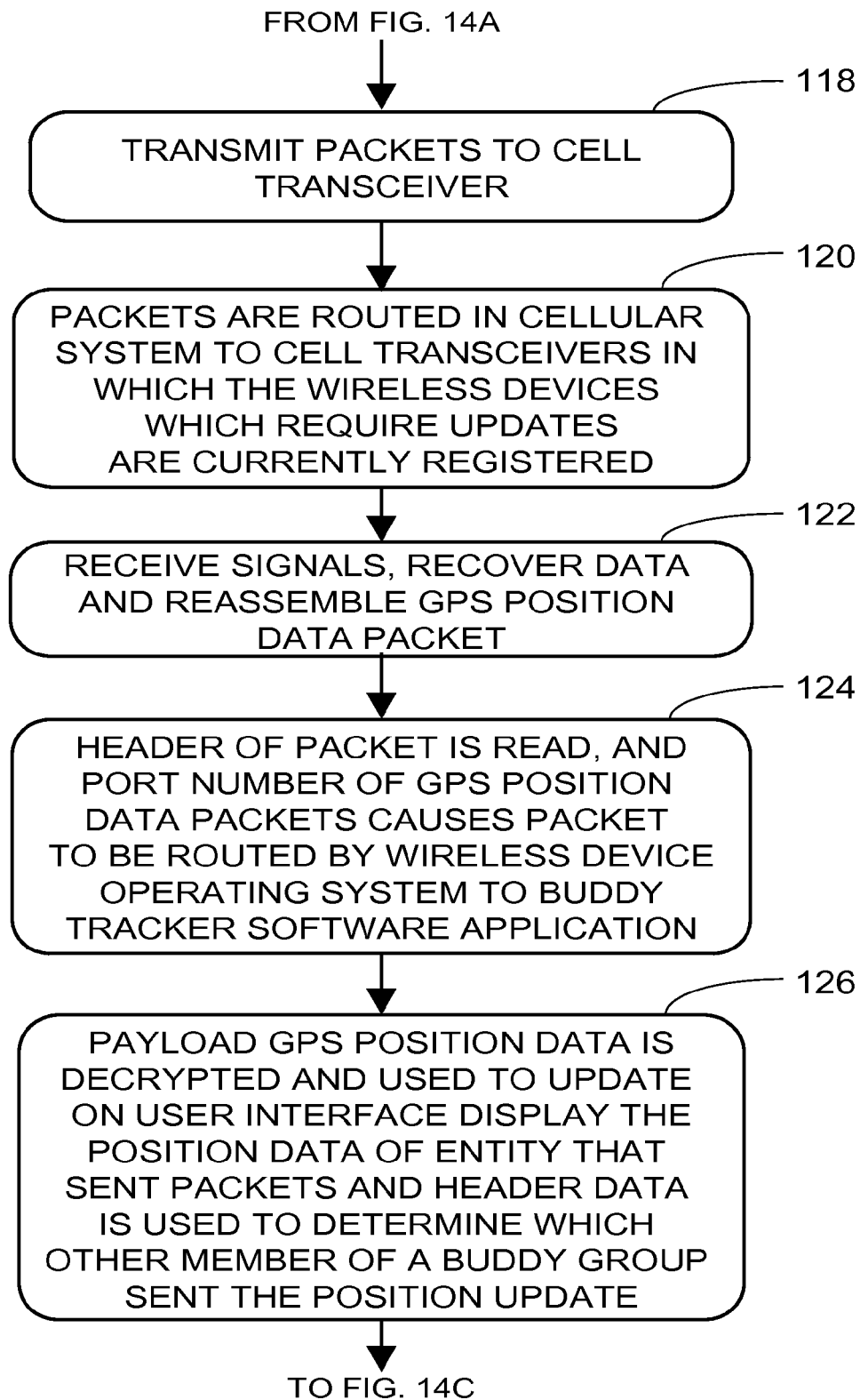
**FIG. 14B**

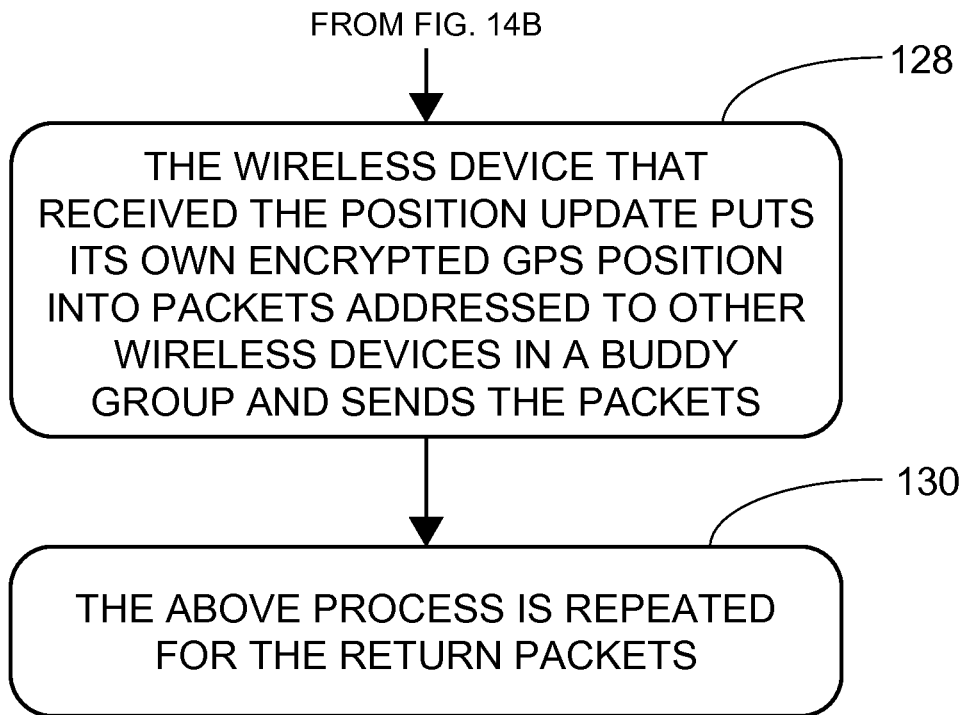

FIG. 14C

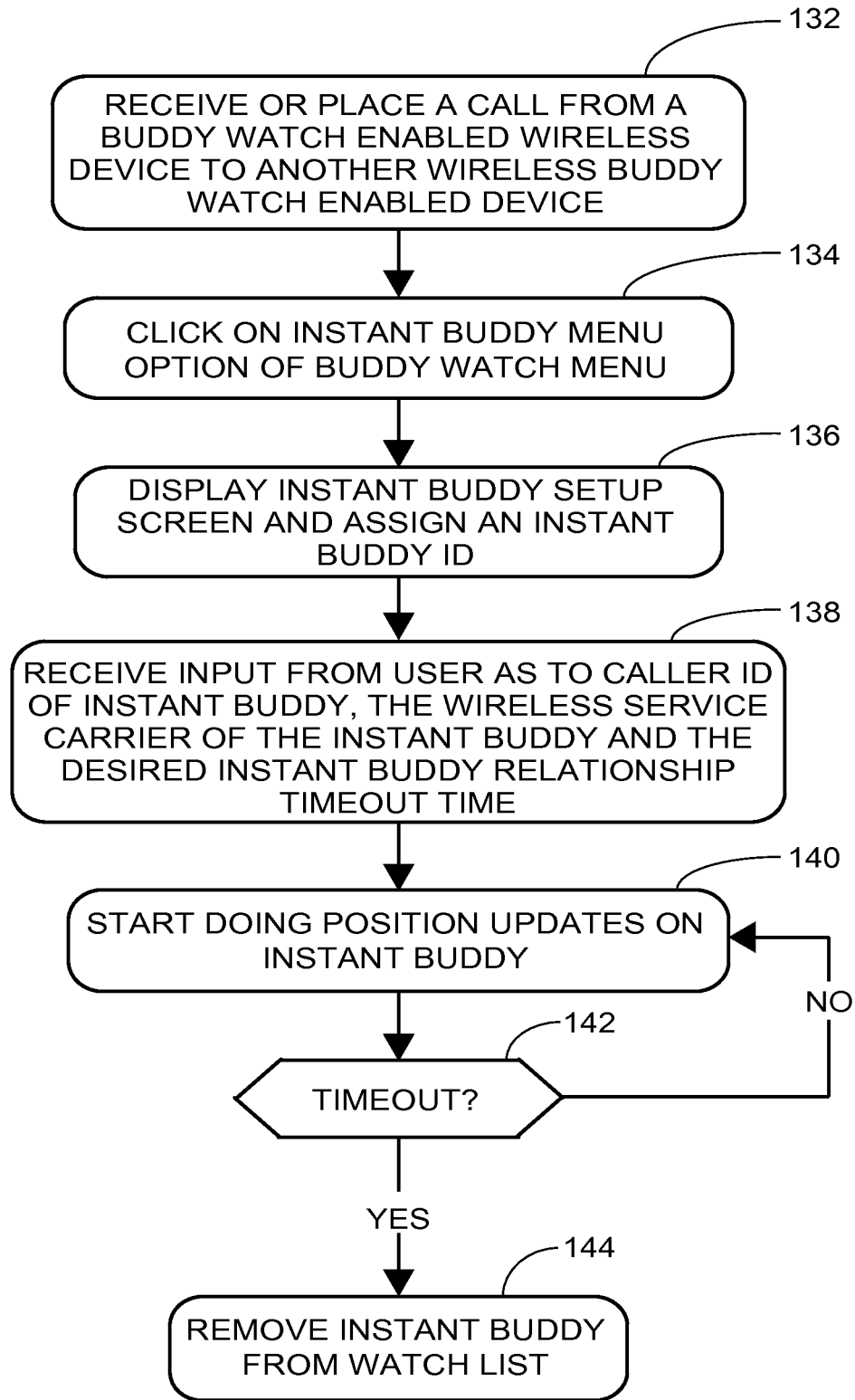

FIG. 15

PREFERRED INSTANT BUDDY SETUP PROCESS

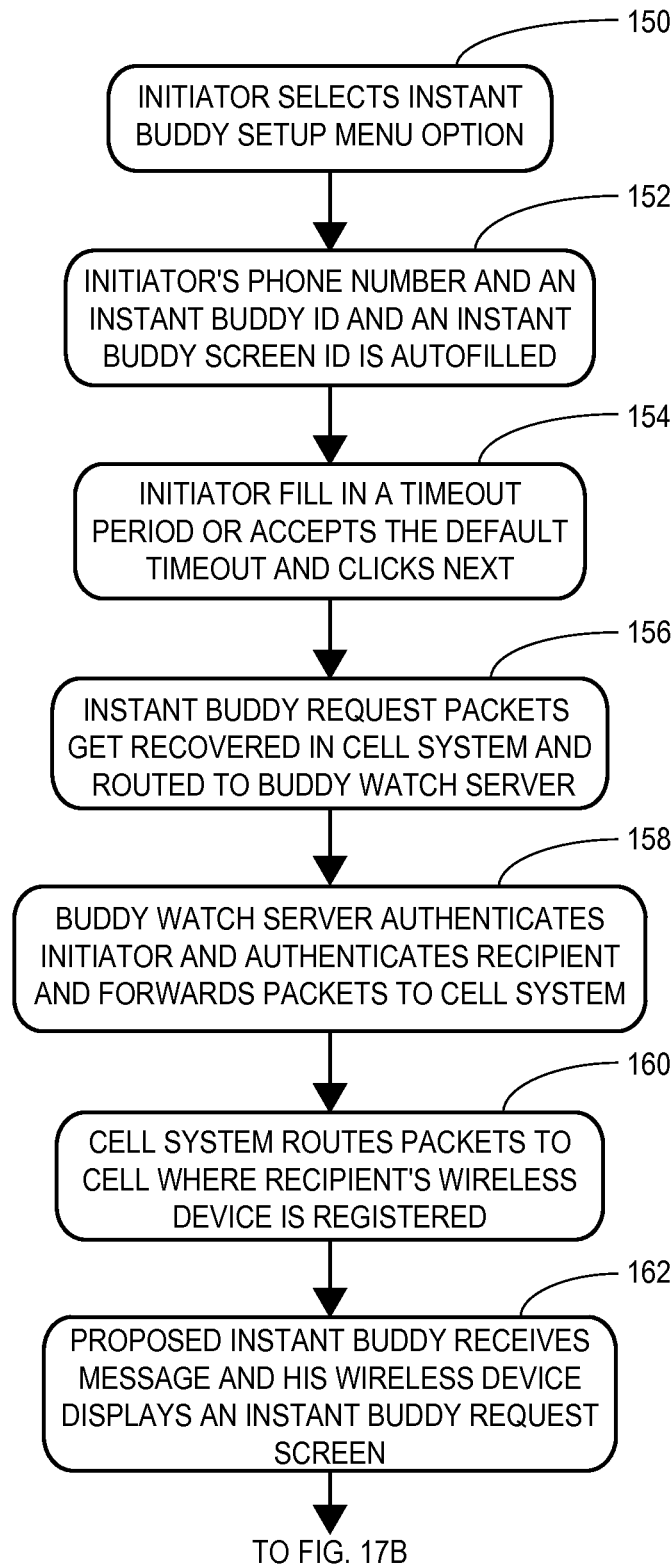

FIG. 17A

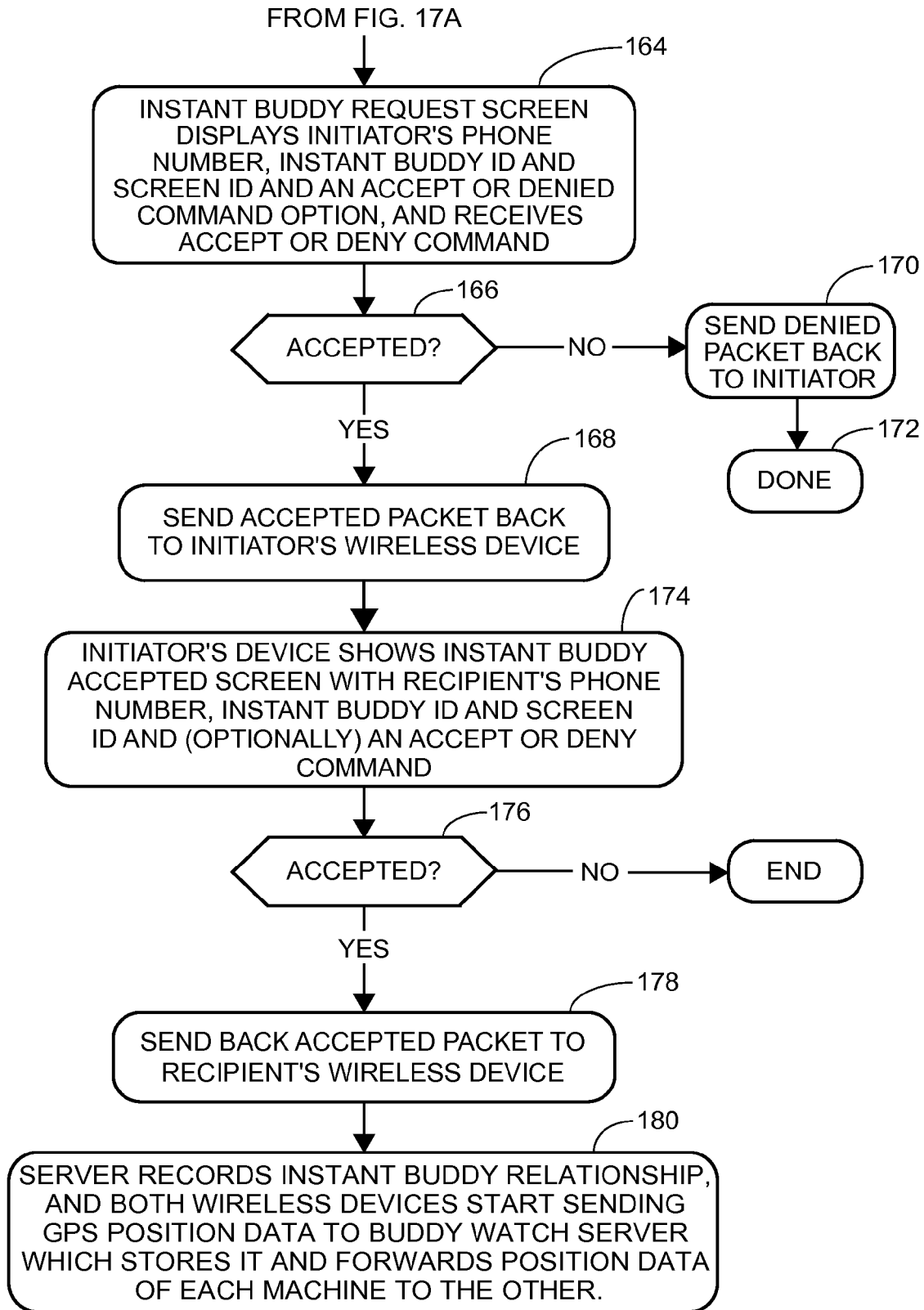

FIG. 17B

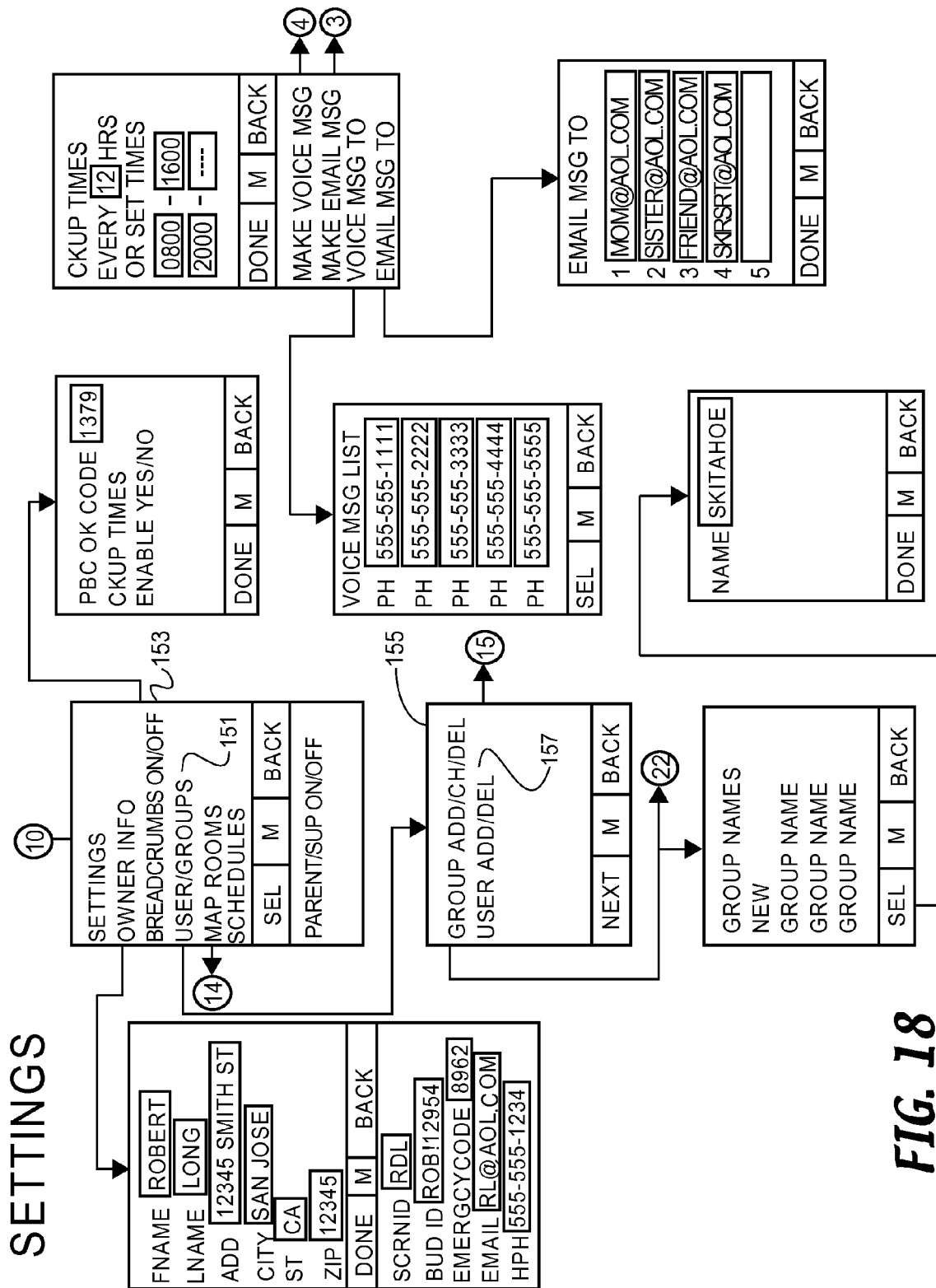

FIG. 18

CREATE AN INSTANT BUDDY

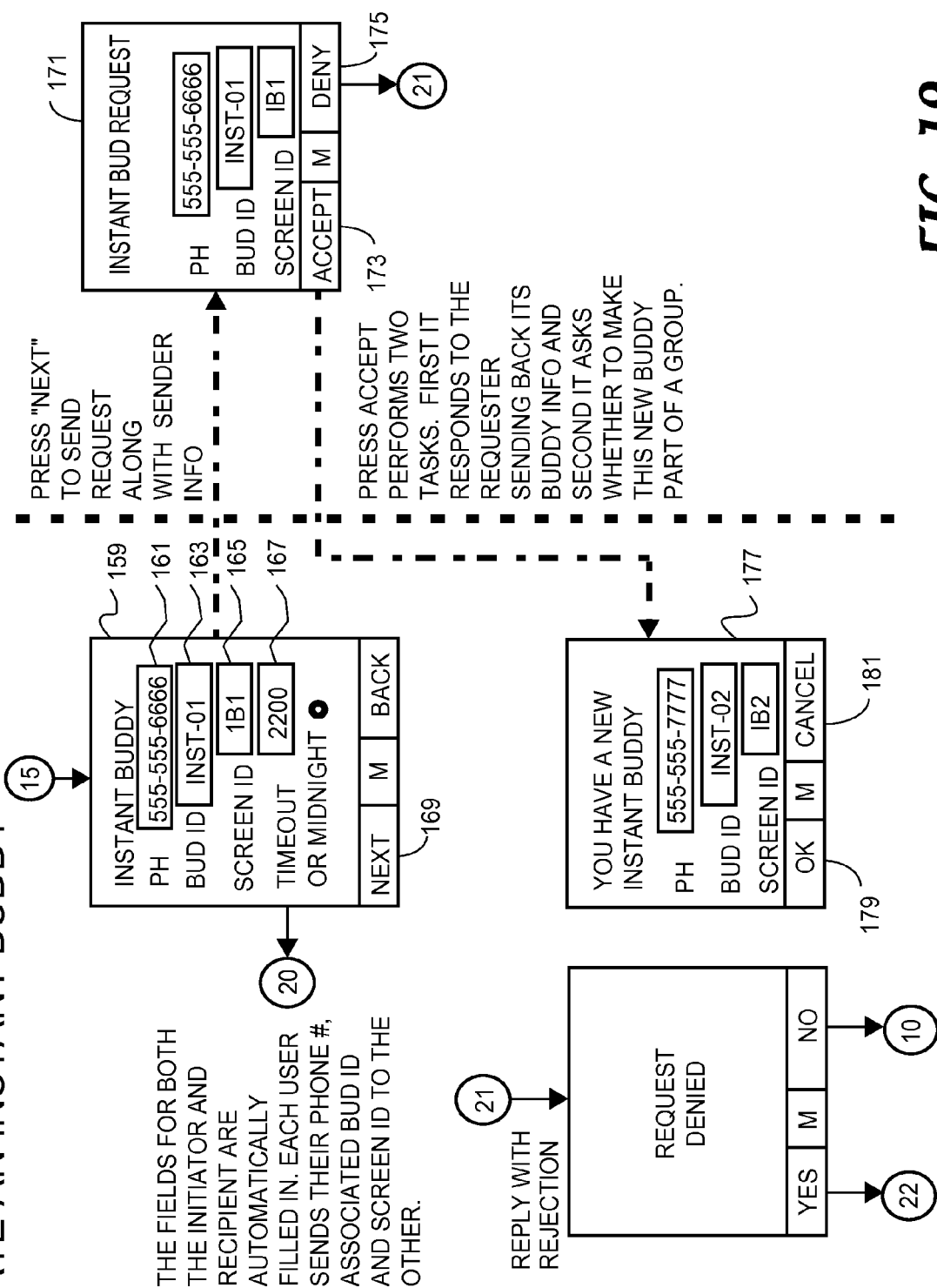

FIG. 19

PROCESS TO ESTABLISH AND USE PERSONAL BREAD CRUMBS MODE

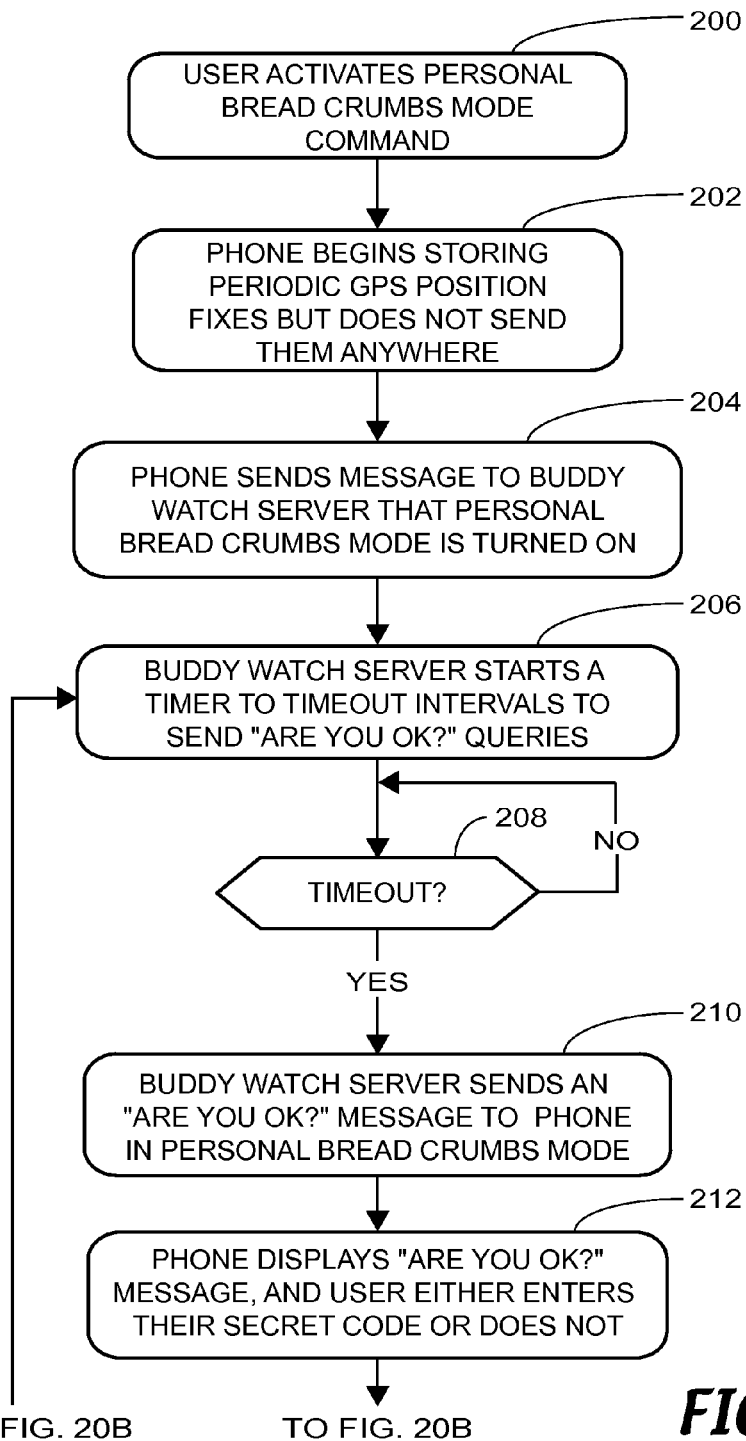

FIG. 20A

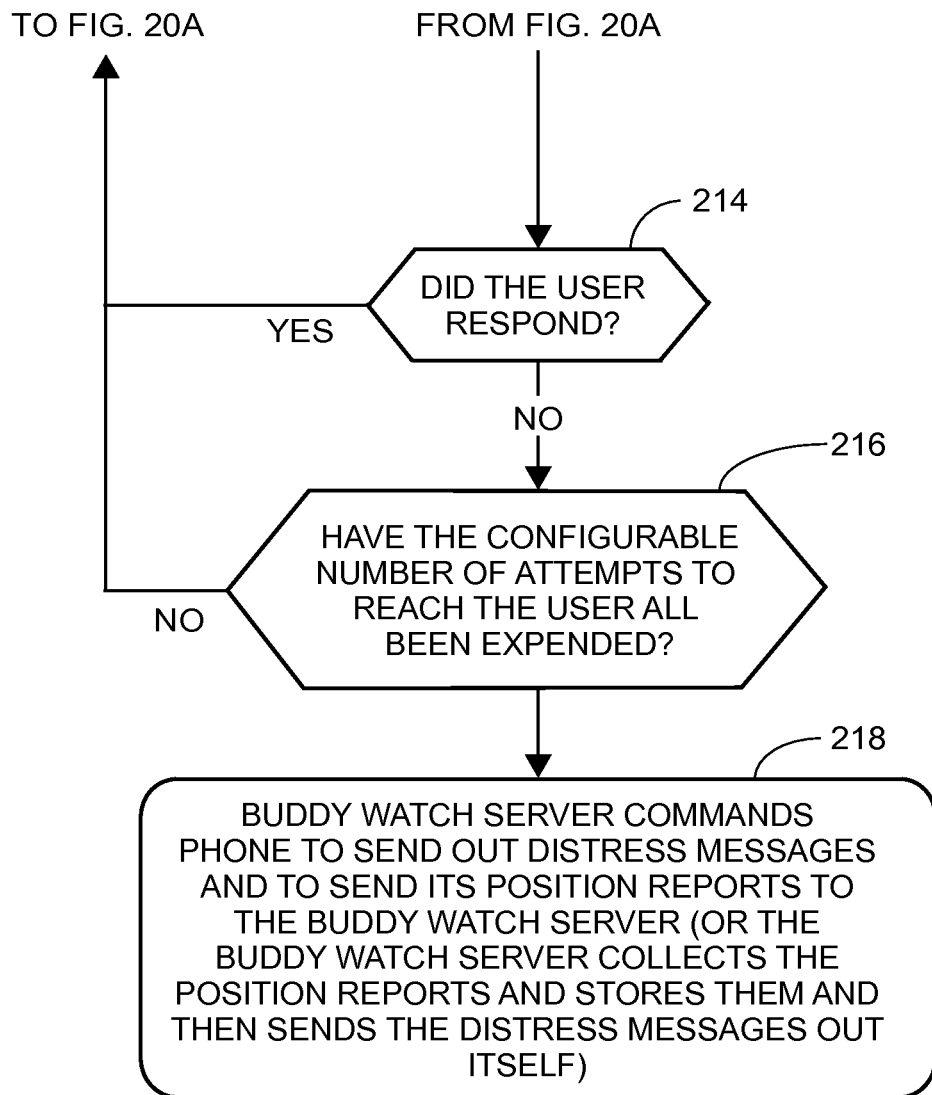

FIG. 20B

PROCESS TO ESTABLISH AND USE PERSONAL BREAD CRUMBS MODE

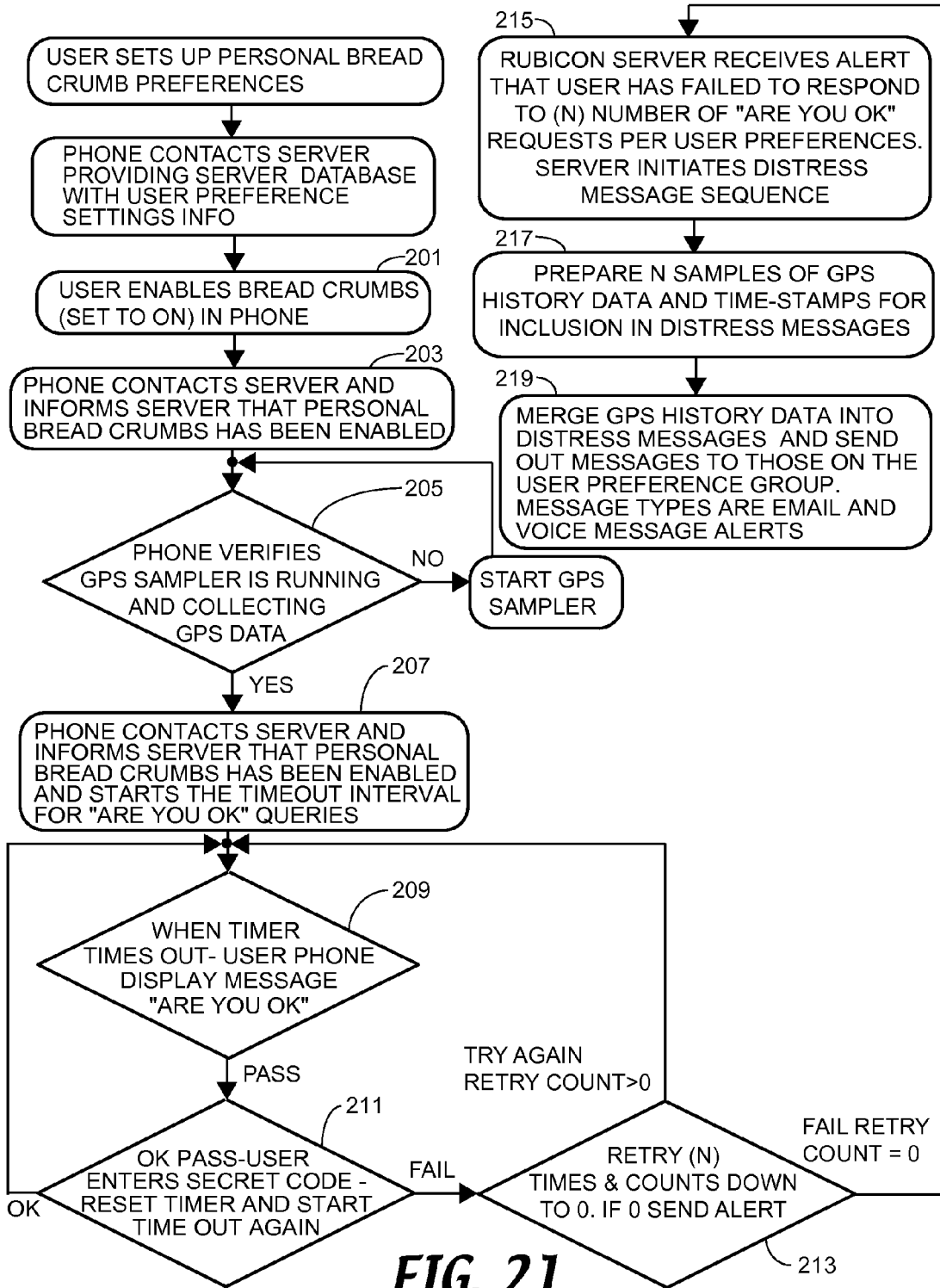
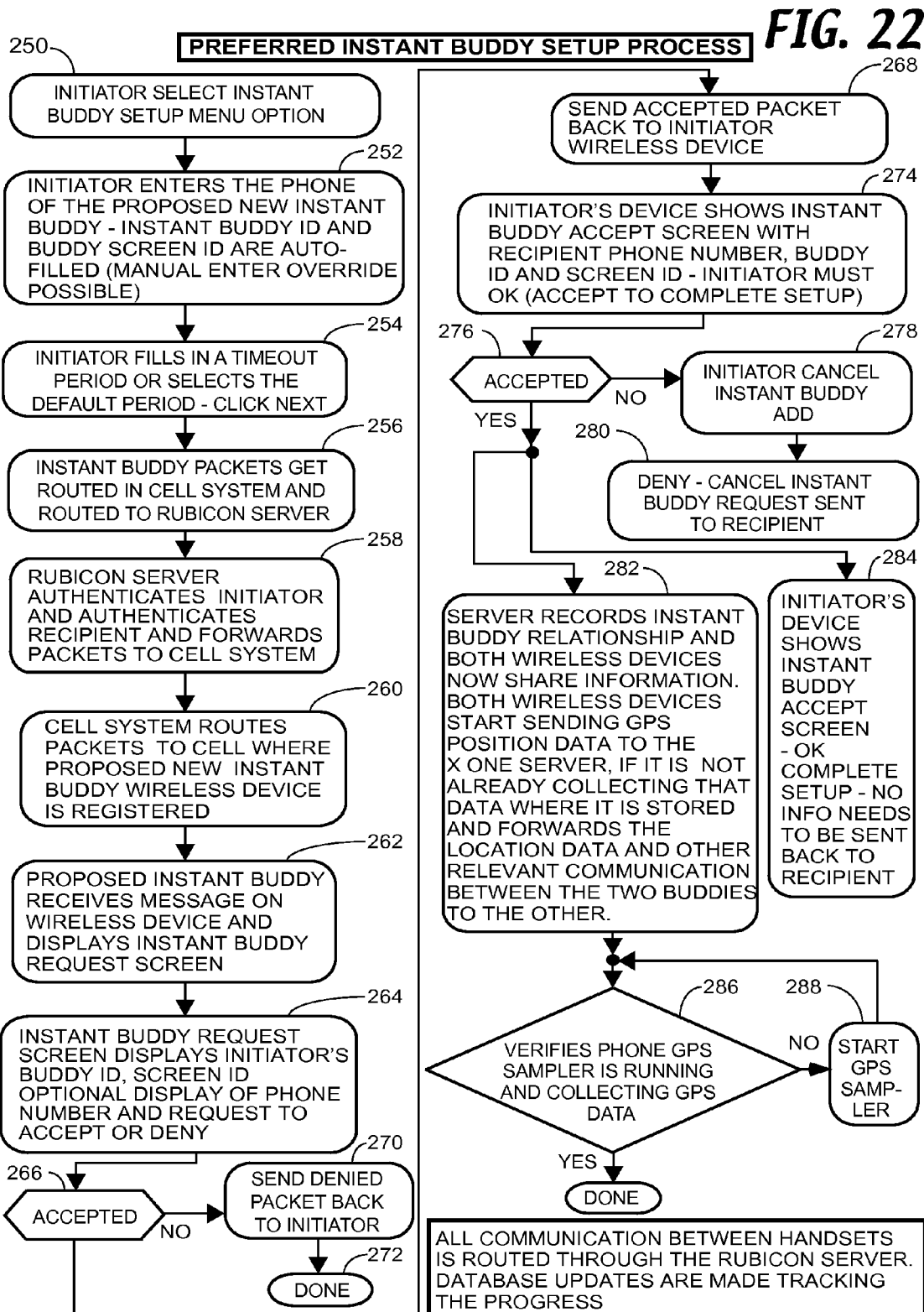
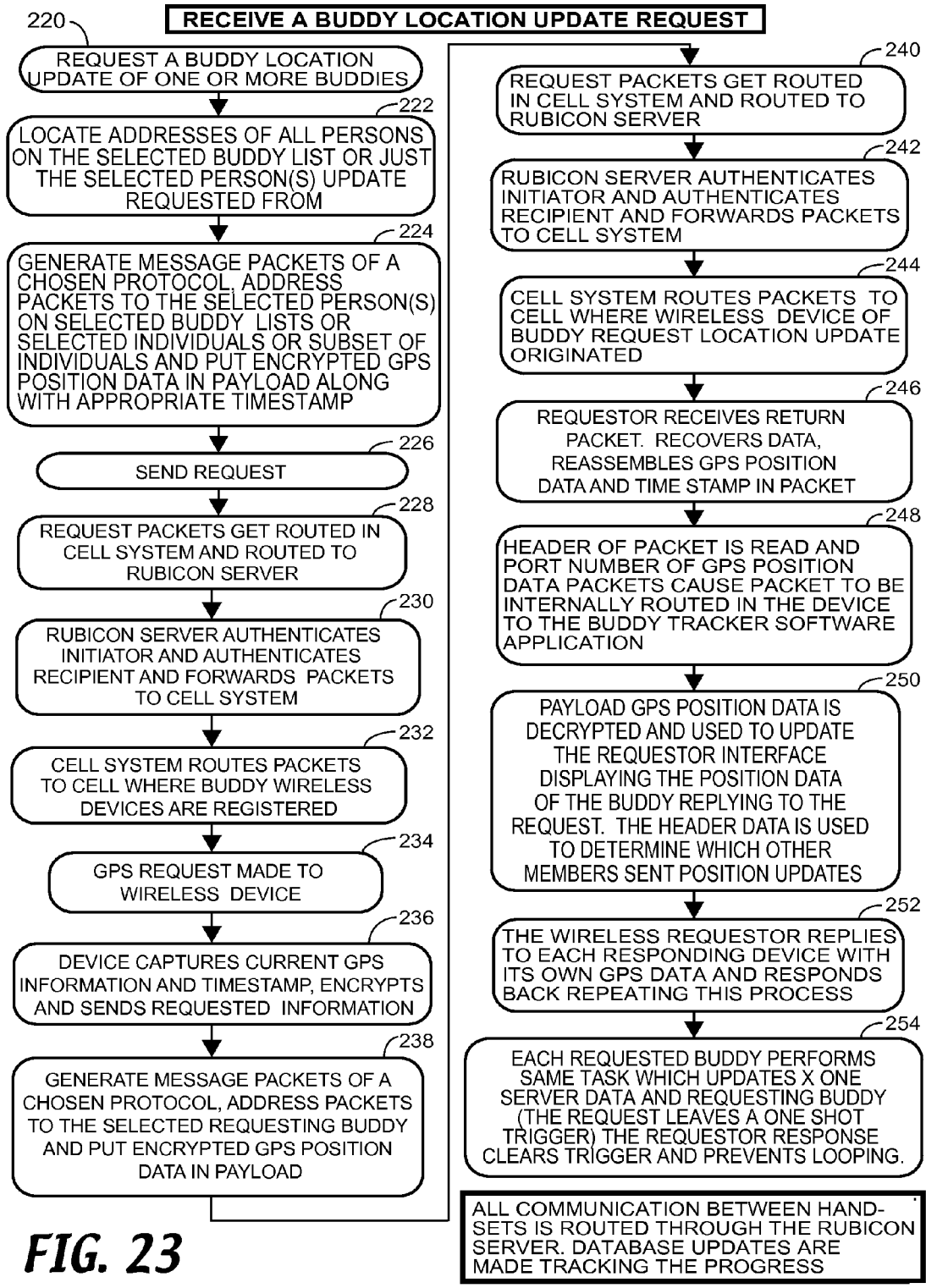

FIG. 21





DEFAULT START SCREEN

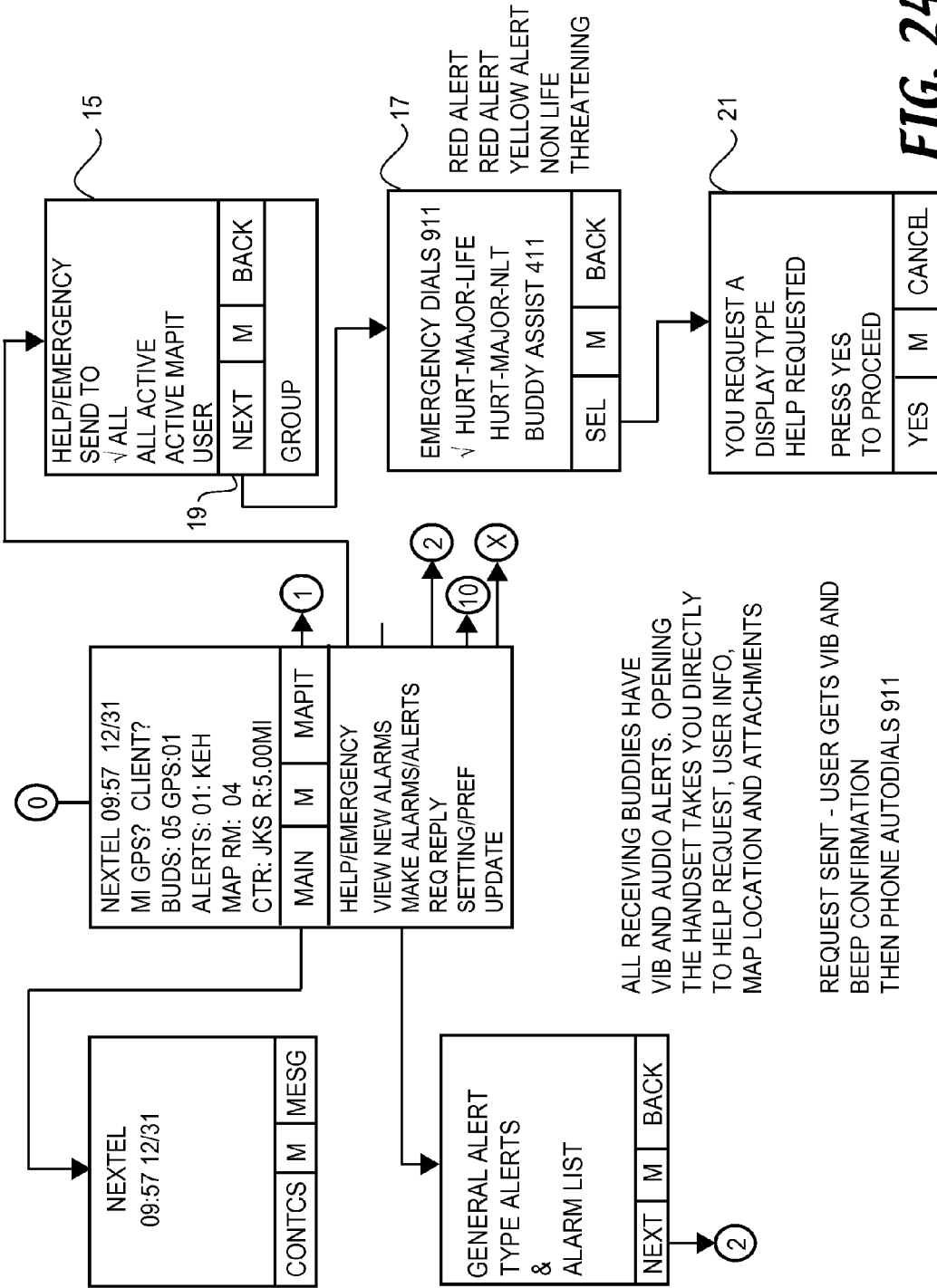

FIG. 24

HELP

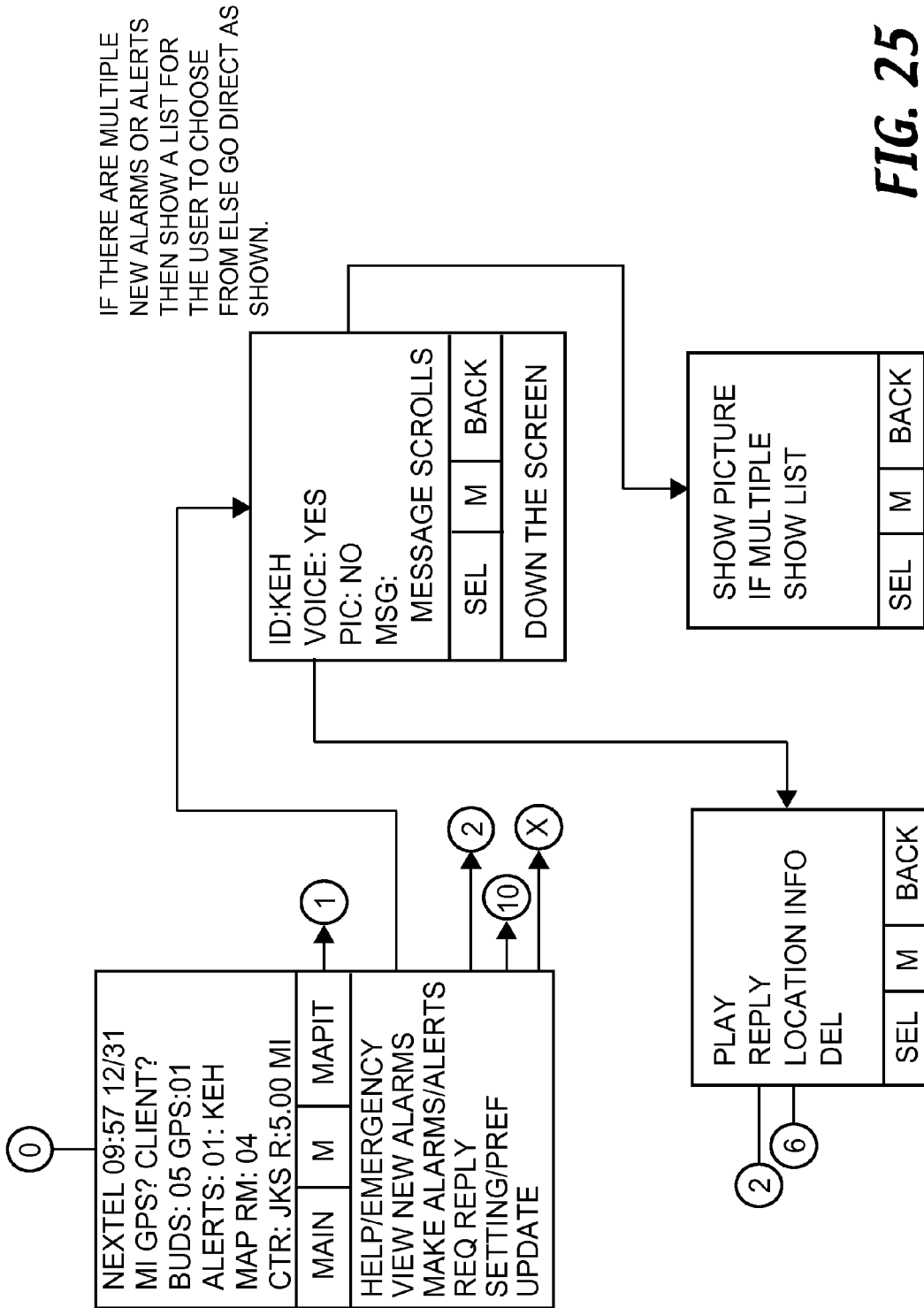

FIG. 25

MAPIT

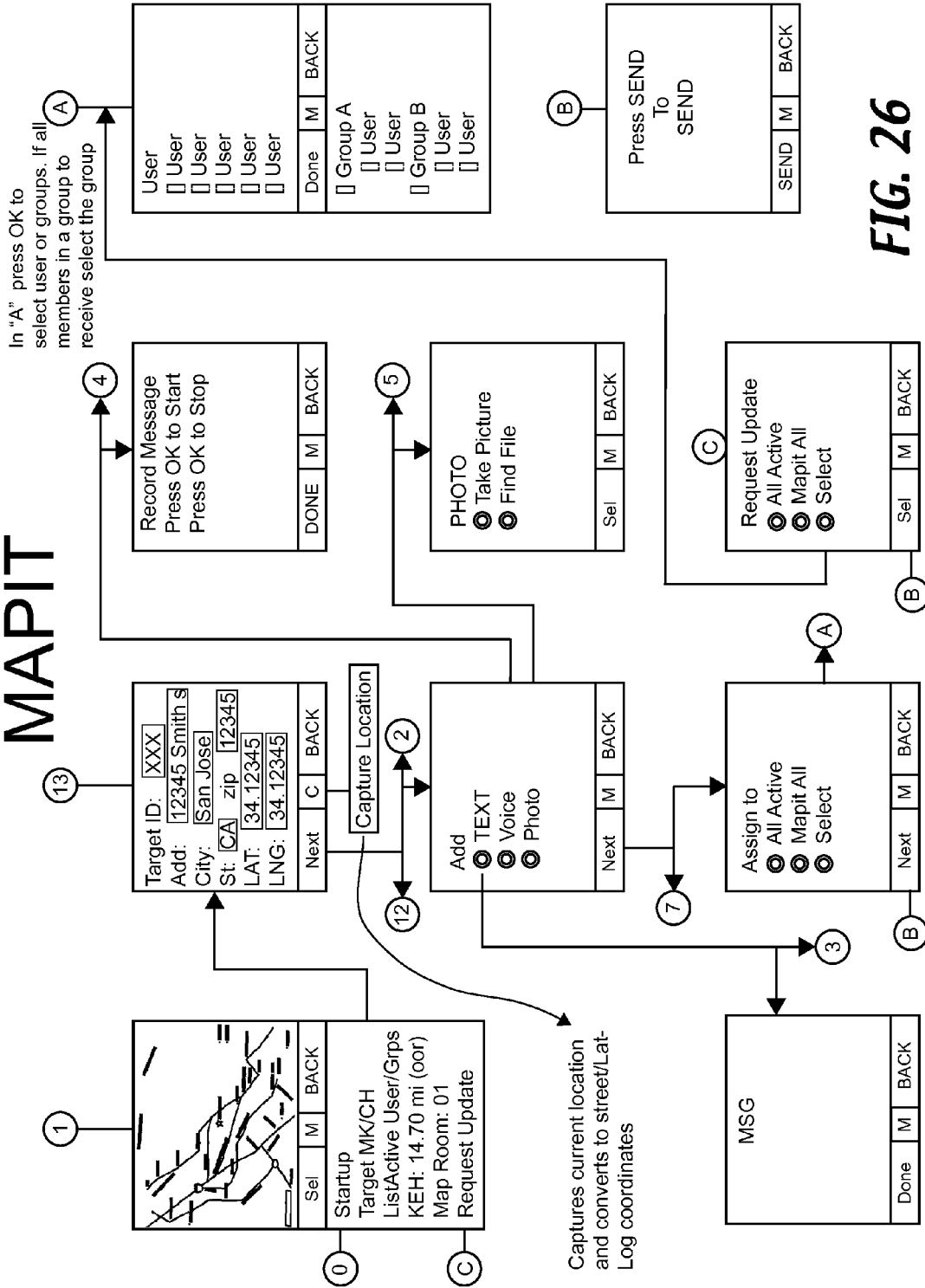

FIG. 26

RECENTER ON USER

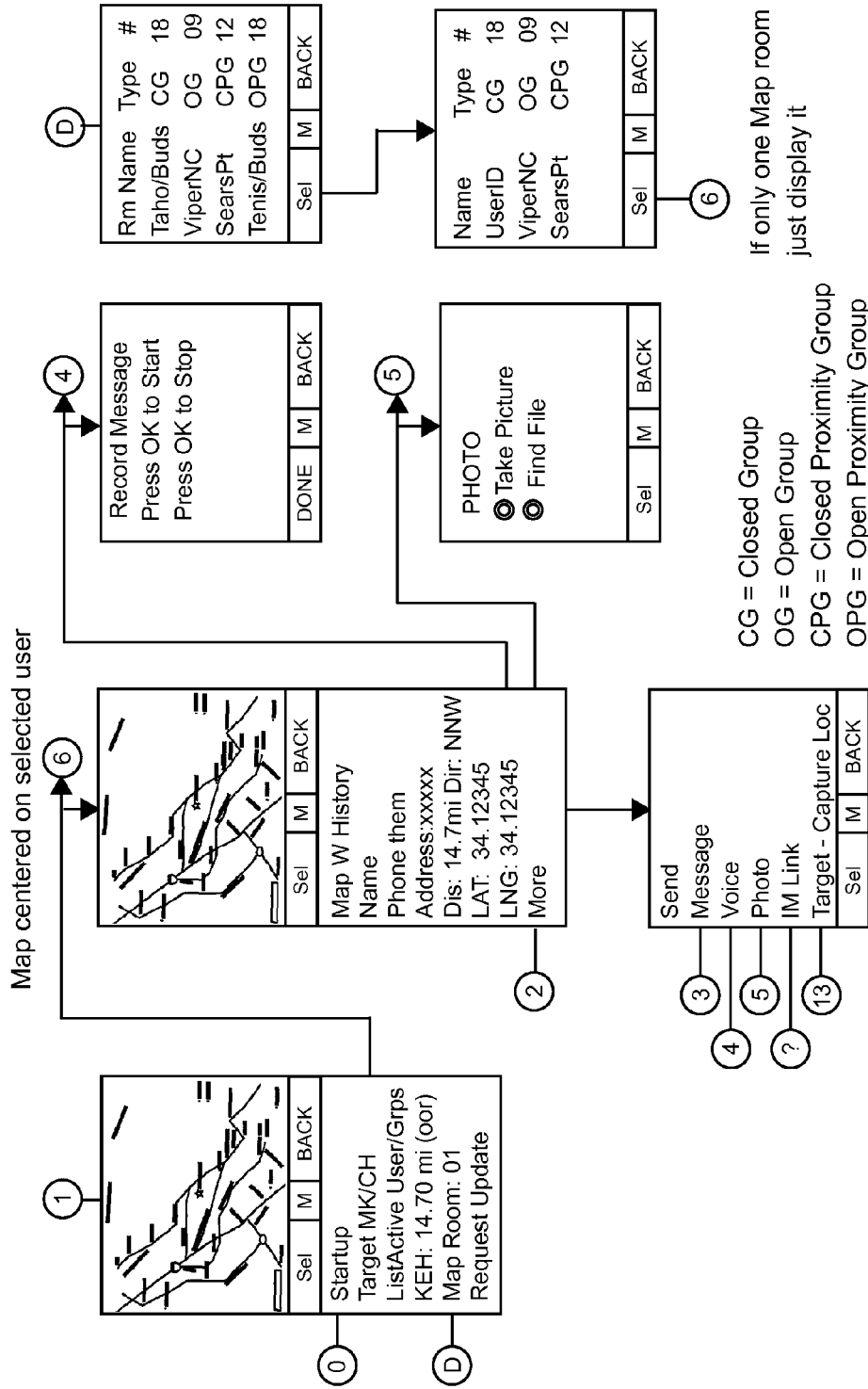

FIG. 27

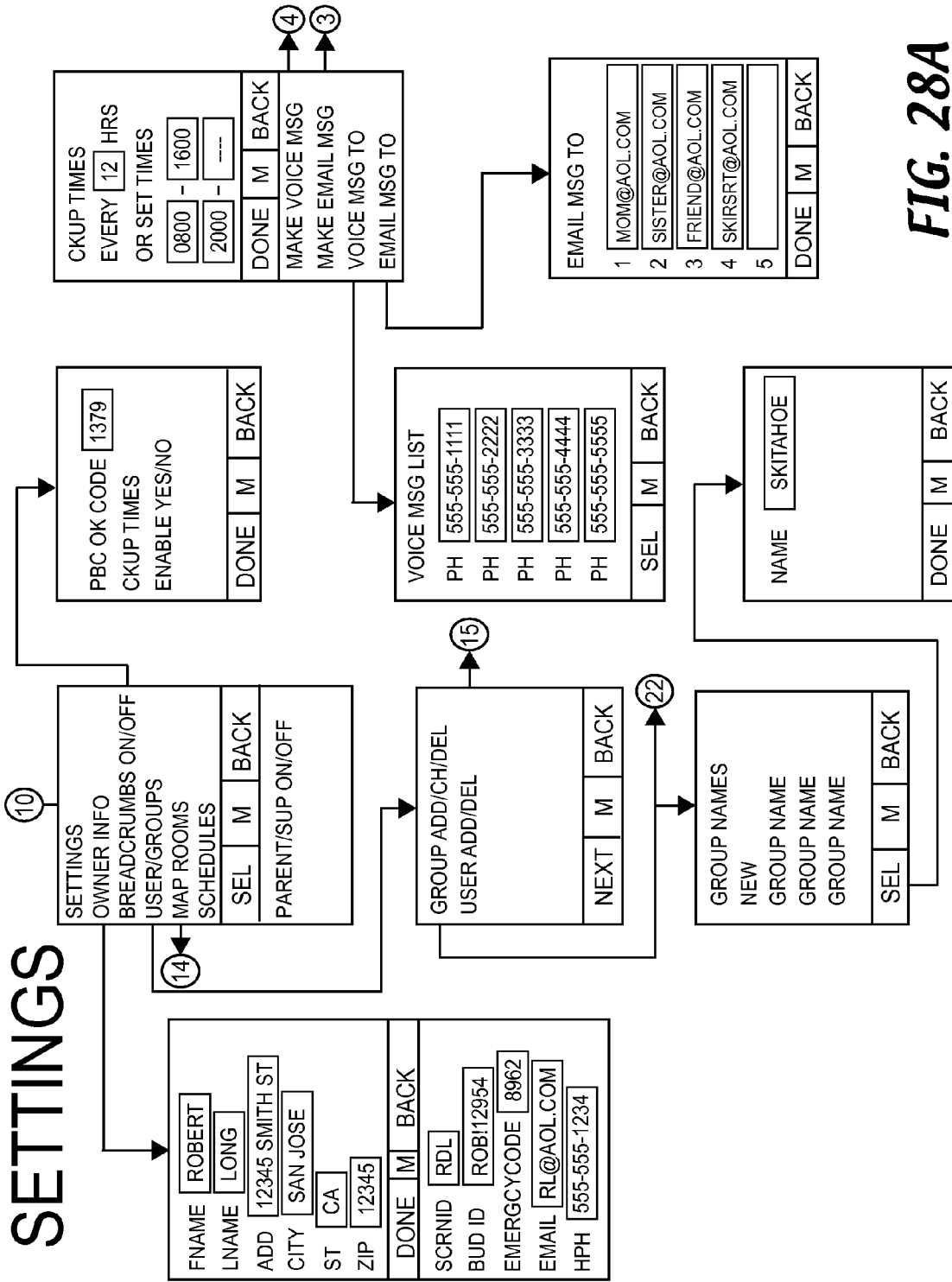

FIG. 28A

SETTINGS (CONT)

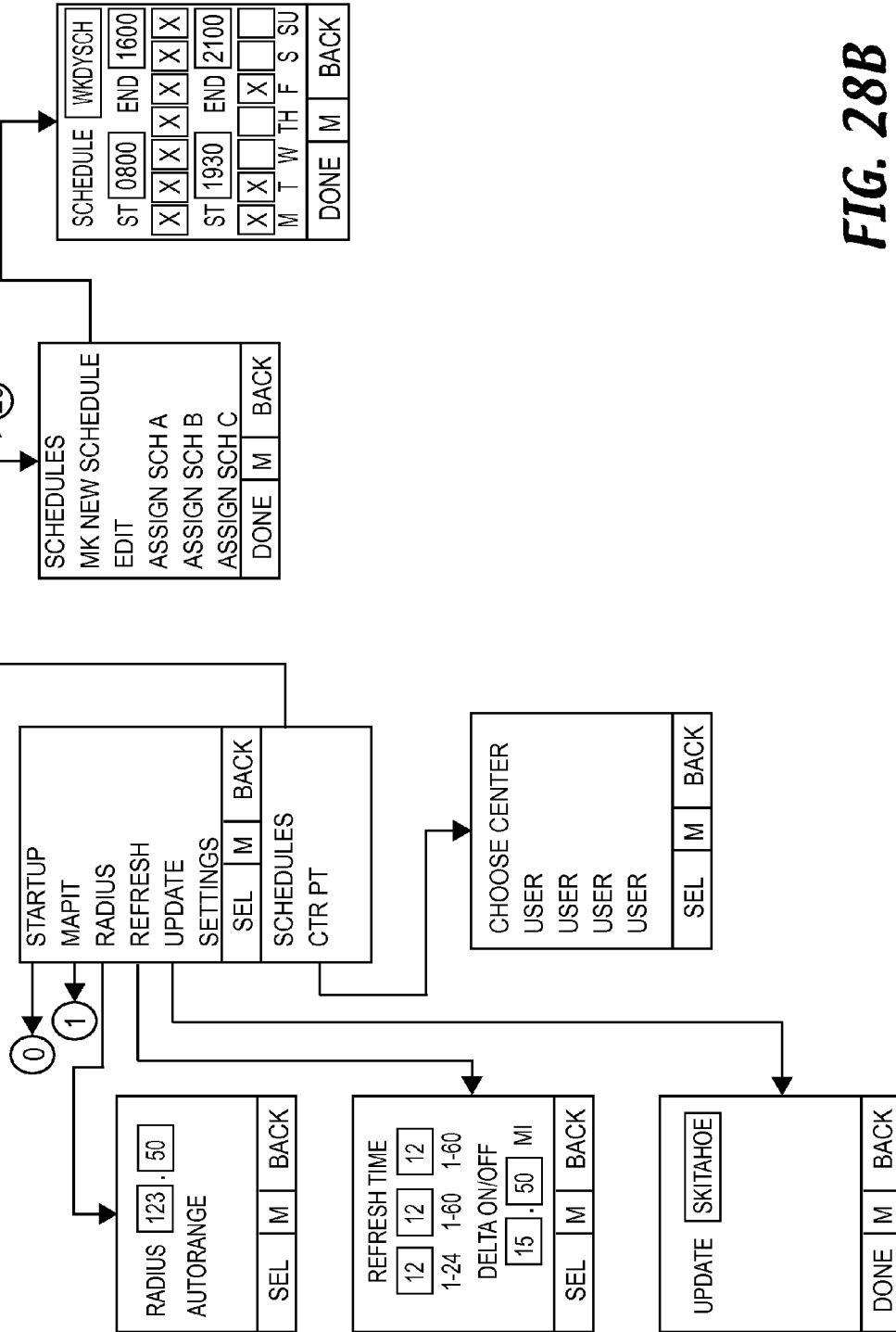

FIG. 28B

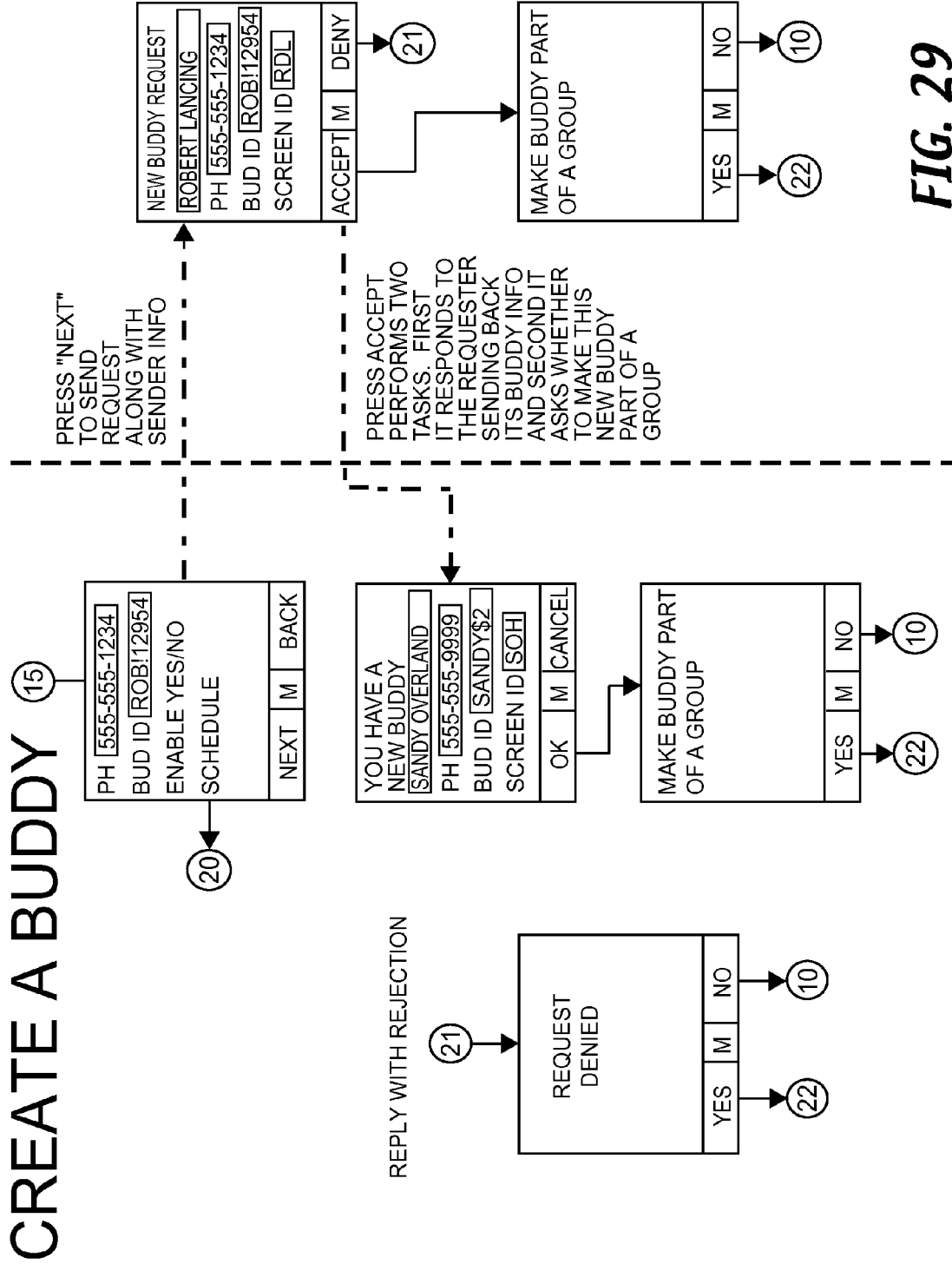

FIG. 29

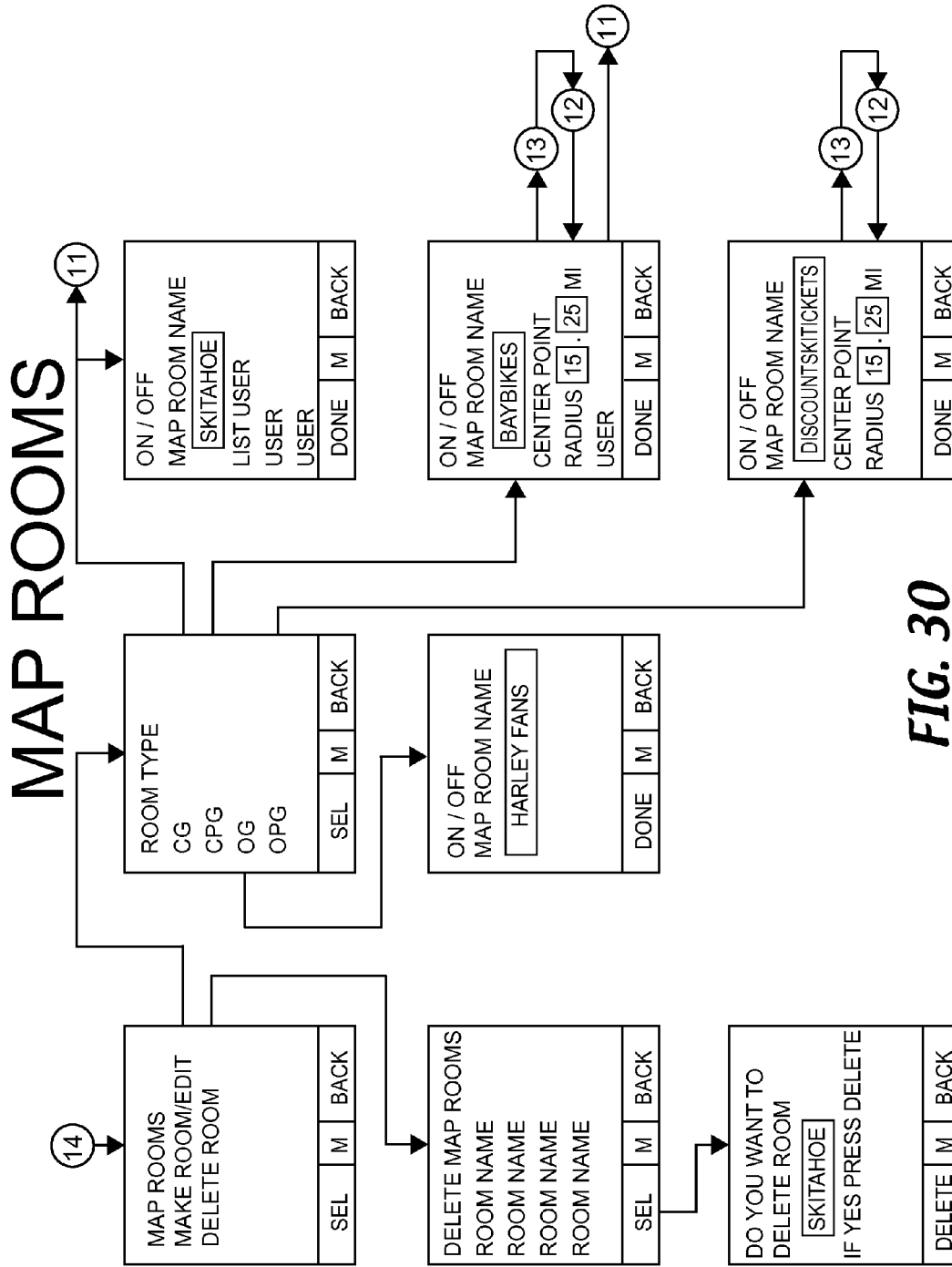

FIG. 30

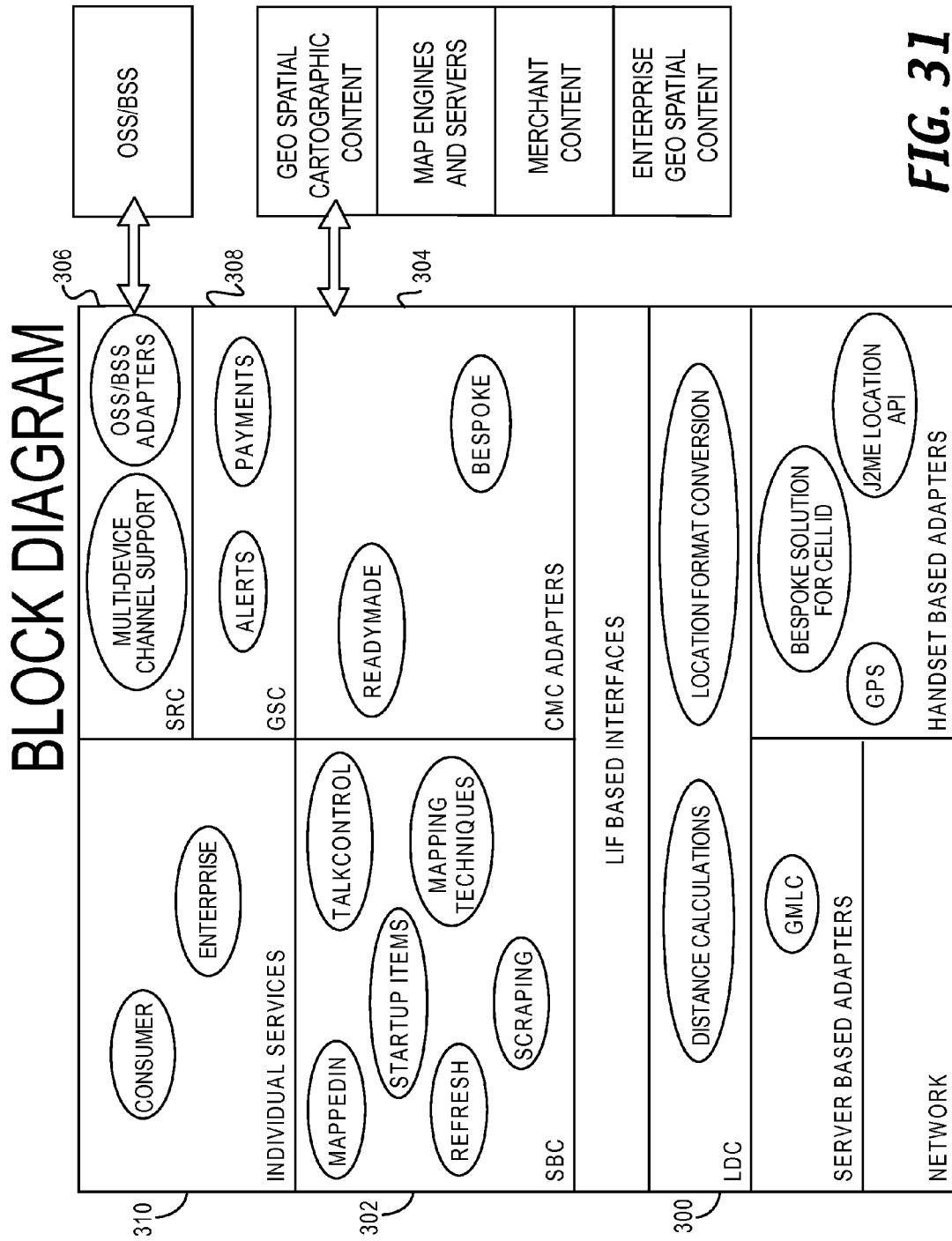

FIG. 31

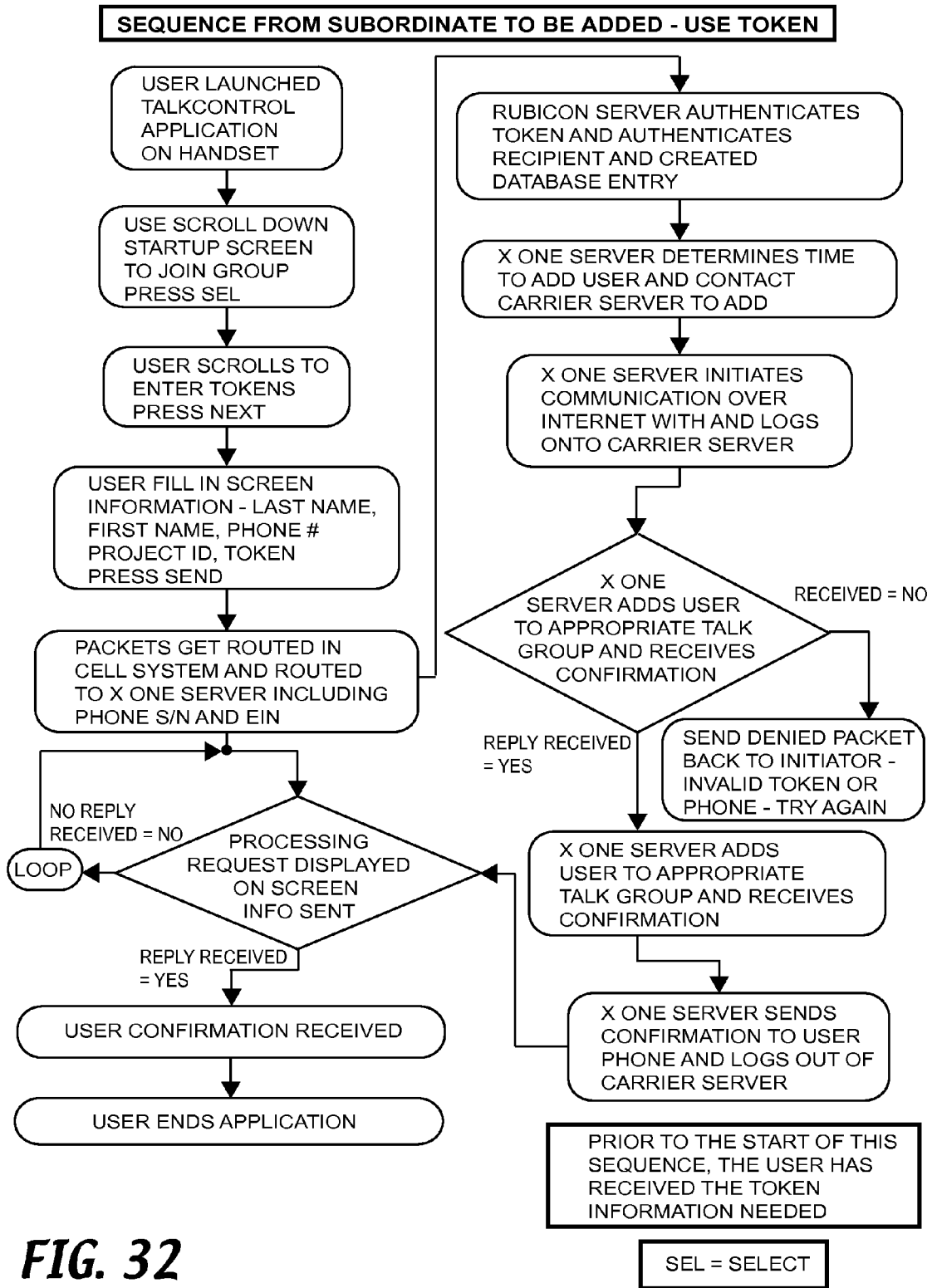

FIG. 32

SEQUENCE FROM SERVER TO AUTO DELETE A USER - SCHEDULE

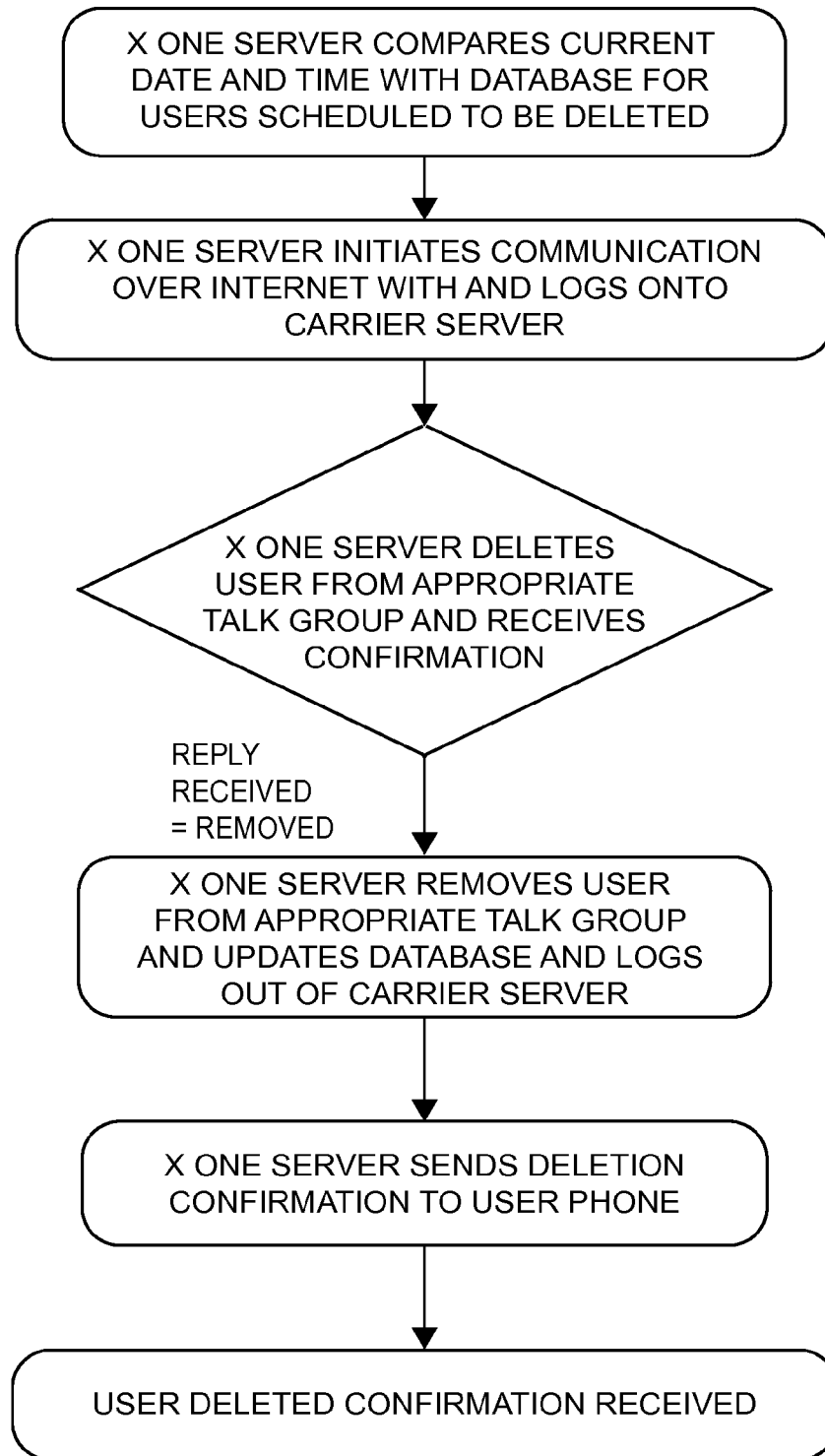
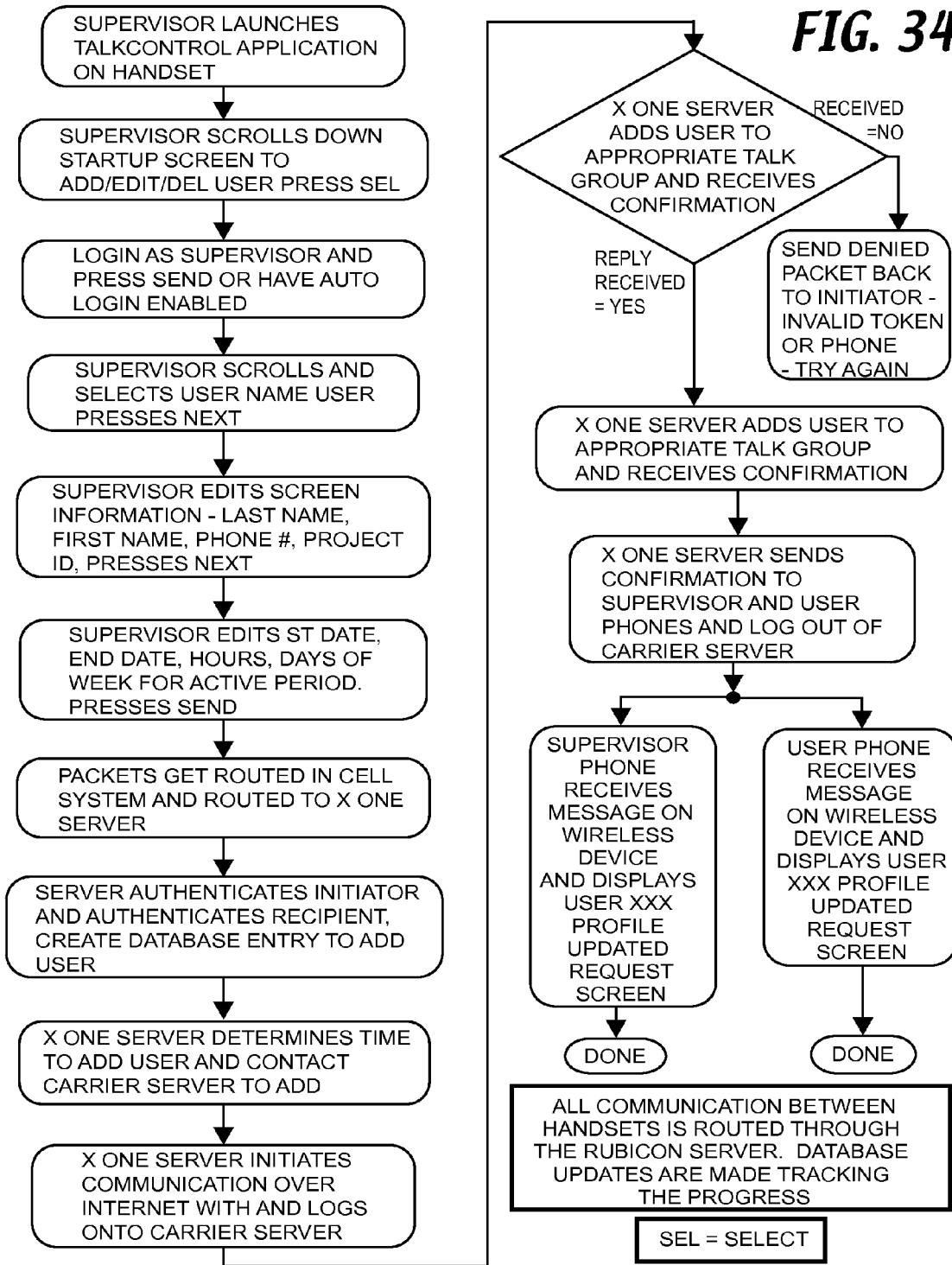

FIG. 33

SEQUENCE FROM SUPERVISOR TO ADD USER



SEQUENCE FROM SUPERVISOR TO EDIT USER

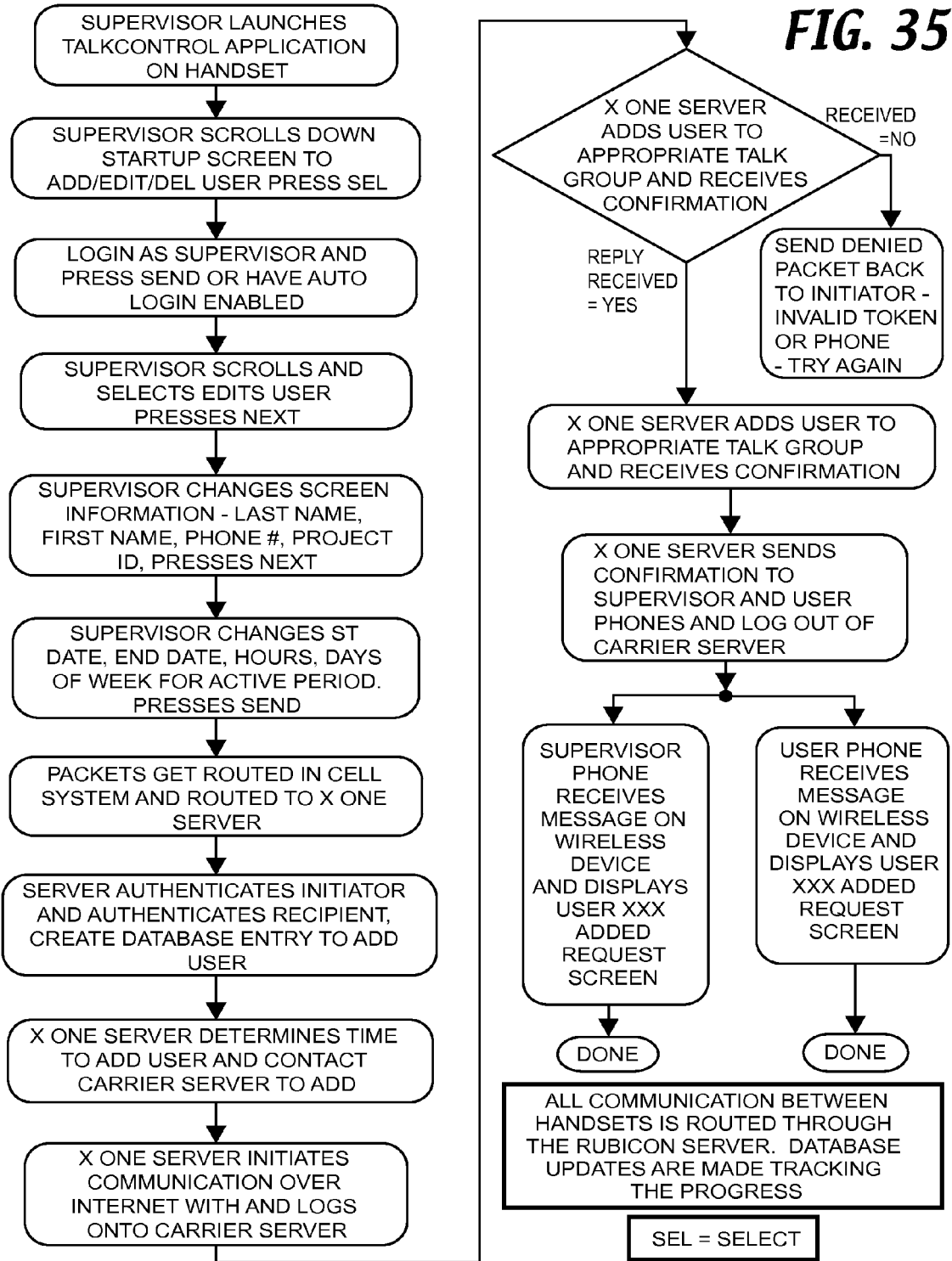
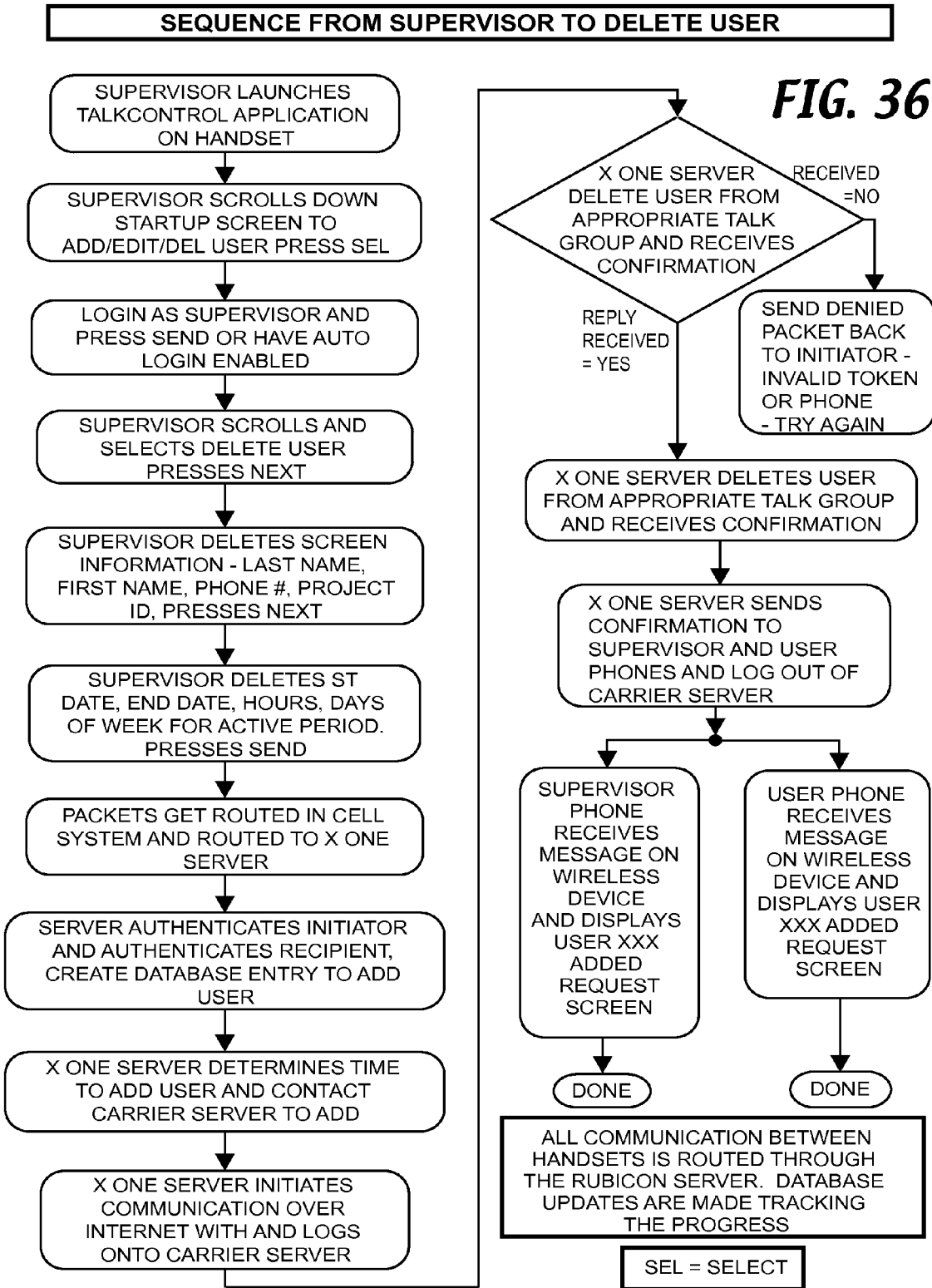

FIG. 35



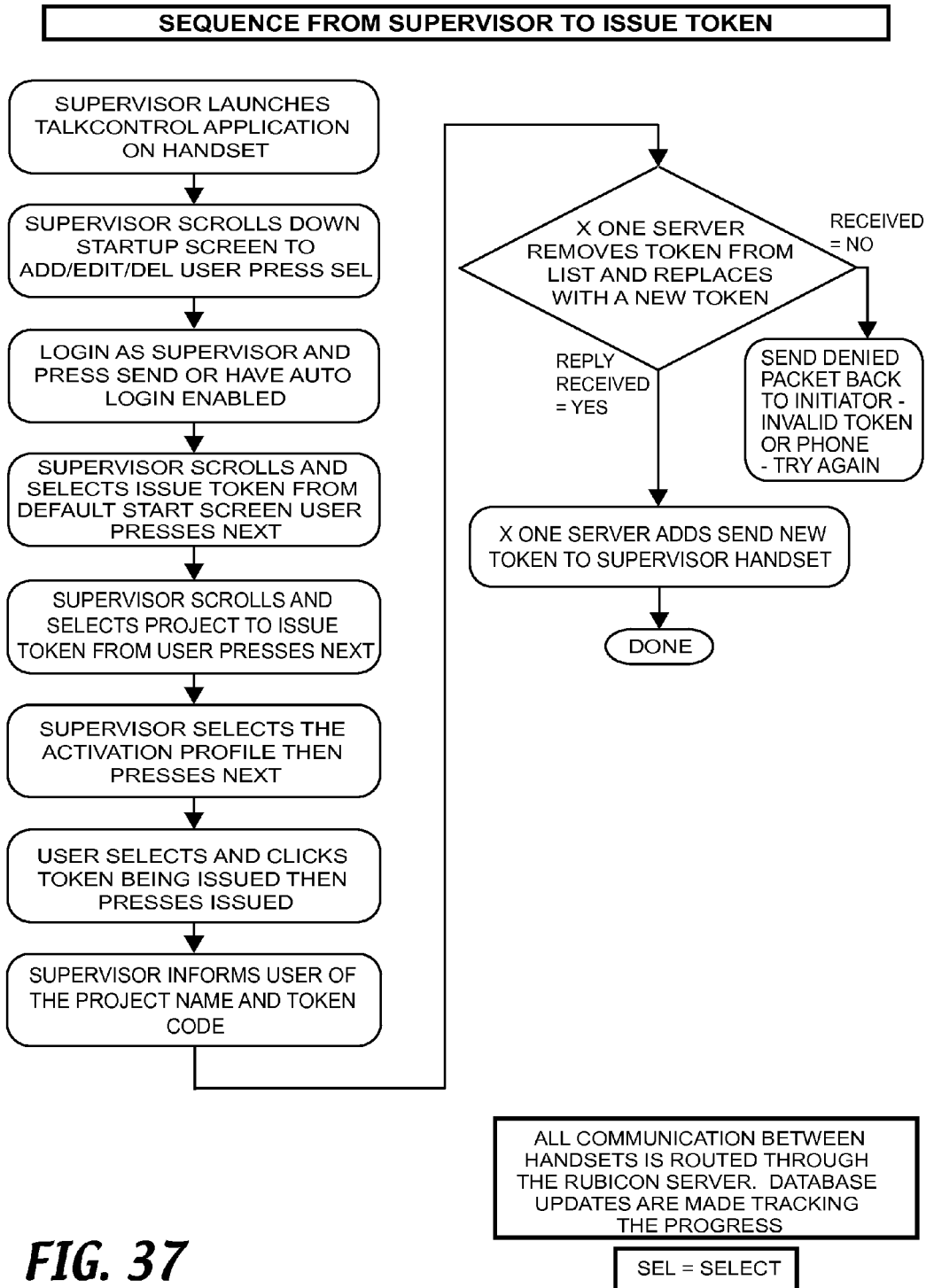

FIG. 37

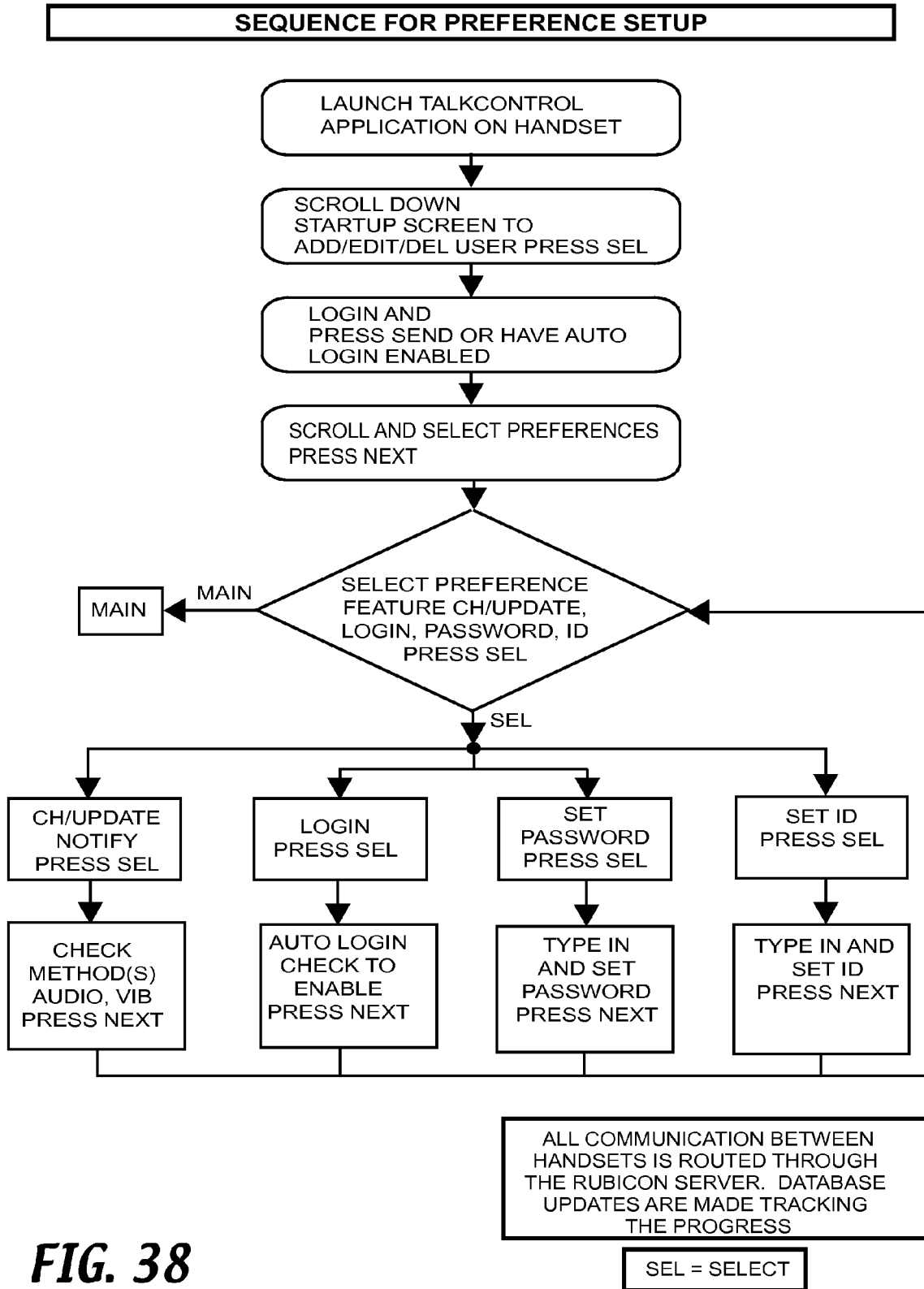

FIG. 38

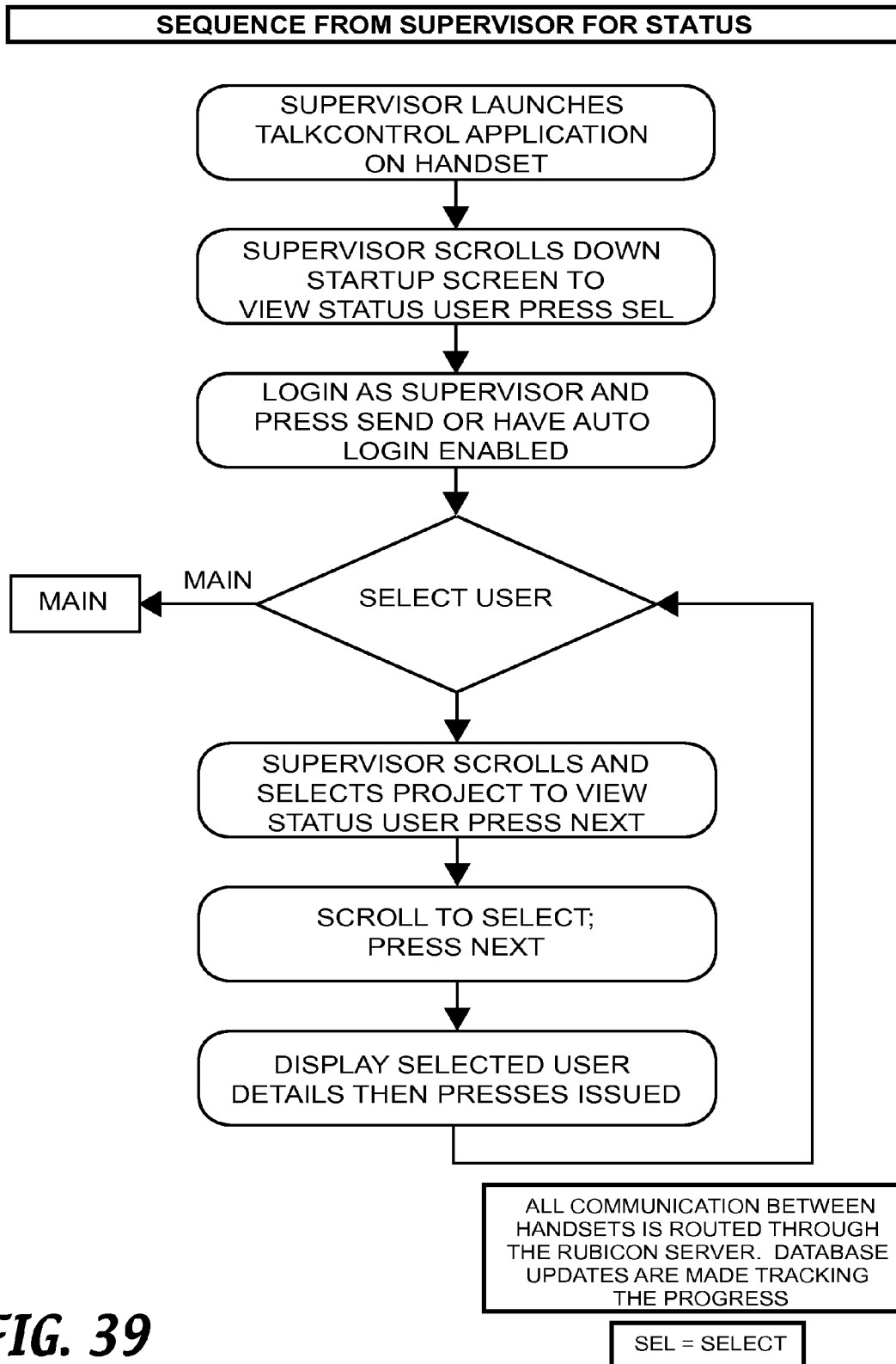
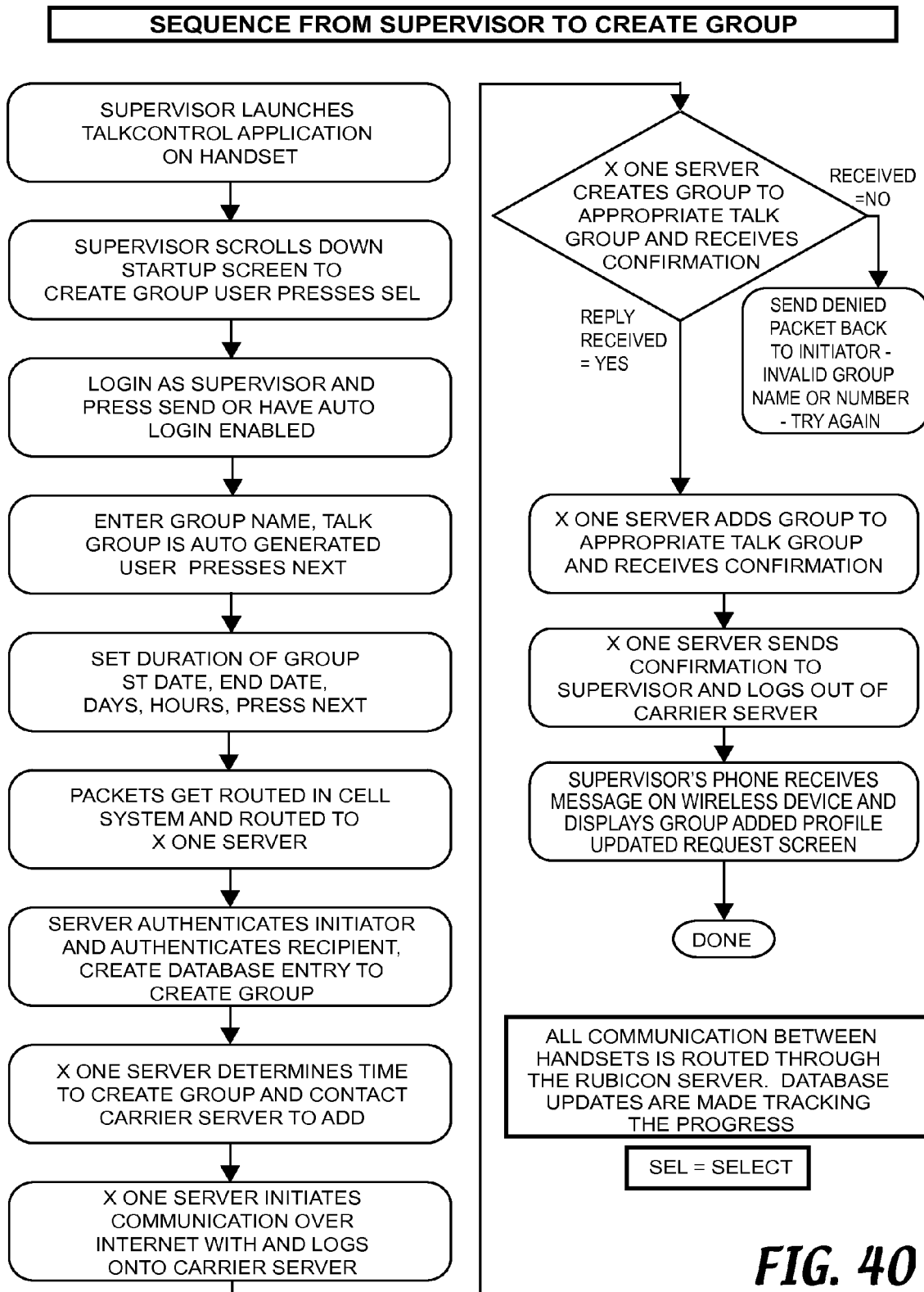

FIG. 39



1

**METHODS AND SYSTEMS FOR
TEMPORARILY SHARING POSITION DATA
BETWEEN MOBILE-DEVICE USERS**

CLAIM OF PRIORITY

This application is a continuation application of U.S. patent application Ser. No. 13/188,414, filed Jul. 21, 2011, which itself is a divisional of U.S. patent application Ser. No. 12/075,408, filed Mar. 11, 2008, entitled "METHODS AND APPARATUSES FOR TRANSMISSION OF AN ALERT TO MULTIPLE DEVICES," which itself is a continuation of U.S. patent application Ser. No. 11/099,362, filed Apr. 4, 2005, now issued as U.S. Pat. No. 7,353,034; each of these applications is entitled "LOCATION SHARING AND TRACKING USING MOBILE PHONES OR OTHER WIRELESS DEVICES." Priority is hereby claimed under 35 U.S.C. §120 or 365(c), and each of these applications is incorporated herein by reference.

FIELD OF USE AND BACKGROUND OF THE
INVENTION

The cellular market in 2003 was around 150-160 million devices in the US and the number is growing at over 10% per year at least. Europe already has 320 million cell phone users, and the global market is over 1.4 billion devices.

Cell phone carriers are looking for opportunities to increase both revenue and profits by providing new services. For example, recently cell phones have been provided with browsers to allow surfing the internet from the phone. One of the needs businesses, families and individuals have is the need to know where their employees, children and friends are. No two way position information sharing technology currently exists as far as the applicant is aware.

The one way location sharing prior art includes On Star and the Mercedes Benz TeleAid services where, via GPS receivers and cellular phone capability built into a car, an aid center can track cars all over the world and speak with the occupants and sense when the cars airbags have deployed. Other commercial services allow parents to track the locations of their children in a one way location sharing manner. None of these services allow the occupants of the car to know where the aid center is or allows the children to know where their parents are.

Another need is for a system for use by motorists, hikers, pilots and boatmen to allow them to be able to contact rescuers and know the location of the rescuers as they come to the aid of the stranded person and to allow the rescuers to know the location of the victims they are trying to rescue. The need requires that cell phones have the capability to be reconfigured in the field to add an "instant buddy" to the list of people with whom location information is shared. The prior art kid tracking systems could not be reconfigured in the field to add new individuals with whom location information was to be shared.

DIFFERENCES OVER KID TRACKING PRIOR
ART

In the prior art, one could buy phones that were set up at the manufacturer to enable parents to locate their children. One such service allows up to eight phones to be used and allows parents to monitor the locations of their kids. But these services do not allow the kids see the locations of their parents because the service is not set up to share location information between phones. In other words, it is a one way service with

2

the kid's locations being sent to the parents phones for display but not vice versa. Further, there is no mechanism to add groups and members of groups, and there is no mechanism to set up "instant buddies" as that term is used below (temporary location sharing between phones on an ask and accept basis which automatically expires after a configurable interval terminates). The kid locator phones are set up at the factory and nothing can be changed in the field by the users and they are always on and cannot be disabled.

It is useful to be able to share locations among multiple cell phones which have GPS locator ability. Such an ability would be useful for people in groups who have made plans to meet at specific locations at specific times. When one person is late, the others in the group would be able to ascertain the tardy person's location. To alleviate privacy concerns, it would be useful to be able to turn off location sharing or to program location sharing so that it turns itself on automatically at some date and time and turns itself off at some other programmable date and time. It would also be useful to have a map display on cell phones which are picture enabled and to plot the locations on the map of persons in a group who have their location sharing capability turned on.

SUMMARY OF THE INVENTION

The invention contemplates 2.5 GHz and 3 GHz Java enabled, web enabled (or similar) cell phones and Personal Digital Assistants or other web enabled wireless products with global positioning system (GPS) receivers and sufficiently large liquid crystal displays for the preferred embodiment. The phones must be web enabled to be able to send and receive TCP/IP or other protocol packets over the internet to the Buddy Watch server.

In some embodiments where push-to-talk enablement is implemented, GPS receivers are not necessary in the cell phones but they must be web enabled to be able to send and receive TCP/IP or other packets over the internet to the Buddy Watch server.

These phones and other wireless devices are programmed with software (programmed at the factory or downloaded from the assignee of the present invention) to have the user interface and functionality described herein to allow mutual tracking and optional position mapping displays of members of groups and of instant buddies coming to the rescue of stranded motorists, hikers, pilots and boatmen. These phones work with a Buddy Watch™ server coupled to the internet. The server is not limited to any specific language or technology nor is it limited to any specific wired or wireless solution or any particular transmission physical layer or protocol.

The teachings of the invention do not require development of new cell phone or PDA technology nor do they require development of new cellular communication infrastructure. The functionality implemented by the software of the invention utilizes existing platforms and infrastructure. In the preferred embodiment, the software of the invention is developed to JAVA specifications.

In its primary mode, the process of the invention only allows exchanging and mapping of position data with persons on a Buddy List™ programmed into a Buddy Watch™ (synonym for Buddy Tracker™) device (defined as any of the devices mentioned anywhere in the specification when programmed to operate in Buddy Watch mode or coupled to another device operating in Buddy Watch mode). The user must allow others on his Buddy Lists to "see" his location (location sharing may be turned off), and the user must request to see the location of others on his Buddy Lists to be able to have their positions reported and/or mapped. Position

information exchanged via radio transmission on the cellular infrastructure is encrypted so that outsiders cannot see or use location information that is transmitted. A simple menu structure allows easy setup and management of Buddy Watch application programs. The keypad of the phone or PDA is used to enter information into the Buddy Watch enabled device. Online help is available to setup and use the Buddy Tracker application program(s).

The teachings of the invention can also be integrated into other products and services such as autos with GPS based navigation systems. This would be done by expanding the navigation system to have a cellular transceiver capable of sending and receiving digital data including position data to the Buddy Tracker server. It could also be done by expanding the GPS navigation system product to have a USB or other interface port to couple the system to a cell phone or PDA of the type described above. This interface would allow the GPS navigation system to receive position data from the wireless digital data transceiver and map the position data on the GPS navigation system display of the auto. Handheld GPS navigation devices can also be expanded by integrating a cell phone therein or providing a port to interface to a cell phone to exchange position information with the Buddy Tracker server.

In a system employing the teachings of the invention, the users can change things on the fly in the field such as: adding groups and members; adding instant buddies, changing the size of the area in which their buddies can be tracked, enabling or disabling the location information sharing function without disabling the phone, etc.

Some of the benefits of the Buddy Tracker technology are that it allows businesses to easily identify which service persons are closest to the next job and to let personnel in the field know the positions of their co-workers and to share their location with their co-workers. Parents can keep track of where their kids are. Friends can keep track of where their buddies are and share their position with their buddies. Location information will be shared only so long as the phone is on and in an area where the device can receive a GPS signal and send the phone's coordinates out on the cellular network (and the location sharing capability is enabled).

Further, the cellular carriers do not have to invest in engineering or infrastructure to offer the Buddy Watch functionality. The software that implements the Buddy Watch functionality can be downloaded from the web or installed at the point of sale of a cell phone or PDA. Use and sale of an application that makes use of the on-board GPS capability of cell phones and PDAs built to comply with the E911 requirement allows the carriers to recoup some of the costs imposed upon them by the E911 requirement.

Enhancements to cellular phones in recent years such as the addition of cameras and web browsers have lost track of one of the basic reasons for cell phones in the first place—people want to communicate with and know where other people are. This is applicable to parental monitoring and increasing the efficiency of business and increasing the effectiveness of law enforcement. The Buddy Watch system also functions to decrease the load on the 911 system since not every situation requires the help of 911 authorities.

BRIEF DESCRIPTION OF THE DRAWINGS

FIG. 1 is a screen shot of a typical opening screen which would be displayed on a cellphone with the BuddyTracker™ software enabled.

FIG. 2A shows a block diagram of the Buddy Watch system.

FIG. 2B illustrates a matrix or web of supervisorial relationships and Buddy Lists.

FIG. 2C is a diagram of the start-up screen.

FIG. 2D shows the Mapit page.

FIG. 2E shows additions options for manual refresh, etc. which can be reached by scrolling down the Mapit page below the list of active users. FIG. 2F is a screen of active users.

FIG. 3 represents a display in the user interface which shows individuals on the phone's Buddy List as well as a group of buddies which has been given the name Tennis Team.

FIG. 4 is a user interface display showing the result when the tennis team Buddy List entry is selected and the information that is displayed when one of the members of the tennis team is selected for display of location information.

FIG. 5 is a user interface display showing a map rendering with the location of a selected member of the tennis team group displayed thereon.

FIG. 6 is a user interface display showing a map rendering with the location history of a selected member of the tennis team rendered thereon.

FIG. 7 is a screen shot of a display in a typical system employing the invention showing positions and status of members of a selected group.

FIG. 8 is a screen display showing what is displayed when Dean is selected and the Mapit command in box 48 is given by double clicking on the box or by any other means.

FIG. 9 is a screen shot of an instant buddy display after an instant buddy relationship has been set up.

FIG. 10 is a screen shot of a typical display in a system employing the teachings of the invention to establish an instant buddy ID in box 70, and give the instant buddy a caller ID in box 72 (the instant buddy's caller ID or phone number is used by default).

FIG. 11 is a screen shot of the display which appears on at least the instant buddy's phone after a stranded motorist, pilot or hiker has contacted 911 and entered a caller ID and carrier for a proposed instant buddy.

FIG. 12 is a block diagram of a typical prior art cellular system infrastructure in which the method and apparatus of the invention work in a peer-to-peer embodiment.

FIG. 13, comprised of FIGS. 13A and 13B, is a flowchart of the method of exchanging GPS position data among cell phones of a watch list.

FIG. 14, comprised of FIGS. 14A, 14B and 14C, is a flowchart of processing of an embodiment that implements several modes of operation.

FIG. 15 is a flowchart of the process of establishing an Instant Buddy Relationship.

FIG. 16 is a block diagram of a typical cellular system coupled by a gateway and a Wide Area Network such as the internet to a Buddy Watch server to provide the infrastructure of the invention.

FIGS. 17A and 17B are a flowchart of the preferred Instant Buddy Setup process.

FIGS. 18 and 19 are diagrams of some of the user interface display screens involved in the Instant Buddy Setup process.

FIGS. 20A and 20B are a flowchart of the process of enabling the personal bread crumbs mode and how it works.

FIG. 21 is a flowchart of another embodiment of a process to establish and use the personal bread crumbs mode.

FIG. 22 is a flowchart of the preferred embodiment for the instant buddy setup process.

FIG. 23 is a flowchart of another embodiment of a process to receive buddy location update requests and process them.

5

FIG. 24 is a diagram of the default start screen and some of the other user interface screens that the user can navigate to from the start screen.

FIG. 25 is a help screen showing how navigation to a view new alarms screen can be accomplished.

FIG. 26 shows the tree structure of a plurality of other screens which can be used to add target locations, annotate the target locations with text, voice or photo notes, add a text message, give commands to take a picture or find a picture file, record a voice message to be appended to the target, request position updates for all active buddies, map the positions of all active buddies or select particular buddies for mapping or requesting a position update.

FIG. 27 shows a number of screens which can be displayed to map the position of a selected user with history and give information about the user as well as send short text messages, record and send voice messages, photos, Instant Messenger links, target positions, etc.

FIGS. 28A and 28B show user interface screens created by Buddy Tracker software to create settings such as bread crumbs on or off, security codes for personal bread crumbs tracking and verification that a user is OK, set checkup timeout intervals, establish phone numbers and email addresses of other users to call in case of emergency in personal bread crumbs mode, add, change or delete group names, set the Mapit screen radius, refresh rate and update setting, refresh time, delta position change for refresh.

FIG. 29 shows the user interface screens to create a new buddy and showing the communication paths and accept protocol to do this.

FIG. 30 is a diagram of the user interface screens for defining, deleting and using map rooms for closed proximity groups, open proximity groups, etc.

FIG. 31 is a block diagram of the system for TalkControl to simplify cell phone walkie-talkie operations.

FIG. 32 is a flow diagram of a process a user of a walkie-talkie enabled phone can initiate to join a talk group to enable subsequent walkie-talkie operations.

FIG. 33 is a flowchart of the process the Rubicon server carries out to automatically delete a user.

FIG. 34 is a flowchart of the process the Rubicon server carries out to allow a supervisor to add a user.

FIG. 35 is a flowchart of the process for a supervisor to edit a user in a talk group.

FIG. 36 is a flowchart of a process for a supervisor to delete a user from a talk group.

FIG. 37 is a flowchart of a process for a supervisor to issue a token.

FIG. 38 is a flowchart for the process of setting up preferences.

FIG. 39 is a flowchart of the process to allow a supervisor to request status.

FIG. 40 is a process flowchart of the process for a supervisor to create a group.

DETAILED DESCRIPTION OF THE PREFERRED AND ALTERNATIVE EMBODIMENTS

FIG. 1 is a screen shot of a typical opening screen which would be displayed on a cellphone with the Buddy Tracker™ software enabled on the phone. FIG. 2A is a block diagram of the Buddy Watch system. A Buddy Watch or Rubicon server communicates with wireless devices 2 through 6 via the internet 9 and wireless carrier systems 7 and 8. In the claims, the Buddy Tracker software is called the GPS position data sharing software application and it is resident on each of wireless devices 2 through 6. Generally, communication between the

6

handsets and the Rubicon (Buddy Watch) server occurs as follows. Each handset communicates data packets through its local cellular carrier network via TCP/IP compliant data packets encapsulated in cell system packets. The carrier network tower receives the packets and strips off the cellular encapsulation and forwards the TCP/IP packet to an appropriate gateway connected to the internet 9. Routers in the internet route the packet to its destination, generally the Buddy Watch server 1. The receiving server validates the content of the IP packet to authenticate the sender as a registered Rubicon user and to verify that the sending phone EIN matches the phone EIN stored in the server. Once authenticated, the packet content is processed by the server. A response to the request in the packet is prepared using information from a database maintained by the Rubicon server and any associated map needed for the response is requested from a map server. The complete response is compiled, including any data needed to render a map on the recipient wireless device display and packetized into a TCP/IP packet and sent back to the originator of the request via internet routers and carrier gateways that couple the wireless carrier systems to the internet. The gateway of the carrier identifies the correct tower for the cell in which the recipient's phone is currently resident and the packet is encapsulated in a cell system packet and forwarded to the appropriate tower where it is transmitted wirelessly to the cell phone or other wireless device of the recipient. The wireless device then recovers the data in the TCP/IP packet and the port address in the TCP/IP packet header causes the packet to be routed to the Buddy Watch software where it is processed.

FIG. 2C is a diagram of the start-up screen. On startup, each handset starts its GPS sampler and the Buddy Watch application program. If Main is pressed, the user is taken to the Nextel default page (or whatever other carrier is being used). If Mapit is selected, the user is taken to the Mapit page shown in FIG. 2D. FIG. 2D shows the Mapit page where the positions of active users within the radius set up in the preferences of the center point XXX within radius YYY is shown. Scrolling down the Mapit page below the map is the list of active users including those outside the radius. FIG. 2E shows additional options for manual refresh, etc. which can be reached by scrolling down the Mapit page below the list of active users. FIG. 2F is a screen of active users. Color is used to highlight items. Scrolling to a user and pressing OK gives two options: re-centering the map on the user and displaying details of that user.

The Buddy Tracker software creates the displays such as that shown in FIG. 1 and other user interface displayed discussed elsewhere herein. FIG. 24 is a diagram of the default start screen and some of the other user interface screens that the user can navigate to from the start screen. This is a help/emergency screen 15 which has a next command 19 which can be selected to take the user to the 911 screen 17 which can be used to take the user to a screen 21 wherein the user can select the type of help requested. FIG. 25 is the help screen and shows how navigation to view a new alarms screen can be accomplished. FIG. 26 shows the tree structure of a plurality of other screens which can be used to add target locations, annotate the target locations with text, voice or photo notes, add a text message, give commands to take a picture or find a picture file, record a voice message to be appended to the target, request position updates for all active buddies, map the positions of all active buddies or select particular buddies for mapping or requesting a position update. FIG. 27 shows a number of screens which can be displayed to map the position of a selected user with history and give information about the user as well as send short text messages, record and send

voice messages, photos, Instant Messenger links, target positions, etc. FIGS. 28A and 28B show user interface screens created by Buddy Tracker software to create settings such as turning bread crumbs on or off, security codes for personal bread crumbs tracking and verification that a user is OK, set
5 checkup timeout intervals, establish phone numbers and email addresses of other users to call in case of emergency in personal bread crumbs mode, add, change or delete group names, set the Mapit screen radius, refresh rate and update setting, refresh time, delta position change for refresh. FIG. 10 29 shows the user interface screens to create a new buddy and shows the communication paths and accept protocol to do this. FIG. 29, is discussed more below, and is a representation of the screens and protocols to initiate and accept an instant buddy relationship. FIG. 30 is a diagram of the user interface
15 screens for defining, deleting and using map rooms for closed proximity groups, open proximity groups, etc. For closed proximity group map rooms, listed users can set their preferences to automatically enter or be alerted that they are in the Zone and manually decide to enter. For Open Proximity Group Map Rooms, anyone can join by opting in from their phone or from a sponsor's website. Upon entry, they can view and be viewed by all other members in the map room. Proximity rooms are useful to find and be found by friends attending an event.

In FIG. 1, area 10 discloses that the Buddy Tracker location sharing application software is active and is sharing the location of the phone with other members of a designated group. Area 12 indicates that parental status is active which means that the employer of the employee carrying the phone or the parent of the kid carrying the phone can see the location of the employee or kid if the phone is on. When parental status is active, the supervisory function cannot be turned off or evaded. This supervisory location sharing can be hierarchical such that an employer can see the location of all its employ-
20 ees, and each of the employees can be set up as supervisor of their children such that the employees can see the locations of their children, but the employer of each employee cannot see the locations of the children of each employee. The supervisory relationships can be set up to define a matrix or web of Buddy List and supervisory relationships, such as is illustrated in FIG. 2B.

In FIG. 2B, phone A has phones C and D on its Buddy List and is set up as the supervisor of those two phones. Phone B has phones A, G, F and E on its Buddy List and is set up as
25 a supervisor of those phones. Phone H has phones E, J and I on its Buddy List and is set up to supervise those. Phone K has phone I on its Buddy List and is set up to supervise phone I.

Each of the phones in FIGS. 2A and 2B is coupled to the cellular carrier infrastructure in a conventional manner and can send phone calls or short text messages or email messages to any other phone including the cell phones represented by lettered circles in FIG. 2B. FIG. 12 is a block diagram of a typical prior art cellular system infrastructure in which the teachings of the invention in a peer-to-peer embodiment can be practiced. An area of the country is divided into several
30 cells represented by circles such as 93 and 95. Inside each cell is a transceiver tower, represented by blocks 94 and 96 which carries out time division multiple access or code division multiple access digital radio communications with cell phones in its cell. The cell phones or PDAs are represented by autos 98 and 100. Data recovered from the cell phone transmissions is transmitted to a central switching system 102 by data paths such as 104 and 106. The central switching system 102 is coupled to a public service telephone network 108.

Transmissions from one cell phone to another take place via the towers such as 94 and 96 and the central switching

system 102. For example, suppose cell phone 98 wants to send its GPS location data to cell phone 100 and cell phone 100 wants to send its GPS location data to cell phone 98. The system of the invention uses some communication protocol such as XML, modified short text messages or other methods to send GPS location information to all cell phones on a Watch list. XML is a slimmed down version of SGML and enables Web authors to create their own tags so that they can more accurately capture the structure of their data. Because this structure can be read by SML-compliant browsers, the information encoded in these tags can be made available to programs such as Java applets or it can be displayed by formatting the XML tags with a style sheet.

In the preferred embodiment, the wireless devices in a group which has location tracking turned on periodically send their GPS position data to all the other members in the group. The process for each wireless device to send its position data to any other wireless device in the group is as shown in FIGS. 13A and 13B. Basically, FIG. 13 is a flow chart of the process of two or more cell phones exchanging encrypted GPS position data. FIG. 23, discussed below, is a flowchart of another embodiment of a process to receive and process Buddy location update requests. The process of FIG. 13 starts at step 110 with a request for a position update. In the preferred embodiment, this happens when a user of a Buddy Tracker phone uses his phone to make a request for a location update. In other embodiments, location updates can be requested automatically and periodically by the Buddy Tracker software on a device that is reporting its position. In other embodiments, a position update can be automatically generated by a device which is reporting its position to other members of a group whenever the position of the device has changed from its last reported position by a programmable amount. The requested position update may be sent to everybody on a selected Buddy List or just a single person's wireless device. In some embodiments, the position update is sent to some subset of persons on a selected Buddy List. Step 112 represents the process of looking up the addresses for all people on the selected Buddy List, a watch list, or just a selected individual or a subset of individuals from a watch list, as the case may be. Some embodiments may be limited to position updates on entire Buddy Lists.

Step 114 represents the process of reading the GPS position data from the built in GPS receiver of the phone (or the GPS receiver of the navigation system) and encrypting the position data.

In step 116, cell phone 98 puts its encrypted GPS location data into a message according to the chosen communication protocol (assume short text message—SMS for short) and addresses the message packets to the one or more phones of the selected persons with which position information is to be shared.

In step 118, the SMS message packets are transmitted to tower 94 using whatever physical layer protocol the cellular system uses such as TDMA or CDMA. The header of the SMS packets contains data indicating the payload data is to be sent to the Buddy Watch software of a particular cell phone and not to the inbox of the phone's SMS software. The payload data of these packets is the encrypted GPS position data. The physical layer protocol typically involves the following steps. First, the packets are disassembled into groups of bits of some predetermined size called codewords the size of which depends upon the particular configuration of the forward error correction software. The codewords are then interleaved to help defeat burst errors. Each codeword can then be encoded with error detection and correction bits such as by using Reed Solomon encoding. The codewords are then bro-

ken down into groups of bits called constellation points. The number of bits in each group depends upon the type of modulation scheme in use. In some embodiments, the groups of bits are then further encoded in a Trellis encoder.

The encrypted GPS position data packets would be addressed such that they would be routed in the cellular system to all the other wireless devices using the Buddy Tracker software which requested a position update. This is done by routing the packets to the cell transceivers in the cells in which the wireless devices which require updates are currently registered, as represented by step 120. For example, if cell phone 100 in FIG. 12 is on the Watch list or is being automatically updated or has requested a position update manually, it will have transmitted a packet to transceiver 96 indicating it needs a position update and, when the wireless device entered cell 95, it will have exchanged packets with transceiver 96 to achieve synchronization with transceiver 96 and to register in cell 95. Each wireless device that is registered in a cell will have done this, and the transceivers in each cell will communicate with the central switching system 102 to indicate which wireless devices are registered in their cells. Therefore, the routers in central switching system 102 will know which wireless devices are registered in each cell and will know which wireless devices are to receive position updates. Step 120 represents the process of receiving the signals from each wireless device that are modulated with constellation points that contain the data of packets that contain GPS positions, recovering the data from the constellation points and doing error detection and correction and recovering the GPS position data packets. These packets are then routed to the central switching system which uses the destination addresses in the packets and its routing tables to route them to the transceivers in whatever cell or cells the wireless devices that require position updates are registered. There, the packets are disassembled, encoded with error correction and detection data, and assembled into symbols or constellation points in whatever type modulation (QAM, QPSK, etc.) is being used and transmitted to the wireless device. This happens for every wireless device on a watch list or which has requested a position update.

At each wireless device which receives the signals modulated with the constellation points bearing the GPS position data, the data of each packet is recovered and the packet is reassembled, as symbolized by step 122. The header data of the packet (the port number in the case of TCP/IP packets) causes the wireless device to pass the packet to the Buddy Tracker software which is monitoring a particular port, step 124. When a packet is passed to that port (or just the payload data thereof), the payload data is decrypted and the position data recovered, step 126. Step 126 also represents the process of reading the header data of the incoming packets and determining which other member of a buddy group sent the position update so that the position information for the proper member of the Buddy Group is displayed. The position data is then used to display the position of the other party in the group who sent the packet, and, if the user gives the "Mapit" command, the position data will be converted to a waypoint on a displayed map so as to graphically display the position of the wireless device which sent the packet.

Step 128 represents the process of the device which received the position update encrypting its own GPS position into short message or email packets addressed to the other members of a Buddy Watch group or to a single other wireless device. These packets are then sent to all the other wireless devices by the same process described in steps 116, 118, 120, 122 and 124 of FIGS. 13A and 13B, as represented by step 130.

FIG. 23 is a flowchart of another embodiment of a process to receive buddy location update requests and process them. Step 220 represents requesting a buddy location update. Addresses of all persons on the buddy list or just a selected buddy are located in step 222. Message packets are generated in 224 addressed to the selected Buddy List or individuals, and encrypted position data is put in them. A request is sent—226, and these packets get routed to the Rubicon server—228. The initiator and recipient are authenticated—230, and the packets are forwarded to the recipients via the cell system. The cell system forwards the packets to whatever cell each recipient is in—232. The packet arrives and causes a GPS position request to be made in each wireless device—234. The device captures its current GPS position, and encrypts it and packetizes the GPS position in the payload portion of a packet addressed to the Rubicon server with information as to the requestor in some embodiments. The packet is then sent with a timestamp to the Rubicon server for forwarding to the requesting Buddy—238 and 240. The Rubicon server authenticates the initiator and the recipient and forwards the packet to the initiator via the cell system—242. The cell system forwards the packet to the cell where the initiator recipient is located—244. The initiator's cell phone receives the packet, and recovers the timestamp—246, and reads the packet header and port number of the GPS information and uses the port number to route the packet to the Buddy Tracker software—248. The Buddy Tracker application program on the initiator's cell phone receives and decrypts the GPS information from the packet, displays the position of the Buddy, and uses information in the header to determine which other Buddies sent position updates—250. The wireless device of the initiator responds to the position update of each Buddy by sending a reply packet with the encrypted position of the initiator—252. Each requested Buddy device updates the Rubicon server and the wireless device of the requesting buddy with its position—254.

Out of Coverage Update Response

In some embodiments, when a wireless device requests an update from another wireless device, and the other wireless device is out of cellular coverage, a timeout occurs. When a timeout occurs without receiving a position update, the wireless device expecting the update changes its display to yellow or some other color for the wireless device which is out of coverage. The Buddy Watch system only works when the phone is on and in a cellular coverage area.

Buddy Watch Modes

FIG. 14, comprised of FIGS. 14A, 14B and 14C is a flowchart of processing of an embodiment that implements the several modes described below. The steps that are numbered with like numbers to steps in FIG. 13 represent the same functionality.

1) Disable: The Buddy Watch application can be disabled by the user. When disabled, the wireless device does not share its GPS position data with any other wireless device so no other buddy can see your position. There is an exception for the parental monitoring function. When parental monitoring is turned on, as symbolized by line 111 in FIG. 14A, the wireless device always shares its GPS position and cannot be disabled. The disable functionality is represented by test 113 in FIG. 14A which determines when a position update is requested whether the Buddy Watch function has been turned off. If so, processing proceeds to test 115 which determines if parental monitoring is turned on. If not, processing proceeds back to step 110 along line 117 and GPS position sharing does not happen. If the Buddy Watch function has not been disabled, processing proceeds to step 112 to look up the addresses of the wireless devices to which the position update

11

is to be sent. When the Buddy Watch application is disabled and it has been operating and parental monitoring is not turned on, a final position update is sent to those wireless devices on the current Watch List (the wireless devices which are active and monitoring each other's positions).

2. Enable: This is the normal mode of operation. Buddies can be added or deleted from the Watch List at any time. Any wireless device that is operating and on the Watch List can find the location of any other device on the Watch List by issuing a position update request. If a buddy is removed from a Buddy List, he or she is not able to receive position updates. Multiple lists can be joined to form a group.

3. Supervisor—Parental/Corporate Code: In this mode, as long as the wireless device of the worker or child is on, the supervisor will be able to monitor position by GPS position updates. The worker or child will not be able to disable the Buddy Watch feature nor remove the parent or supervisor from the Watch List. Only the supervisor or parent will have the necessary password to remove himself from a Buddy List or watch list.

4. Buddy Lists: This is the normal mode of operation. Buddies can be added or deleted from a list at any time. If a buddy is off a Buddy List, he cannot receive position updates from any other wireless device on the list. Multiple Buddy Lists can be joined into a group and entire groups may be enabled and disabled. Workgroup lists are lists of buddies which need to be aware of the location of their coworkers during working hours but not after. Buddy Lists or Buddy Groups are a means to have a single icon, folder or some similar graphic user interface (GUI) mechanism to represent a list of people and enables single commands to turn on or turn off tracking of a group of people. If a folder is used for each Buddy Group, a drop down list showing the specific names and locations of each person on the list can be displayed when the folder or icon representing the group is selected. If an icon is used, the Buddies would be grouped in and shown on the phone display. Groups receive a color on the GUI and the members of the group are connected by a translucent shaped outline encompassing all the points representing positions on the Mapit display. If the group is spread too far apart to be shown on a single Mapit display, then the shaped outline for the group is not shown and on the specific color coded Buddy positions that can be shown are shown. If the Mapit display is zoomed out, the translucent group outline returns when all members of the group can be shown on a single screen. Buddies that are in multiple groups are colored a non group color or the color of any of the displayed groups. If groups overlay and when Buddies that are in two active groups are shown, the translucent outline shall overlap as needed, and only cover Buddies that exist in both lists.

5. Instant Buddies: Instant Buddies can be created when a call is placed between two cell phones, phone enabled PDAs or other wireless Buddy Watch enabled devices. FIG. 15 is a flowchart of the process of establishing an Instant Buddy Relationship. The first step is 132 where the wireless device places or receives a call from a Buddy Watch enabled wireless device to or from another Buddy Watch enabled wireless device. The two users such as a stranded motorist and a tow truck driver discuss the situation and decide to establish an Instant Buddy relationship. After the call is established, and the two agree to allow it, the two wireless device users can click on the Instant Buddy menu choice in the Buddy Watch menu, as symbolized by step 134. The wireless devices then each display an Instant Buddy Setup screen like that shown in FIG. 11 (step 136) and fill in the appropriate data (fields 84, 88 and 86) in step 138. Both users then indicate their acceptance

12

(field 92 or deny the relationship (field 90), or in some embodiments, only the recipient of the call needs to accept or deny the relationship. Once the Instant Buddy relationship is accepted, the two wireless devices start exchanging position data (step 140). After 24 hours, or some other time set in the Instant Buddy preference menu (timeout checked in step 142), Instant Buddies are discarded (step 144). The Instant Buddy preference menu allows the time period for the Instant Buddy relationship to be set to something other than the default value of 24 hours.

Preferred Instant Buddy Setup Process

FIG. 16 is a block diagram of a typical cellular system coupled by a gateway and a Wide Area Network such as the internet to a Buddy Watch server to provide the infrastructure of the invention. The cellular system shown in FIG. 16 is typical and has the same structure and operation as the cellular system of FIG. 12. What is new is the connection between the central switching system and a Buddy Watch server 146 through gateway 148. The purpose of this will be made clear in the following discussion of the preferred Instant Buddy setup process.

Buddy Watch Server Functions

The Buddy Watch server's main function is to serve maps to the cell phones registered in the Buddy Watch system and implement GPS position data exchanges between itself and the phones on a buddy list to enable members of a buddy list to view the locations of other members of the list. In some embodiments, the Buddy Watch server also downloads application software as needed to phones registered in the system as the phones send packets to the Buddy Watch server indicating a particular command has been given which requires an application program on the phone which is not present.

In the preferred embodiment, the Buddy Watch server runs all the application programs on the server and just sends pages to be displayed on the phone to solicit the user to enter data needed to implement a function.

If the phones had as much memory as the Personal Digital Assistants, the application programs could be loaded and run on the phones themselves.

Other functions of the Buddy Watch server are: setup of user profiles, billing and database access and maintenance. Purchase/Payment Activate Deactivate Key

The functions of the Buddy Watch server will be made clear in discussions which follow. But one of its functions will be to manage activate and deactivate codes. The Buddy Watch application will be a service which a cellular carrier offers on a subscription basis. When a subscriber buys a Buddy Watch enabled phone, he will be issued an activation code and the Buddy Watch server will also be given the activation code. This activation code will be kept in active status as long as the subscriber has paid for the service. Subsequent communications of packet data between the Buddy Watch server and the phone such as downstream position updates of positions of buddies on a Buddy List, receipt of phone position for use in updating other buddies on a Buddy List, etc. will only be enabled as long as the activation code is in active status. When the subscriber stops paying for the service, the activation code will be changed to a deactivation code status, and subsequent communication between the phone and the Buddy Watch server will be impossible. The Buddy Watch server implements this functionality by checking the activation code status each time before communication with a phone is carried out.

The Buddy Watch application is downloaded via the internet for subscribers who do not already have it on their phones. The customer receives an activate code to key into the phone, or an activation application on the Buddy Watch server

13

receives confirmation of the purchase and automatically sends the activate code to the phone/Personal Digital Assistant and receives back a confirmation. Each month, payment for the service is required. Failure to make the payment results in an application receiving a request to deactivate the Buddy Watch application on the phone/PDA. A deactivate code is sent and a response is received back confirming the phone application has been deactivated. Further attempts to use the application are met with a simple display indicating the service subscription has expired.

The protocol to activate and deactivate the Buddy Watch application is secure in the preferred embodiment.

FIGS. 17A and 17B are a flowchart of one embodiment for an Instant Buddy Setup process. FIGS. 18 and 19 are diagrams of some of the user interface display screens involved in the Instant Buddy Setup process. All three figures will be referred to in the following discussion. In the preferred embodiment, the Instant Buddy relationship is set up in the following manner.

- 1) An initiator selects the Instant Buddy menu choice options in step 150. This is done by selecting menu option 151 of screen 153 in FIG. 18. This causes a transition to display screen 155 on the initiator's device where the user selects menu option 157. This causes a transition to screen 159 on FIG. 19 which is the Instant Buddy setup screen. This screen shows the initiator's phone number, Instant Buddy ID and Screen ID in auto filled fields 161, 163 and 165, respectively (step 152). There is also a timeout field 167 which the initiator can set to some time if the default time of midnight is not acceptable (step 154). After filling in the timeout value, the Initiator clicks Next in field 169.
- 2) Instant Buddy request packets are generated and sent to the cell transceiver of whatever cell the wireless device of the initiator is registered. These packets contain data which identifies the initiator and the recipient (proposed Instant Buddy) and are addressed to the IP address of the Buddy Watch server 146 in FIG. 16. The packets are recovered by the cell transceiver, sent to the central switching system 102 and routed from there to gateway 148 where they are routed over wide area network 147 to the Buddy Watch server (step 156).
- 3) Buddy Watch server authenticates the initiator and the recipient from data in the packet as a Buddy Watch subscribers. If either is not a Buddy Watch subscriber, the server blocks the transaction by not forwarding the packets to the recipient. Assuming both are subscribers, the server forwards the Instant Buddy request packets to the recipient's wireless device and these packets get routed in the cell system (step 160) via the gateway, central switching system and cell transceiver of the cell in which the recipient's wireless device is registered.
- 4) The proposed Instant Buddy's wireless device receives the packets and displays an Instant Buddy Request screen (step 164) like that shown at 171 in FIG. 19 (step 162). This screen shows the phone number, Instant Buddy ID and Screen ID of the Initiator so the recipient knows who has requested the Instant Buddy relationship. The recipient can either accept or deny the relationship using commands displayed at 173 and 175.
- 5) If the Instant Buddy relationship is accepted (step 166), processing proceeds to step 168 where an accepted packet is sent back to the initiator's wireless device. If the Instant Buddy relationship is denied, step 170 sends a denied packet back to the Initiator device and the process is over (step 172) save for a display on the Initiator device that the Instant Buddy relationship has been denied.

14

6) When the accepted packet arrives at the Initiator device, the device shows an Instant Buddy accepted screen as shown at 177 in FIG. 19 (step 174). This screen shows the phone number, Instant Buddy ID and Screen ID of the recipient and provides commands to accept or cancel the relationship at fields 179 and 181.

- 7) If the Initiator accepts the Instant Buddy relationship (step 176), step 178 occurs where an accepted packet is sent back to the Recipient through the Buddy Watch server.
- 8) The Buddy Watch server records the existence of the new Instant Buddy relationship (step 180), and both wireless devices start sending their GPS position data in packets addressed to the Buddy Watch server. The Buddy Watch server stores the position data from each wireless device and forwards the packets to the other device for updating of their displays. In the preferred embodiment, the Buddy Watch server pulls an appropriate map from the MapQuest server 149 in FIG. 16 based upon the GPS position data of the Initiator and sends that map and the GPS position data in packets addressed to the Recipient. The Buddy Watch server then pulls an appropriate map from the MapQuest server based upon the Recipient's position, and sends that map and the Recipient's GPS position to the Initiator. Each wireless device then displays the position of the other Instant Buddy on the map provided by the Buddy Watch server.

An alternative Instant Buddy setup process is described next:

- 1) A call from one wireless device to another is initiated;
- 2) After agreeing to establish an Instant Buddy relationship, the initiator clicks on the Instant Buddy menu option;
- 3) This causes an Instant Buddy Setup screen to be shown on the initiator's device which has a first field which is auto-filled with the initiator's phone number, a second field which is auto-filled with an Instant Buddy ID, and a third field which is auto-filled with a Screen ID for the Instant Buddy (this screen ID is a three digit number which will be displayed with the position of the Instant Buddy and is shorter than the Instant Buddy ID);
- 4) The initiator fills in a timeout period for the Instant Buddy relationship or accepts the default value of midnight and clicks a Next command;
- 5) The recipient's wireless device receives the instant buddy request and displays an Instant Buddy Request screen that shows the initiator's phone number, Instant Buddy ID and Screen ID and displays an accept or deny command;
- 6) The recipient either accepts or denies the Instant Buddy relationship;
- 7) If the recipient accepts the Instant Buddy relationship, this fact is communicated to the initiator's wireless device which then displays a screen which displays the recipient's phone number and the recipient's Instant Buddy ID and his or her Screen ID and displays an accept or deny command which the initiator can click on;
- 8) If the initiator selects the accept command, both wireless devices start exchanging GPS position data, but they do not if the initiator decides to deny the Instant Buddy relationship.

FIG. 22 is a flowchart of the preferred embodiment for the instant buddy setup process. The initiator selects the instant buddy setup process—250, and enters the phone of the proposed new instant buddy—252. The initiator fills in timeout period—254, and instant buddy packets get routed to the Rubicon (Buddy Watch) server through the cell system—256. Rubicon server authenticates the initiator and recipient and forwards packets to cell system—258. The cell system routes packets to the cell where the proposed new instant buddy

15

is—260, and the proposed instant buddy receives a message on her wireless device and displays the instant buddy request screen—262. The instant buddy sees the initiator buddy ID, screen ID and, optionally, his phone number—264, and accepts or denies the relationship—266, 270, 272. If accepted, a packet is sent back to the initiator's wireless device—268, which causes the initiator's device to show an Instant Buddy accept screen with the recipient's phone number, buddy ID and screen ID which the initiator must OK to establish the relationship—274. Steps 276, 278 and 280 handle the acceptance or rejection. In 282, if accepted, the Rubicon server records the new instant buddy relationship and both wireless devices start sharing location information with the Rubicon (X One) server where it is stored and forwarded to the other Instant Buddy. In 284, the initiator's device shows the Instant Buddy Accept screen. Steps 286, 288 verify the phone is collecting GPS data using the GPS sampler program.

User Interface Displays for Buddy Lists

FIG. 3 represents a display in the user interface which shows individuals on the phone's Buddy List as well as a group of buddies which has been given the name Tennis Team. In all the user interface screen shots in the figures of this patent application, a cross hatched area indicates an active status and is typically colored green on the phone display. For example, each cross hatched buddy in column 14 indicates that that buddy's location sharing is active and his position can be seen if the user clicks on that buddy using whatever navigation or pointing mechanism that is built into the cell phone user interface.

The Buddy Tracker software also has the ability to set up instant buddies with, for example, tow truck drivers. Display area 16 shows an instant buddy entry for an instant buddy named Inst01. For example, the user's car breaks down. The user calls a towing service, and finds out the tow truck driver has a cell phone with Buddy Tracker on it. The user dials the tow truck driver's cell phone and requests to be an instant buddy of the tow truck driver's phone. His phone is then set up as an instant buddy on the user's phone. After both phones are set up as instant buddies, each phone shows the location of the other phone on its moving map. This allows the tow truck driver to find the user tow truck customer and the user customer to know where the tow truck driver is.

FIG. 4 shows another user interface display that results from selecting the tennis team entry 18 on the Buddy List of FIG. 4 and then clicking on the Tracie entry. When the Tracie entry is clicked, the information in column 20 appears showing her full name, position, the time of her last fix, her distance from the user and her speed. A green status (cross hatched) means a buddy has his phone on with location sharing turned on and the phone is within range. A yellow status for a buddy (stippled) means the buddy was active and had his location sharing turned on, but contact with him has been lost for one reason or another. A darker green status (double cross hatched), means the buddy is active and has his location sharing turned on but he is out of the immediate area that can easily be shown on the phone's map display. For example, suppose most of the tennis team group are in the Northern California area, but one member of the group is in Los Angeles. If the member in Los Angeles has his phone turned on with location sharing on, his entry in the tennis team list will be shown as dark green meaning his position cannot be mapped.

The Mapit function shown at 22 in FIG. 4 is a function that can be invoked to map the location of Tracie Saka on the phone's display. If Tracie is within range, and the Mapit function is clicked, a display such as the one shown in FIG. 5

16

is rendered on the phone's display showing the general area and showing Tracie's position at 24 with a text box 26 superimposed on the map with Tracie's name rendered therein.

FIG. 6 is a user interface display showing a map rendering with the location history of a selected member of the tennis team rendered thereon. This display is rendered when the Mapit with History function 28 in FIG. 4 is selected. This display shows the path Tracie took to get to her current location by way of waypoints 30, 31, 32 and 33. In some embodiments, when a user wishes to record a waypoint for their current position, a command can be given that causes the current position of the phone to be reported and saved as a waypoint on the Buddy Watch server 146 in FIG. 16.

In other embodiments, a particular position such as the phones current position or a position selected by moving crosshairs on a map display on a phone can be sent as a meeting place to all buddies on a Buddy List. When such a command is given and a Buddy List is selected, the position of the meeting place and the designated Buddy List is put into packets addressed to the Buddy Watch server 146 and transmitted thereto where the information is stored. The meeting position is then packetized in packets addressed to all the buddies of the designated Buddy List, and those packets are addressed to the phones of the buddies on the designated Buddy List and sent thereto.

Referring to FIG. 7, there is shown a display of a screen showing positions and status of members of a selected group. In this example, Tracie and Karen's positions are known and their name boxes in the left column are displayed in some color such as green indicating they are within cellular coverage and their positions are known. On the other hand, Dean's name box is shown in some other distinctive color such as yellow (represented by single cross hatch) to indicate contact with Dean has been lost. This happens when a user travels outside cellular coverage. Because Dean's name box is currently selected by the cursor, the settings column has the last known information about Dean also displayed in the distinctive color and represented by a single cross hatch. These boxes show Dean's last known position fix time (box 34), his full name (box 36), his last known distance (box 38), and his last known direction, latitude, longitude and speed (boxes 40, 42, 44 and 46, respectively).

FIG. 8 is a screen display showing what is displayed when Dean is selected and the Mapit command in box 48 is given by double clicking on the box or by any other means. When this Mapit command is given, Dean's last known position is displayed with a circle of a distinctive color (such as red), as illustrated at 50.

Instant Buddy Display with Mapit Position Mapping

An instant buddy relationship also allows the location of the motorist, lost or injured hiker or other user to appear on the tow truck or ambulance driver's cell phone Mapit display.

FIG. 9 is an instant buddy display showing the instant buddy position. This display can be selected after an instant buddy relationship has been set up. This display shows the ID of the instant buddy in box 52, the time of the last position fix in box 54, the distance to the instant buddy in box 56. The direction to the instant buddy, latitude and longitude and speed of the instant buddy are shown in boxes 58, 60, 62 and 64, respectively. If the user selects the Mapit command in box 66 or the Mapit with history command in box 68, the phone display will change to a display like that shown in FIG. 8 or FIG. 6, respectively, with the current position of the instant buddy shown and the prior positions shown if the history option is selected.

Alternative Instant Buddy Setup Process: To set up an instant buddy relationship, the phone is given a command to

17

display an instant buddy setup screen like that shown in FIG. 10. The display of FIG. 10 is used to establish an instant buddy ID in box 70, give the instant buddy a caller ID in box 72 (the instant buddy's caller ID or phone number is used by default). Box 74 is used to establish a timeout period at the end of which the instant buddy relationship is automatically terminated. The timeout period can be set to any interval in some embodiments, or to some selected interval from a drop down menu. Box 76 is used to establish the carrier the instant buddy is using. A cancel command is shown at 78 and a request command is shown at 80.

To start the instant buddy relationship, the request command is issued after the other boxes are filled in. Typically, a stranded motorist or hiker will call a tow truck or 911 and get the caller ID and carrier of the tow truck driver or rescuer. The stranded motorist or hiker will then enter this information in boxes 72 and 76. Box 70 shows an instant buddy ID which is automatically assigned by the system. After entering the information, the request command shown at 80 is selected. The screen of the rescuer's phone will then change to the display shown in FIG. 11. The information the requester filled in on the FIG. 10 screen will appear in boxes 82, 84, 86 and 88 on the stranded motorist or hiker's phone as well as on the instant buddy's phone (the tow truck or 911 rescuer). Commands for Denied and Accepted will also appear at 90 and 92 of the instant buddy's phone. If the instant buddy desires to accept the instant buddy relationship, he or she selects the accept command, and the tracking of the two instant buddies' positions will begin. Upon acceptance of the instant buddy relationship, each instant buddy's phone displays changes to the display shown in FIG. 9 from which the Mapit or Mapit with history command can be issued.

Corporate Supervision Setup Via Passcode

Corporations that wish to monitor the locations of their employees can use the system of the invention by using a corporate passcode. In this mode of operations, corporate employees are set up as a group with their supervisor as one member of the group. Each employee in the group can have his own buddies but he cannot delete the supervisor from the group. Only the supervisor can delete himself from the group of each employee's phone since only the supervisor has the passcode to change the group's members to delete himself. In one embodiment, the location information sharing is unidirectional from employees to supervisor but each employee can see the location of other employees on their phones but not the location of the supervisor. In this embodiment, the location sharing can be configured to be on only during working hours Monday to Friday. In other embodiments, the employees can see the locations of the supervisor as well as the locations of the other employees.

Timed Updates

The teachings of the invention contemplate doing position updates periodically at configurable intervals as well as a configuration option to do periodic updates as well as an update every x miles if a buddy in a group being monitored moves more than x miles between periodic updates. In some embodiments, the velocity at which a Buddy is moving or the amount of distance since the last update a Buddy has moved controls the frequency of the updates. Timed updates are handy for parents to monitor the positions of their children to make sure they do not move more than X miles from their home base. Position updates can be requested by a member of a Buddy List for position updates from the Buddy Watch server. The server receives positions reports from all the Buddy Watch phones registered with it and stores them and knows the Buddy Lists for each phone. When a request for a position update is received, positions of all the buddies on

18

Buddy Lists of which that phone is a part will be transmitted as packets addressed to all the phones on all the Buddy Lists of which the requester is a part. In alternative embodiments, the position updates will be sent for all members of all Buddy Lists of which the requesting phone is a part, but will only be sent to the requesting phone to avoid excess network traffic. In other alternative embodiments, the requesting phone can designate a particular member of a particular Buddy List and request an update only for the position of the designated buddy. The position update will be sent only to the requesting phone.

Follow Me Mode

In some applications such as construction sites with large construction crews and one supervisor, it is useful for everybody working on the job to be able to find the supervisor but the supervisor does not care where anybody else is. In embodiments with this capability, the supervisor turns on the Follow Me mode, typically making a menu selection. This causes the supervisor's position to be reported to the Buddy Watch server on a regular basis in packets that have information in their headers or elsewhere which indicate they are Follow Me packets and which designates to which Buddy List this information is pertinent. The Buddy Watch server takes these position updates and packetizes them into packets addressed to each of the phones on the designated Buddy List and sends those packets to the Buddy List phones. Position updates from the phones on the Buddy List are not sent to the supervisor phone or any of the other phones on the Buddy List.

This Follow Me mode can also be done in a blind code mode. This means that the supervisor does not need to list everyone on his buddy list. This is an "open channel" mode. Any "follower" who wants to track the position of the supervisor only needs to list the supervisor's name and phone number on a buddy list of the "follower" phone. The supervisor enters a blind code in the Follow Me mode, and this code is published to all phones that have Buddy Watch software. This blind code entry and publication allows any follower to enter the blind code in a buddy list on the follower phone and thereafter to receive the supervisor's position reports. This entry of the blind code will give any follower the ability to receive position reports from the supervisor's phone, and the supervisor will not have to approve each buddy individually. This can be a great convenience since on some job sites, there may be hundreds or thousands of workers. The follower phone sends a packet to the Buddy Watch server telling it that the follower phone is in the Follow Me mode for the particular supervisor. This causes the Buddy Watch server to send position reports it receives from the supervisor phone to the follower phone, but the server does not send position reports from the follower phone to the supervisor phone. The follower phone does not send position reports to the Buddy Watch server when in the Follow Me mode. Disabling, removing or changing the blind code, stops Follow Me mode.

Buddies Only Mode

The Buddies only mode differs from the All On Follow Me mode and the Blind Code Buddies modes in that position reports are only received from Buddies on a specifically named Buddy List with specifically named Buddies. No blind code Buddies or Instant Buddy position reports can be received in this mode.

Waypoint Store Mode

This mode is useful for parents to monitor the travels of their children. In this mode, the child's phone periodically reports the child's position, and the parent can have the position reports sent to his phone (or computer in some embodiments). In some embodiments, position alert data can be

configured to send an alarm signal to a parent if a child's position gets too close to a specified location or too far from the home location or some other location.

Request Update

This mode allows a specific user to request an update on the position of a specific Buddy. The requesting phone sends a request packet to the Buddy Watch server identifying itself and requesting a position update on a specified Buddy. The Buddy phone need not do anything other than do its normal operation of sending position updates to the Buddy Watch server. The update request causes the Buddy Watch server to provide a two-way update so that the requesting phone's location is sent by the Buddy Watch server to the Buddy phone and the Buddy phone's location is sent by the Buddy Watch server to the requesting phone. If the requester is part of a group, then the Buddy phone's location is sent to all phones in the group.

Timed Update

In this mode, periodic updates from the phone of a person such as a child or other person being cared for can be periodically sent to a list of parental or other supervisor destinations such as the parent's cell phone or email address. The sender phone may also be configured to send its location periodically to all others on a list. Updates on position can be every 15 minutes or some other configurable interval. In addition, each supervisorial user can request an update and the updates will be sent to every phone on the supervisorial list. If a phone on the list is not available, the update will indicate that no update is available, change the display to yellow and the status to unavailable but keep displaying the last way point.

Personal Bread Crumbs

This is an emergency feature which allows tracking down children or elderly people who are no longer responding to inquiries sent to their phone. This mode is useful for children who do not want to be watched but want a safety line to their friends and family in case something happens. A user who wishes to use this feature sets up their profile such that the Buddy Watch server checks in with them via their Buddy Watch enabled phone on a daily basis to determine if all is OK. The user must enter their secret code to confirm that all is OK. The phone prompts them to enter this code, and a certain number of prompts can be ignored before the system raises any alarms.

FIGS. 20A and 20B are a flowchart of one embodiment of the process of enabling the personal bread crumbs mode and how it works. Step 200 represents the process of enabling this mode. Typically, this is done by the user in selecting a menu command, but in some embodiments, it may be permanently configured to be on by the phone manufacturer. When this mode is enabled, the phone stores waypoints of the position of the holder of the phone periodically (step 202). The phone does not send the waypoints to anybody, but it does send data or a message to the Buddy Watch server that the personal bread crumbs feature has been enabled (step 204), so the Buddy Watch server starts a timer (step 206). The purpose of starting this timer is to establish intervals at the end of which an "Are you OK?" message will be sent to the phone which is in Personal Bread Crumbs™ mode.

Step 208 represents the process of monitoring the timer for a timeout event. This may take the form of a hardware or software interrupt. When a timeout occurs, the Buddy Watch server sends an inquiry to the phone inquiring if the user is OK (step 210). The phone then displays the "Are you OK?" message, and the user either enters his or her secret code to say they are OK or does not. If the user does not respond, processing proceeds back to step 206 to start the timer again as

the user may simply be busy, have their phone off, be asleep, etc. However, after a configurable number of attempts to establish contact with no response, step 216 will conclude that the user may be in trouble and need rescue. In that case, processing is vectored by step 216 to step 218. In step 218, the phone is commanded by the Buddy Watch server to send distress messages out to predetermined phone numbers (five in the preferred embodiment) and/or email addresses. The voice mail message may indicate to check email for details. The email contains a content of a position report file that contains all the waypoints since the last OK was received. If there are no stored waypoints, at least one set of stored waypoints previously recorded are sent. The waypoints all provide latitude, longitude, date and time of recording.

The personal bread crumbs profile includes:

- 1) a list of emails to which messages should be sent;
- 2) a list of phone numbers to which the prerecorded voicemails are to be sent;
- 3) frequency of OK confirmation the user needs to agree to (default is daily at noon);
- 4) the text of an email to describe the emergency situation to readers which should include the mobile phone number, home phone number, work phone number, home address and other pertinent information; and
- 5) whether or not auto attachment of waypoints to emails is to be carried out.

In an alternative embodiment, step 218 represents the Buddy Watch server itself sending out the distress messages. In some embodiments, the distress messages are prerecorded voicemail messages which indicate the user may be in trouble and giving instructions to the recipient how to retrieve the position reports from the Buddy Watch server. Step 218 also represents the process of the phone sending its GPS position waypoints to the Buddy Watch server. In some embodiments, the prerecorded voicemails are sent to pre-determined phone numbers and the predetermined emails are sent to predetermined email addresses and include the GPS position reports in the text of the message. The email messages at least will include the personal breadcrumb position reports. These messages indicate to the recipients that there may be trouble and that they should start looking for the person who owns the phone.

FIG. 21 is a flowchart of another embodiment of a process to establish and use personal bread crumbs mode. In step 201, the user enables the bread crumbs mode, and in step 203 the mobile phone contacts the Buddy Watch server (also called the Rubicon server herein) and informs it that personal bread crumbs mode is on. GPS sample data is collected (205) and the server is contacted to start the "Are you OK" timeout interval (207). Timeout causes the phone to display an "Are you OK" message (209). Steps 211 and 213 handle the situation where the user does not enter a secret code and retries. Step 215 represents the Rubicon server response if the user does not respond to the "Are you OK" message properly and timely, said response involving sending whatever distress messages are set up in the preferences file. GPS location samples and timestamps are included in the distress messages (217) and the messages are sent to the users listed in the preferences file (219).

Relational Database Compatibility

The Buddy Watch server is configured and programmed to be compatible with business applications where the customer may desire to find individuals based upon their capabilities, certifications or the equipment they are carrying. By making the Buddy Watch fields of the Buddy Watch database available for search and/or integration into other business databases, a company such as a service based organization can

determine which individuals have the proper certification to work on a specific problem and/or who have the appropriate tools and where those individuals are located relative to a site to which the company wishes them to be dispatched. The Buddy Watch server is programmed to provide information about the subscribers and their locations in a format which is compatible with the other business database structures of customers who are interested in having this data. Each position update received by the Buddy Watch server then is exported and automatically updates the customer database. This can be done over the Internet or over a dedicated local area or wide area network.

Radar Inclusion

The radar inclusion mode is a mode which allows police departments or fire departments or any other emergency response type organizations to instantly expand their buddy lists to predetermined lists of all available personnel. This is useful when it is necessary to know the whereabouts of persons to assist in an emergency situation or other situation. This feature may be used by police or other groups where the formation of a group may vary throughout the day. This feature can be used in conjunction with standard groups. How this feature differs is that a user does not need to be identified and only when the user comes within the "radar" range or radius does the user get included within the radar inclusion group.

City, County, State or Federal law enforcement or other agencies can offer two capabilities with radar inclusion. The first capability is to send an alert with a fixed target or to add a moving target to any individuals or groups without any input from the field officers. The target could be a suspect on the move. The target affords all the officers a better view of what is going on. The second capability allows the agency using the radar inclusion feature to "light up" the positions of other individuals or groups of individuals on a Mapit display so that one or more officers/firemen responding to an emergency can see the positions of possible reinforcements relative to their position. This is useful when groups that normally do not work together such as perhaps the fire and police need to work together. Details about each Buddy which is lit up on the Mapit display can be sent to any other Buddy in need thereof by a command to the Buddy Watch server issued by the controlling personnel of the agency.

In the instant messaging protocol packets transmitted from a phone to the Buddy Watch server, there is a field that can be left blank or a prefix can be put in. An agency using radar inclusion can put a code in this field and then all Buddy Watch phones/PDAs operating in radar inclusion mode are sent these packets and retain the Buddy whose information is in the packets in a group. This new group can be retained for a user programmable time up to 24 hours beyond the radar inclusion Buddy display disappearing.

The Buddy Watch server determines if a matching radar code is in range of a user and is not currently part of their active buddy list. If not they are added if the radar inclusion mode is active.

Split Groups

When a member of a group specified by a Buddy in that group for Mapit display is outside the radius set up in a Group Map Size configuration entry, then that member is split from the group and will not appear on the map of the group. However, that member which has been split from the group will have an entry in a distinctive color such as dark green on the list of active users in the group. Changing the Group Map Size configuration entry to a larger size may allow the split member to be displayed. If the location of the split member must be viewed but the Group Map Size is not to be changed,

clicking on the member of the group which has been split from the Buddy List will cause the Mapit display to change to the locale of the split member and display the member's location on the map so long as the split member's Buddy Watch status is active.

Power Off or Disable Buddy Tracker

When the phone is turned off or the Buddy Tracker application is disabled, a final transmission to the Buddy Watch server of the location of the Buddy is made. The Buddy Watch server distributes this location in packets addressed to all the members of the group of the Buddy who just went to inactive status.

Targets

The Buddy Tracker software allows targets to be designated to specify meeting points, sites of emergencies or service call locations. Law enforcement agencies can use this feature to silently redirect personnel to the site of a crime or emergency without broadcasting the location on the radio for persons using police scanners to hear. Each target can have a user defined label associated with it and a message, photo(s) or other document(s) can be attached to the target. All the data defining the target, any label associated therewith and any photos or other documents is packetized in packets identifying the data therein as target data or attachments to the target. These packets are received by the Buddy Watch server and re-packetized addressed to all members of a group or a radar inclusion group or specific Buddies.

A target can be specified by any member of a group or by a dispatcher of a law-enforcement or other agency. Targets can be specified using a web browser. The target is a forward looking waypoint. This can be useful if groups are to meet at a predefined location and the first to arrive may find this is either not the right location or for some reason the meeting point should be changed. The target can be moved, and then packets containing the data of the new target location are sent by the Buddy Watch server to all members of the group with an alert message indicating the target has moved. Targets can be moved simply by dragging and dropping the target to a new location on the display on the web browser which is logged into the Buddy Watch server and which has invoked the target specification command. Once the target has been initially set, moving it to a new location creates a waypoint history. Each target can have a description associated with it, and if the target has been moved, the history can be viewed.

Out of Coverage Operation

When devices are out of cellular coverage, some limited operations are still possible based on the device. For devices with a full GPS receiver, the user can set targets or force waypoints that are stored. Each device may differ based on the amount of available memory.

If a Buddy takes his phone into areas of intermittent coverage, it offers a means of some contact. Additionally, one may visit a site on a rural road or other location out of coverage. Setting a target or forcing a waypoint from a phone or desktop computer which is not located at the target provides the location, but does not provide any idea regarding what is at the location. A picture phone at the location can capture a picture of the location, and this picture be associated with the target to give other Buddies in the group some idea of what to expect when they get to a meeting point or target.

When a user wants to return to the site, the saved target can be recalled and sent to other Buddies in a group or individually designated so a return trip can be planned. This provides the ability to return to spots not located on roads or at intersections such as pastoral settings.

Local maps when out of coverage would not show up on the user's phone when the Mapit command is issued. This is

because the map pixels are sent from the Buddy Watch server to the phone after being retrieved from a mapping server such as Yahoo maps. When the phone is out of coverage, the map pixel packets cannot reach the phone and it cannot render a map. However, if the phone has a GPS receiver, it can store the point the user indicated he would like to capture, and, later when the phone is back in coverage, it can send the GPS location to the Buddy Watch server in a Mapit command packet, and get the map pixels back from the Buddy Watch server along with any attachments.

Phones with limited memory will decrease the frequency of position updates so as to not exceed the memory capacity. Attachments to Targets and Waypoints

Attachments such as photos can be appended to targets and waypoints even with travelling outside a coverage area. Once the phone is back in coverage, the attachment to a waypoint for example will be sent to the Buddy Watch server and can be distributed to other users. Documents created with phone apps or pictures captured by the phone's built in camera can be attached, and, if the phone has a USB port, pictures captured by a digital camera or camcorder can be imported and attached.

Encryption of Data

The Buddy Watch software application is disabled and encrypted when it is downloaded to prevent other unauthorized users from installing and using it. The Buddy Watch application program is decrypted and enabled when the access code is downloaded after a subscription is purchased since the decryption key is or is part of or is encoded into the access code.

Access Codes

Access codes to enable the Buddy Watch application are designed to incorporate the phone number or phone serial number as part of the encryption key so that the access code can only enable one phone. Large groups with many phones, can ask for and receive access codes that allow operation across a large number of phones.

Access codes are downloaded to the phone from the cell provider's server or emailed to the user when the user provides their name, phone number, phone serial number and a form of payment. The application may be downloaded to a MAC or PC, and then configured on the personal computer before being uploaded to the phone by a computer-to-phone USB connection.

Targets

A member of a buddy group can market a target on a Mapit display, and that target location can be shared to all the members of the group and show up on their Mapit displays so they all know where to meet. Marking targets is done using cursors on the Mapit display on the phone. The user then designates the buddy list to which the marked target is to be published. Packets are generated in the Buddy Watch application on the phone which include the GPS location, any name assigned to the target and the identification of the buddy list to which the location is to be published. These packets are sent to the Buddy Watch server which then extracts the data and packetizes it into packets addressed to all the phones on the designated buddy list. These packets are then sent to the buddies on the list and the location of the target is extracted and posted on a Mapit display.

User Waypoints

The users can mark particular waypoints as they travel using the Mapit displays on their phones, and pictures or memos can be attached to these waypoints. In one embodiment, this is done by sending a packet with the location marked by the user to the Buddy Watch server and in that packet giving an identifier or pointer that will be contained in

other packets which record the memo or photo to be attached to the waypoint. The Buddy Watch server then extracts the data from these packets and stores the user waypoint location with a pointer to the file in which the memo or photo is stored.

5 SOS Support

Each user of Buddy Watch can define a profile of buddies to which an SOS alert is to be sent in the case of emergency. The SOS alert message includes location, time and phone number (caller ID) and a preset message for email or Instant Message service and a prerecorded voice message. This data is sent in packets addressed to the Buddy Watch server when the user gives a command to send the SOS message. The Buddy Watch server then receives the SOS message, determines who it is from, retrieves the SOS profile stored on the server for that user and generates packets for email and IM and sends them on the internet and generates packets containing the digitized voice message and addresses them to the phones listed in the SOS profile and sends those packets to the cellular system central switching system 102 in FIG. 16 via internet gateway 148.

The SOS message protocol can be carried out by the Buddy Watch server either on demand from the user, or automatically in conjunction with any 911 call made from a phone which has a stored SOS profile. The SOS support configuration file contains data which defines which way the phone will act, and the buddies receiving the SOS messages will be aware of whether an 911 call was made or not. The buddies are actually in a better condition to help the caller since they can see the caller's position on their Mapit displays, and they may be closer to the caller and be able to act quicker than the 911 support personnel.

The preferred embodiment causes the SOS messages to be sent when the user dials **911**. A **411** dialed call will send the SOS messages to only active buddies whose phones are registered in the system and on with Buddy Watch activated.

The User Interface Genus

All species within the genus of user interfaces according to the teachings of the invention will display buddy lists and a list of buddies on each buddy list when that buddy list is selected. All species will display the specific information about a buddy when a particular buddy is selected including at least their current location and the time of the fix. All species will display a command or icon or menu choice that can be invoked to allow a user to turn off location sharing. All species will display commands, icons or menu choices to add, delete or edit buddy lists, or to add or delete or edit buddies.

Some species within this genus will also display one or more of the following items of information about individual buddies: speed, last contact, altitude or direction. Some species within the genus will provide icons, menu choices, etc. which a user can invoke to allow the user to select a map display with the location of a buddy displayed thereon. Some species within the genus will allow a user to give a command to request historical fixes which trace a path to the buddy's current position. Some species within the genus will allow instant buddy relationships to be set up to allow location sharing between a person in trouble and a rescuer.

The Server Genus

All servers programmed with Buddy Watch software will have functionality to:

1. either store map data for entire geographical areas that they serve or to obtain pertinent map data from another server such as a Mapquest™ server and pick the appropriate maplet that surrounds the positions of buddies to be displayed and serve the maplet data to Buddy Watch enabled phones;

25

2. pick the appropriate maplet for each buddy list or buddy based upon the center of gravity of the buddy positions of the buddies within the selected buddy list and exclude buddies which are out of the coverage area;
3. render buddy locations on maplets based upon GPS location data gathered from Buddy Watch applications running on GPS enabled cell phones and PDAs;
4. store user defined data that embodies each user's buddy lists and buddies and configuration data;
5. store at least some preference data that defines who can use the server, e.g. only those with a valid Buddy Watch user ID and password);
6. request and receive update and regularly scheduled GPS location data from users who have their Buddy Watch application turned on their phones or PDAs and to distribute location data and maplets to the phones and PDAs of the buddies on buddy lists who have their Buddy Watch capability turned on; and
7. turn Buddy Watch functionality on or off in terms of receiving location data from users who have indicated they want their Buddy Watch application turned off and turn off sharing location data of buddies who have turned off their Buddy Watch application.

Various species within this genus: can calculate the center of gravity of the best fit for the maximum number of buddies that are within the coverage of one maplet; determine the proper maplet size to send to the client phone or PDA based upon configuration data which defines the screen size of the device; send the same size maplet to all clients; allow each client to determine its own maplet size; send maplets with buddies color coded to show who is out of bounds and who is in lost contact status; implement a permissive buddy list wherein a person cannot be added to a buddy list until they consent; implement timed updates for GPS position and scheduled cutoff times for position sharing; store auxiliary information about each buddy such as phone numbers, etc.; offer the functionality to allow each user to specify the maplet size they receive or specify a maximum maplet size for a buddy list; offer the functionality to request updates whenever a programmable delta time or delta position difference over the last update occurs; offer a user preference to turn on or turn off GPS position updates; the ability to cross communicate with other carrier's cellular systems to send maplets to and receive location data from users on other systems; function to enable or disable the Buddy Watch application without disabling location sharing with parental or supervisor units; storing as a preference or configuration data SOS emails and voicemail messages which can be sent out to email addresses and/or phone numbers specified in a configuration data file on demand or automatically when a 911 call is made.

The Client Application Genus

The client Buddy Watch application and phone or PDA platform genus collectively provide the following functionality:

1. the programmed phone or PDA must be able to retrieve GPS position data directly or indirectly from a GPS receiver in the phone or PDA, and it should be able to wirelessly send the GPS position data to the Buddy Watch server either periodically or on demand from the server, but one or another, it must be able to exchange position information data with the server;
2. the phone or PDA must have a display large enough to display maplets and be able to download maplets from the Buddy Watch server;
3. it must have Java or similar software to exchange digital data with the Buddy Watch server using a wireless web application program;

26

4. it must be able to communicate with the phone's application programmatic interface and any application programmatic interface of the cell phone service provider to:
 - be able to receive maplets from the Buddy Watch server with location data rendered thereon and display the maplets;
 - send location data and receive downstream messages and requests from the Buddy Watch server.

An important species with this genus will be able to request software needed to execute commands given by the user from the Buddy Watch server, receive a download of the software requested, install it into random access memory and execute it to carry out the requested command. In other species, the software Apparatus and Process are to simplify Push to Talk walkie-talkie operations in cell phones.

FIG. 31 is a block diagram of the system for TalkControl to simplify cell phone walkie-talkie operations. Block 300 is a location determination component which functions to determine user locations. This can be done in the cell phones or the Rubicon server and provides a generic solution to extract location from GPS, J2ME location API or bespoke development for extracting Cell ID. If done on the server, the GMLC based solution is used. Block 300 also does distance calculations, location format conversion etc. LDG can expose a LIF based interface to location based services when applicable. This provides location determination flexibility as needed.

SBC component 302 functions to do buddy group/list management, mapping techniques, refresh based upon time or delta movement, geo coding, reverse geo coding, routing, etc.

CMC block 304 functions to provide local content to location based services. The content can be local maps or commercial/enterprise specific content. Multiple parties like commercial content providers, government establishments or enterprises will provide the content. This CMC component will provide a common API to extract content from multiple providers and provide the flexibility to choose any content provider based upon parameters such as accuracy, availability of content, rates, whether the content is the latest, etc.

The SRC block 306 is a software rendering component which provides multiple channel and device rendering, mobile application provisioning, service creation environment, OSS/BSS integration in both pre-paid and post paid modes, usage analysis reports and SNMP based system management software.

GSC block 308 provides alert and notification systems, personalization, payment integration etc.

Individual services block 310 provides tools and generic components to build individual applications in consumer and enterprise domains. Consumer services like child tracking, buddy location, location based advertisements for target user groups can be built. Enterprise services such as work force management, fleet tracking, emergency services, etc. can use the generic components.

FIG. 32 is a flow diagram of a process a user of a walkie-talkie enabled phone can initiate to join a talk group to enable subsequent walkie-talkie operations. This process greatly simplifies the process of signing up for walkie-talkie operations of a wireless carrier. A user who wishes to join a walkie-talkie talk group launches the TalkControl application, scrolls down to Join Group menu option, selects an Enter Tokens option, fills in her name, phone number, project ID, and Token and presses send. One or more packets are sent to the Rubicon server which authenticates the token and the recipient and creates a database entry. The Rubicon server then determines a time to add the user to the talk group and contacts a server of the wireless carrier to add a user. The Rubicon server logs

27

onto the Carrier Server and adds the user to the appropriate talk group and receives a confirmation. The confirmation is sent to the user who initiated the process, and the Rubicon server logs out of the carrier server.

FIG. 33 is a flowchart of the process the Rubicon server carries out to automatically delete a user. Users in talk groups can be deleted automatically based upon a scheduled deletion time using this process. The Rubicon (X One) server compares the current date and time with a database for users scheduled to be deleted. If a user is to be deleted per schedule, the Rubicon server logs onto a carrier server and deletes the user from the appropriate talk group and receives confirmation. The Rubicon server then deletes the user from the talk group in its database and logs out of the carrier server. The Rubicon server then sends the deletion confirmation to the user phone.

FIG. 34 is a flowchart of the process the Rubicon server carries out to allow a supervisor to add a user. The supervisor launches the TalkControl application program and scrolls down to the add/edit/delete user menu option and logs in as a supervisor and presses send. The supervisor then selects User Name and selects Next to take him to the user screen where the user's name, phone number, and project ID are entered. The supervisor then edits the start date, end date, hours, days of the week for the active period when the user being added will be part of the talk group so that walkie-talkie service can only be had during the specified times. One or more packets are then generated addressed to the Rubicon server and encapsulated in a cellular system packet and sent. These packets get routed to the Rubicon server which authenticates the initiator and recipient, creates a database entry for the user and contacts the Carrier server and logs on. The Rubicon server then adds the user to the appropriate talk group and receives confirmation. The Rubicon server then adds the user to the appropriate talk group and updates its database and receives the confirmation. The confirmation is sent to the supervisor who added the user and to the user phone which was added to the talk group.

FIG. 35 is a flowchart of the process for a supervisor to edit a user in a talk group. The supervisor launches the TalkControl application and scrolls down to add/edit/delete user and selects that option. The supervisor logs in as the supervisor and selects edit user and selects a user already in a talk group and edits data in fields for name, phone number, project ID of the user to be edited and presses next. Start date, end date, hours, days of the week are then changed as desired. From that point, the process is the same as adding a new user.

FIG. 36 is a flowchart of a process for a supervisor to delete a user from a talk group. The supervisor launches TalkControl and scrolls down to add/edit/delete user and selects that. She logs in as a supervisor and scrolls down to delete a user and deletes data in name, phone number, project ID, start date, end date, hours and days of week field and presses send. One or more packets get routed to the Rubicon servers which authenticates the initiator and recipient. The Rubicon server then logs onto the Carrier server and deletes the user from the appropriate talk group and receives a confirmation. The Rubicon server receives the confirmation and updates its database to delete the user from a talk group. Confirmation is then sent from the Rubicon server to the supervisor phone and the user's phone, and the Rubicon server then logs out of the carrier server.

FIG. 37 is a flowchart of a process for a supervisor to issue a token. The supervisor launches TalkControl and scrolls down to add/edit/delete a user. She logs in as a supervisor and scrolls down to issue token menu option and selects it. She then scrolls down to select project to issue token menu option

28

and presses next. The user selects token being issued and presses issue. The supervisor then informs the user of the project name and the token code. Packets are sent to the Rubicon server which removes the token from the list and replaces it with a new token. The Rubicon server then sends a message to the supervisor's phone to add the message send new token to the supervisor's handset.

FIG. 38 is a flowchart for the process of setting up preferences. The TalkControl application is launched on the handset and the user scrolls down to the add/edit/delete user option and presses select. The user logs in and presses send. The user then scrolls down to preferences and presses next. The user then selects the preference feature to be updated and presses select. This vectors processing to one of the four illustrated lines of processing to set the methods of notification as audio, vibrate or select auto login or set the new password or set a new ID. Processing then loops back to allow another preference to be selected and edited.

FIG. 39 is a flowchart for the process to allow a supervisor to request status. The supervisor launches TalkControl and scrolls down to view status. She logs in as a supervisor and presses send and then selects a user. The supervisor then scrolls and selects project to view status and presses next and scrolls down to select the project and the user and views the user's details.

FIG. 40 is a process flowchart of the process for a supervisor to create a group. The supervisor launches TalkControl application and scrolls down to create a group and presses select. She then logs in as supervisor and presses send and enters group name. A talk group is then automatically created. The supervisor sets the duration of the group, its start date, end date, days, hours and presses next. One or more packets addressed to the Rubicon server are then created and sent to the Rubicon server. The Rubicon server then authenticates the initiator and recipient and creates a database entry for a new group. The Rubicon server then contacts the carrier server and logs in and creates a talk group in the carrier server and receives a confirmation. The Rubicon server then adds the group to the appropriate talk group and receives confirmation. The confirmation is then sent from the Rubicon server to the supervisor and the Rubicon server logs out of the carrier server. The supervisor phone then receives a message on the wireless device displaying the group added profile updated request screen.

Although the invention has been disclosed in terms of the preferred and alternative embodiments disclosed herein, those skilled in the art will appreciate possible alternative embodiments and other modifications to the teachings disclosed herein which do not depart from the spirit and scope of the invention. All such alternative embodiments and other modifications are intended to be included within the scope of the claims appended hereto.

What is claimed is:

1. A method of sharing position data between a first device associated with a first user and a second device associated with a second user, the position data including first position data indicating a first location of the first device and second position data indicating a second location of the second device, the method comprising:

receiving, from the first device, a first request to set up a position-sharing relationship between the first and second users;
transmitting a second request to the second device, the second request inviting the second user to accept the position-sharing relationship;
receiving a message from the second device indicating acceptance of the position-sharing relationship;

establishing the position-sharing relationship responsive to the acceptance;
 transmitting the first position data to the second device and the second position data to the first device;
 receiving updated first position data from the first device and updated second position data from the second device; and
 transmitting the updated first position data to the second device and the updated second position data to the first device;
 wherein the second user is one of multiple buddies of the first user, each buddy being associated with a corresponding mobile device, including the second device, the method further comprising:
 noting position data for each of the mobile devices, including the second position data;
 calculating a center of gravity for the position data; and displaying the position data for a subset of the buddies based on the center of gravity.
 2. The method of claim 1, further comprising:
 receiving a third request from one of the first device and the second device to calculate a path between the first position and the second position;
 calculating the path between the first position and the second position; and
 transmitting the calculated path to the one of the first device and the second device.
 3. The method of claim 1, wherein at least one of the devices is GPS-enabled.
 4. The method of claim 3, wherein the GPS-enabled device is a phone.
 5. The method of claim 4, further comprising issuing a location update request to the GPS-enabled phone.
 6. The method of claim 1, wherein the first request includes a timeout for terminating the position-sharing relationship, the method further comprising terminating the position-sharing relationship after the timeout.
 7. The method of claim 6, wherein the timeout specifies a default value.
 8. The method of claim 6, further comprising receiving the timeout from the first user at the first device.
 9. The method of claim 1, further comprising, responsive to a request from the first device, sending a maplet to the first device, the maplet centered on the second location.
 10. The method of claim 1 carried out on a server executing non-transitory computer-readable instructions.
 11. The method of claim 1, further comprising publishing the first and second position data to a third device associated with a third user.
 12. The method of claim 11, wherein the publishing depicts the first and second users on a map.
 13. The method of claim 12, wherein the publishing identifies a relationship between the third user and at least one of the first and second users.
 14. The method of claim 1, further comprising storing information indicative of a relationship between the first user and the second user.
 15. The method of claim 14, wherein the relationship is a buddy relationship.
 16. The method of claim 1, further comprising storing information designating a fixed or moving target, associating a label with the target, and transmitting the label to at least one of the first device and the second device.

17. The method of claim 1, further comprising storing information designating a fixed or moving target, associating a picture with the target, and transmitting the picture to at least one of the first device and the second device.
 18. The method of claim 1, further comprising storing information designating a fixed or moving target, associating a pointer to a camera file with the target, and transmitting content from the camera file to at least one of the first device and the second device.
 19. The method of claim 1, further comprising storing information designating a fixed or moving target, associating a message with the target, and transmitting the message to at least one of the first device and the second device.
 20. The method of claim 1, transmitting the first position data to the second device and the second position to the first device is responsive to position-update requests from the respective second device and first device.
 21. The method of claim 1, further comprising, after the second user accepts the position-sharing relationship, sending an alarm signal to the first device if the second device gets too close to, or too far from, a specified location.
 22. The method of claim 1, further comprising organizing the first and second users in a group of users, each of the users having a respective device, including the first device and the second device, and representing the group of users as a shape on a map encompassing the locations of the devices.
 23. The method of claim 22, further comprising sending an alert to at least one of the users in the group of one of the users leaves the group.
 24. The method of claim 1, further comprising defining a zone responsive to instructions from the first device and sending an alert to one or more devices when the first device enters or leaves the zone.
 25. The method of claim 24, wherein the zone may be used as a proximity room.
 26. The method of claim 24, where the zone is a circle with a user-determined radius.
 27. The method of claim 1, further comprising defining a zone by the first device and sending an alert to one or more devices when the second device enters or leaves the zone.
 28. The method of claim 1, further comprising, after the second user accepts the position-sharing relationship, communicating to the first device the time of the last fix of the second position data.
 29. The method of claim 28, further comprising communicating to the first device a distance of the second device from the first device.
 30. The method of claim 29, further comprising displaying via the first device a name of the second user, the time of the last fix, and the distance of the second device from the first device.
 31. The method of claim 30, further comprising displaying on the first device a position of the second device on a map.
 32. The method of claim 1, further comprising picking a maplet based on the center of gravity and displaying a location of each of the subset of the buddies on the maplet.
 33. The method of claim 1, further comprising relaying messages between the first and second users via the respective first and second devices during the position-sharing relationship.