



US009031581B1

(12) **United States Patent**  
**Haney**

(10) **Patent No.:** **US 9,031,581 B1**  
(45) **Date of Patent:** **May 12, 2015**

(54) **APPARATUS AND METHOD FOR OBTAINING CONTENT ON A CELLULAR WIRELESS DEVICE BASED ON PROXIMITY TO OTHER WIRELESS DEVICES**

(71) Applicant: **X One, Inc.**, Union City, CA (US)

(72) Inventor: **Richard D. Haney**, Union City, CA (US)

(73) Assignee: **X One, Inc.**, Union City, CA (US)

(\* ) Notice: Subject to any disclaimer, the term of this patent is extended or adjusted under 35 U.S.C. 154(b) by 0 days.

(21) Appl. No.: **14/536,512**

(22) Filed: **Nov. 7, 2014**

**Related U.S. Application Data**

(63) Continuation of application No. 14/139,695, filed on Dec. 23, 2013, which is a continuation of application No. 13/889,132, filed on May 7, 2013, now Pat. No. 8,798,593, which is a continuation of application No.

(Continued)

(51) **Int. Cl.**

**H04W 24/00** (2009.01)

**H04W 4/02** (2009.01)

(Continued)

(52) **U.S. Cl.**

CPC ..... **H04W 4/021** (2013.01); **H04W 64/00** (2013.01); **H04M 1/72519** (2013.01)

(58) **Field of Classification Search**

CPC ..... G06Q 30/02; G06Q 30/0255; G06Q 30/0267; G06Q 50/01; G06Q 20/40; G06Q 30/0261; H04W 4/02; H04W 4/025; H04W 4/206; H04W 4/023; H04W 4/04; H04W 4/185; H04W 8/16; H04L 67/22; H04L 67/24

See application file for complete search history.

(56) **References Cited**

U.S. PATENT DOCUMENTS

1,103,073 A 7/1914 O'Connell  
3,953,720 A 4/1976 Kelch

(Continued)

FOREIGN PATENT DOCUMENTS

AU 2003901617 4/2003  
AU 2003901795 4/2003

(Continued)

OTHER PUBLICATIONS

U.S. Appl. No. 60/046,020, filed May 9, 1997. First named inventor: Clayton R. Karmel. Entitled, "Positioning system using packet radio to provide differential global positioning satellite corrections and information relative to a position."

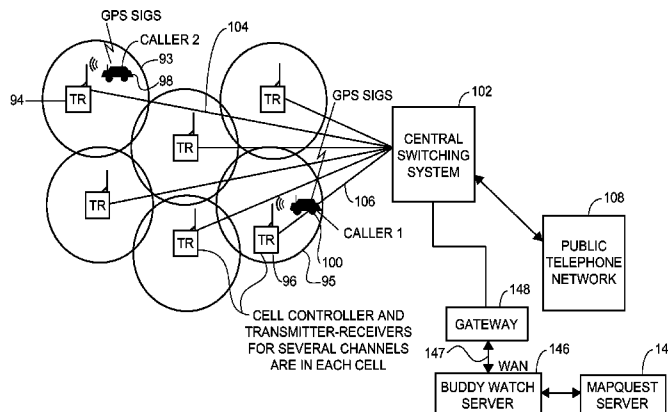
(Continued)

*Primary Examiner* — Kwasi Karikari

(57) **ABSTRACT**

A system for exchanging GPS or other position data between wireless devices for purposes of group activities, child location monitoring, work group coordination, dispatching of employees etc. Cell phones and other wireless devices with GPS receivers have loaded therein a Buddy Watch application and a TalkControl application. The Buddy Watch application communicates with the GPS receiver and other wireless devices operated by buddies registered in the users phone as part of buddy groups or individually. GPS position data and historical GPS position data can be exchanged between cell phones of buddies and instant buddies such as tow truck drivers via a buddy watch server. Emergency monitoring services can be set up with notifications to programmable individuals in case an individual does not respond. Positions and tracks can be displayed. TalkControl simplifies and automates the process of joining talk groups for walkie talkie services such as that provided by Nextel.

**22 Claims, 51 Drawing Sheets**



SERVER-BASED BUDDY WATCH SYSTEM

**Related U.S. Application Data**

12/075,408, filed on Mar. 11, 2008, now Pat. No. 8,538,458, which is a continuation of application No. 11/099,362, filed on Apr. 4, 2005, now Pat. No. 7,353,034.

- (51) **Int. Cl.**  
*H04W 64/00* (2009.01)  
*H04M 1/725* (2006.01)

(56) **References Cited**

U.S. PATENT DOCUMENTS

4,121,160 A	10/1978	Cataldo	5,223,844 A	6/1993	Mansell et al.
4,360,875 A	11/1982	Behnke	5,227,874 A	7/1993	Von Kohorn
4,445,118 A	4/1984	Taylor et al.	5,239,570 A	8/1993	Koster et al.
4,494,119 A	1/1985	Wimbush	5,243,652 A	9/1993	Teare et al.
4,606,073 A	8/1986	Moore	5,245,314 A	9/1993	Kah, Jr.
4,644,351 A	2/1987	Zabarsky et al.	5,249,044 A	9/1993	Von Kohorn
4,651,156 A	3/1987	Martinez	5,265,120 A	11/1993	Sanderford, Jr.
4,701,601 A	10/1987	Francini et al.	5,266,944 A	11/1993	Carroll et al.
4,706,275 A	11/1987	Kamil	5,274,560 A	12/1993	LaRue
4,736,196 A	4/1988	McMahon et al.	5,276,311 A	1/1994	Hennige
4,799,062 A	1/1989	Sanderford, Jr. et al.	5,283,570 A	2/1994	DeLuca et al.
4,818,998 A	4/1989	Apsell et al.	5,289,527 A	2/1994	Tiedemann, Jr.
4,819,860 A	4/1989	Hargrove et al.	5,289,572 A	2/1994	Yano et al.
4,868,376 A	9/1989	Lessin et al.	5,293,642 A	3/1994	Lo
4,884,132 A	11/1989	Morris et al.	5,295,064 A	3/1994	Malec et al.
4,891,638 A	1/1990	Davis	5,299,132 A	3/1994	Wortham
4,891,650 A	1/1990	Sheffer	5,301,354 A	4/1994	Schwendeman et al.
4,903,212 A	2/1990	Yokouchi et al.	5,303,297 A	4/1994	Hillis
4,907,159 A	3/1990	Mauge et al.	5,307,278 A	4/1994	Hermans et al.
4,910,767 A	3/1990	Brugliera et al.	5,311,516 A	5/1994	Kuznicki et al.
4,939,662 A	7/1990	Nimura et al.	5,317,311 A	5/1994	Martell et al.
4,952,928 A	8/1990	Carroll et al.	5,325,302 A	6/1994	Izidon et al.
4,972,484 A	11/1990	Theile et al.	5,327,529 A	7/1994	Fults et al.
4,980,913 A	12/1990	Skret	5,334,974 A	8/1994	Simms et al.
4,999,783 A	3/1991	Tenmoku et al.	5,335,246 A	8/1994	Yokey et al.
5,014,040 A	5/1991	Weaver et al.	5,337,044 A	8/1994	Folger et al.
5,014,206 A	5/1991	Scribner et al.	5,339,391 A	8/1994	Wroblewski et al.
5,021,794 A	6/1991	Lawrence	5,343,493 A	8/1994	Karimullah
5,031,104 A	7/1991	Ikeda et al.	5,347,568 A	9/1994	Moody et al.
5,039,980 A	8/1991	Aggers et al.	5,351,235 A	9/1994	Lahtinen
5,043,736 A	8/1991	Darnell et al.	5,361,212 A	11/1994	Class et al.
5,045,839 A	9/1991	Ellis et al.	5,363,425 A	11/1994	Mufi et al.
5,046,011 A	9/1991	Kakihara et al.	5,365,451 A	11/1994	Wang et al.
5,055,851 A	10/1991	Sheffer	5,371,678 A	12/1994	Nomura
5,067,081 A	11/1991	Person	5,374,933 A	12/1994	Kao
5,068,656 A	11/1991	Sutherland	5,374,936 A	12/1994	Feng
5,068,891 A	11/1991	Marshall	5,379,057 A	1/1995	Clough et al.
5,070,329 A	12/1991	Jasinaki	5,379,451 A	1/1995	Nakagoshi et al.
5,081,667 A	1/1992	Drori et al.	5,381,338 A	1/1995	Wysocki et al.
5,086,394 A	2/1992	Shapira	5,387,993 A	2/1995	Heller et al.
5,119,104 A	6/1992	Heller	5,388,147 A	2/1995	Grimes
5,119,396 A	6/1992	Sanderford, Jr.	5,390,125 A	2/1995	Sennott et al.
5,126,941 A	6/1992	Gurmu et al.	5,390,339 A	2/1995	Bruckert et al.
5,128,752 A	7/1992	Von Kohorn	5,394,158 A	2/1995	Chia
5,144,283 A	9/1992	Arens et al.	5,396,227 A	3/1995	Carroll et al.
5,153,584 A	10/1992	Engira	5,398,190 A	3/1995	Wortham
5,161,180 A	11/1992	Chavous	5,406,490 A	4/1995	Braegas
5,164,904 A	11/1992	Sumner	5,406,614 A	4/1995	Hara
5,166,972 A	11/1992	Smith	5,408,217 A	4/1995	Sanderford, Jr.
5,170,165 A	12/1992	Iihoshi et al.	5,412,388 A	5/1995	Attwood
5,173,691 A	12/1992	Sumner	5,414,432 A	5/1995	Penny, Jr. et al.
5,177,478 A	1/1993	Wagai et al.	5,416,712 A	5/1995	Geier et al.
5,177,479 A	1/1993	Cotton	5,416,890 A	5/1995	Beretta
5,182,555 A	1/1993	Sumner	5,418,537 A	5/1995	Bird
5,187,810 A	2/1993	Yoneyama et al.	5,422,813 A	6/1995	Schuchman et al.
5,193,215 A	3/1993	Olmer	5,423,076 A	6/1995	Westergren et al.
5,195,031 A	3/1993	Ordish	5,432,841 A	7/1995	Rimer
5,208,756 A	5/1993	Song	5,434,789 A	7/1995	Fraker et al.
5,208,763 A	5/1993	Hong et al.	5,438,321 A	8/1995	Bernard et al.
5,214,789 A	5/1993	George	5,442,557 A	8/1995	Kaneko
5,218,367 A	6/1993	Sheffer et al.	5,444,444 A	8/1995	Ross
5,218,629 A	6/1993	Dumond, Jr. et al.	5,444,450 A	8/1995	Olds et al.
			5,454,024 A	9/1995	Lebowitz
			5,457,689 A	10/1995	Marvit et al.
			5,457,713 A	10/1995	Sanderford, Jr. et al.
			5,461,365 A	10/1995	Schlager et al.
			5,461,390 A	10/1995	Hoshen
			5,469,362 A	11/1995	Hunt et al.
			5,470,233 A	11/1995	Fruchterman et al.
			5,479,408 A	12/1995	Will
			5,479,482 A	12/1995	Grimes
			5,479,600 A	12/1995	Wroblewski et al.
			5,485,161 A	1/1996	Vaughn
			5,485,163 A	1/1996	Singer et al.
			5,488,563 A	1/1996	Chazelle et al.
			5,497,149 A	3/1996	Fast
			5,504,482 A	4/1996	Schreder
			5,506,886 A	4/1996	Maine et al.
			5,508,707 A	4/1996	LeBlanc et al.

(56)

## References Cited

## U.S. PATENT DOCUMENTS

5,508,931 A	4/1996	Snider	5,661,755 A	8/1997	Van De Kerkhof et al.
5,510,801 A	4/1996	Engelbrecht et al.	5,663,732 A	9/1997	Stangeland et al.
5,512,879 A	4/1996	Stokes	5,666,215 A	9/1997	Fredlund et al.
5,513,243 A	4/1996	Kage	5,675,362 A	10/1997	Clough et al.
5,515,287 A	5/1996	Hakoyama et al.	5,677,837 A	10/1997	Reynolds
5,515,419 A	5/1996	Sheffer	5,682,525 A	10/1997	Bouve et al.
5,517,199 A	5/1996	DiMattei	5,682,600 A	10/1997	Salin
5,519,403 A	5/1996	Bickley et al.	5,684,859 A	11/1997	Chanroo et al.
5,519,760 A	5/1996	Borkowski et al.	5,689,245 A	11/1997	Noreen et al.
5,523,950 A	6/1996	Peterson	5,689,252 A	11/1997	Ayanoglu et al.
5,530,655 A	6/1996	Lokhoff et al.	5,689,270 A	11/1997	Kelley et al.
5,530,914 A	6/1996	McPheters	5,689,431 A	11/1997	Rudow et al.
5,532,690 A	7/1996	Hertel	5,697,058 A	12/1997	Paavonen
5,535,434 A	7/1996	Siddoway et al.	5,699,053 A	12/1997	Jonsson
5,537,460 A	7/1996	Holliday, Jr. et al.	5,699,244 A	12/1997	Clark, Jr. et al.
5,539,395 A	7/1996	Buss et al.	5,704,029 A	12/1997	Wright, Jr.
5,539,398 A	7/1996	Hall et al.	5,705,980 A	1/1998	Shapiro
5,539,647 A	7/1996	Shibata et al.	5,708,478 A	1/1998	Tognazzini
5,539,829 A	7/1996	Lokhoff et al.	5,712,619 A	1/1998	Simkin
5,539,924 A	7/1996	Grube et al.	5,712,679 A	1/1998	Coles
5,543,776 A	8/1996	L'Esperance et al.	5,712,899 A	1/1998	Pace, II
5,543,789 A	8/1996	Behr et al.	5,717,392 A	2/1998	Eldridge
5,546,445 A	8/1996	Dennison et al.	5,721,781 A	2/1998	Deo et al.
5,548,726 A	8/1996	Pettus	5,724,660 A	3/1998	Kauser et al.
5,552,772 A	9/1996	Janky et al.	5,727,057 A	3/1998	Emery et al.
5,552,989 A	9/1996	Bertrand	5,731,757 A	3/1998	Layson, Jr.
5,555,286 A	9/1996	Tendler	5,731,785 A	3/1998	Lemelson et al.
5,559,520 A	9/1996	Barzegar et al.	5,732,074 A	3/1998	Spaur et al.
5,559,707 A	9/1996	DeLorme et al.	5,732,354 A	3/1998	MacDonald
5,561,704 A	10/1996	Salimando	5,736,962 A	4/1998	Tendler
5,561,799 A	10/1996	Khalidi et al.	5,740,534 A	4/1998	Ayerst et al.
5,568,119 A	10/1996	Schipper et al.	5,740,549 A	4/1998	Reilly et al.
5,568,153 A	10/1996	Beliveau	5,742,233 A	4/1998	Hoffman et al.
5,570,412 A	10/1996	LeBlanc	5,742,509 A	4/1998	Goldberg et al.
5,574,648 A	11/1996	Pilley	5,742,635 A	4/1998	Sanderford, Jr.
5,574,772 A	11/1996	Scalisi et al.	5,742,666 A	4/1998	Alpert
5,579,372 A	11/1996	Åstrom	5,745,865 A	4/1998	Rostoker et al.
5,579,535 A	11/1996	Orlen et al.	5,748,109 A	5/1998	Kosaka et al.
5,588,009 A	12/1996	Will	5,752,186 A	5/1998	Malackowski et al.
5,590,396 A	12/1996	Henry	5,754,430 A	5/1998	Sawada
5,592,382 A	1/1997	Colley	5,754,939 A	5/1998	Herz et al.
5,592,535 A	1/1997	Klotz	5,758,049 A	5/1998	Johnson et al.
5,594,780 A	1/1997	Wiedeman et al.	5,758,257 A	5/1998	Herz et al.
5,598,572 A	1/1997	Tanikoshi et al.	RE35,829 E	6/1998	Sanderford, Jr.
5,604,486 A	2/1997	Lauro et al.	5,760,773 A	6/1998	Berman et al.
5,606,313 A	2/1997	Allen et al.	5,760,917 A	6/1998	Sheridan
5,606,618 A	2/1997	Lokhoff et al.	5,761,618 A	6/1998	Lynch et al.
5,606,850 A	3/1997	Nakamura	5,764,686 A	6/1998	Sanderford et al.
5,610,815 A	3/1997	Gudat et al.	5,765,152 A	6/1998	Erickson
5,614,890 A	3/1997	Fox	5,767,795 A	6/1998	Schaphorst
5,615,116 A	3/1997	Gudat et al.	5,768,509 A	6/1998	Gunluk
5,617,074 A	4/1997	White	5,771,353 A	6/1998	Eggleston et al.
5,619,571 A	4/1997	Sandstrom et al.	5,774,170 A	6/1998	Hite et al.
5,621,384 A	4/1997	Crimmins et al.	5,774,533 A	6/1998	Patel
5,621,793 A	4/1997	Bednarek et al.	5,774,670 A	6/1998	Montulli
5,627,547 A	5/1997	Ramaswamy et al.	5,774,824 A	6/1998	Streit et al.
5,627,548 A	5/1997	Woo et al.	5,774,829 A	6/1998	Cisneros et al.
5,627,549 A	5/1997	Park	5,777,580 A	7/1998	Janky et al.
5,628,050 A	5/1997	McGraw et al.	5,778,304 A	7/1998	Grube et al.
5,628,051 A	5/1997	Salin	5,787,357 A	7/1998	Salin
5,629,678 A	5/1997	Gargano et al.	5,793,630 A	8/1998	Theimer et al.
5,629,693 A	5/1997	Janky	5,794,142 A	8/1998	Vanttila et al.
5,630,206 A	5/1997	Urban et al.	5,796,365 A	8/1998	Lewis
5,633,912 A	5/1997	Tsoi	5,796,613 A	8/1998	Kato et al.
5,636,245 A	6/1997	Ernst et al.	5,797,094 A	8/1998	Houde et al.
5,636,276 A	6/1997	Brugger	5,797,096 A	8/1998	Lupien et al.
5,642,303 A	6/1997	Small et al.	5,798,732 A	8/1998	Eshenbach
5,646,853 A	7/1997	Takahashi et al.	5,802,492 A	9/1998	DeLorme et al.
5,646,992 A	7/1997	Subler et al.	5,805,460 A	9/1998	Greene et al.
5,650,770 A	7/1997	Schlager et al.	5,806,000 A	9/1998	Vo et al.
5,652,570 A	7/1997	Lepkofker	5,806,018 A	9/1998	Smith et al.
5,654,908 A	8/1997	Yokoyama	5,809,415 A	9/1998	Rossmann
5,655,013 A	8/1997	Gainsboro	5,812,086 A	9/1998	Bertiger et al.
5,661,460 A	8/1997	Sallen et al.	5,812,087 A	9/1998	Krasner
5,661,652 A	8/1997	Sprague et al.	5,822,700 A	10/1998	Hult et al.
			5,825,306 A	10/1998	Hiyokawa et al.
			5,825,884 A	10/1998	Zdepski et al.
			5,826,195 A	10/1998	Westerlage et al.
			5,828,740 A	10/1998	Khuc et al.

(56)

## References Cited

## U.S. PATENT DOCUMENTS

5,831,552 A	11/1998	Sogawa et al.	5,950,130 A	9/1999	Coursey
5,835,061 A	11/1998	Stewart	5,950,137 A	9/1999	Kim
5,835,376 A	11/1998	Smith et al.	5,953,398 A	9/1999	Hill
5,835,907 A	11/1998	Newman	5,953,706 A	9/1999	Patel
5,839,086 A	11/1998	Hirano	5,955,973 A	9/1999	Anderson
5,839,088 A	11/1998	Hancock et al.	5,959,577 A	9/1999	Fan et al.
5,841,396 A	11/1998	Krasner	5,959,580 A	9/1999	Maloney et al.
5,845,227 A	12/1998	Peterson	5,959,623 A	9/1999	van Hoff et al.
5,848,373 A	12/1998	DeLorme et al.	5,960,362 A	9/1999	Grob et al.
5,852,775 A	12/1998	Hidary	5,963,130 A	10/1999	Schlager et al.
5,854,793 A	12/1998	Dinkins	5,964,821 A	10/1999	Brunts et al.
5,857,201 A	1/1999	Wright, Jr. et al.	5,966,696 A	10/1999	Giraud
5,859,869 A	1/1999	Sanderford	5,968,109 A	10/1999	Israni et al.
5,862,244 A	1/1999	Kleiner et al.	5,969,678 A	10/1999	Stewart
5,864,667 A	1/1999	Barkan	5,974,054 A	10/1999	Couts et al.
5,867,110 A	2/1999	Naito et al.	5,978,685 A	11/1999	Laiho
5,870,686 A	2/1999	Monson	5,978,747 A	11/1999	Craport et al.
5,872,526 A	2/1999	Tognazzini	5,978,768 A	11/1999	McGovern et al.
5,873,068 A	2/1999	Beaumont et al.	5,982,281 A	11/1999	Layson, Jr.
5,874,914 A	2/1999	Krasner	5,982,298 A	11/1999	Lappenbusch et al.
5,883,580 A	3/1999	Briancon et al.	5,982,324 A	11/1999	Watters et al.
5,884,322 A	3/1999	Sidhu et al.	5,983,099 A	11/1999	Yao et al.
5,887,269 A	3/1999	Brunts et al.	5,987,323 A	11/1999	Huotari
5,890,064 A	3/1999	Widergen et al.	5,987,381 A	11/1999	Oshizawa
5,890,068 A	3/1999	Fattouche et al.	5,991,692 A	11/1999	Spencer, II et al.
5,892,454 A	4/1999	Schipper et al.	5,991,827 A	11/1999	Ellenby et al.
5,893,898 A	4/1999	Tanimoto	5,995,015 A	11/1999	DeTemple et al.
5,895,471 A	4/1999	King et al.	5,999,124 A	12/1999	Sheynblat
5,896,369 A	4/1999	Warsta et al.	5,999,126 A	12/1999	Ito
5,898,680 A	4/1999	Johnstone et al.	5,999,561 A	12/1999	Naden et al.
5,899,954 A	5/1999	Sato	6,002,393 A	12/1999	Hite et al.
5,905,248 A	5/1999	Russell et al.	6,002,932 A	12/1999	Kingdon et al.
5,905,451 A	5/1999	Sakashita	6,002,936 A	12/1999	Roel-Ng et al.
5,905,460 A	5/1999	Odagiri et al.	6,002,982 A	12/1999	Fry
5,908,465 A	6/1999	Ito et al.	6,004,061 A	12/1999	Manico et al.
5,910,799 A	6/1999	Carpenter et al.	6,005,928 A	12/1999	Johnson
5,913,040 A	6/1999	Rakavy et al.	6,006,159 A	12/1999	Schmier et al.
5,913,170 A	6/1999	Wortham	6,006,260 A	12/1999	Barrick, Jr. et al.
5,914,668 A	6/1999	Chavez, Jr. et al.	6,009,409 A	12/1999	Adler et al.
5,914,675 A	6/1999	Tognazzini	6,009,410 A	12/1999	LeMole et al.
5,915,243 A	6/1999	Smolen	6,014,090 A	1/2000	Rosen et al.
5,917,913 A	6/1999	Wang	6,014,602 A	1/2000	Kithil et al.
5,918,180 A	6/1999	Dimino	6,014,607 A	1/2000	Yagyu et al.
5,920,589 A	7/1999	Rouquette et al.	6,018,619 A	1/2000	Allard et al.
5,920,821 A	7/1999	Seazholtz et al.	6,018,718 A	1/2000	Walker et al.
5,922,074 A	7/1999	Richard et al.	6,023,653 A	2/2000	Ichimura et al.
5,923,861 A	7/1999	Bertram et al.	6,026,304 A	2/2000	Hilsenrath et al.
5,926,116 A	7/1999	Kitano et al.	6,026,370 A	2/2000	Jermyn
5,926,765 A	7/1999	Sasaki	6,026,375 A	2/2000	Hall et al.
5,930,250 A	7/1999	Klok et al.	6,028,514 A	2/2000	Lemelson et al.
5,930,474 A	7/1999	Dunworth et al.	6,028,550 A	2/2000	Froeberg et al.
5,930,699 A	7/1999	Bhatia	6,029,069 A	2/2000	Takaki
5,930,701 A	7/1999	Skog	6,031,490 A	2/2000	Forssen et al.
5,933,080 A	8/1999	Nojima	6,032,051 A	2/2000	Hall et al.
5,933,094 A	8/1999	Goss et al.	6,035,025 A	3/2000	Hanson
5,933,100 A	8/1999	Golding	6,038,295 A	3/2000	Mattes
5,933,811 A	8/1999	Angles et al.	6,041,280 A	3/2000	Kohli et al.
5,936,572 A	8/1999	Loomis et al.	6,044,403 A	3/2000	Gerszberg et al.
5,937,037 A	8/1999	Kamel et al.	6,047,236 A	4/2000	Hancock et al.
5,937,392 A	8/1999	Alberts	6,047,327 A	4/2000	Tso et al.
5,938,721 A	8/1999	Dussell et al.	6,049,710 A	4/2000	Nilsson
5,940,004 A	8/1999	Fulton	6,049,711 A	4/2000	Ben-Yehzekel et al.
5,940,834 A	8/1999	Pinard et al.	6,049,778 A	4/2000	Walker et al.
5,941,930 A	8/1999	Morimoto et al.	6,052,081 A	4/2000	Krasner
5,941,934 A	8/1999	Sato	6,052,122 A	4/2000	Sutcliffe et al.
5,943,399 A	8/1999	Bannister et al.	6,052,645 A	4/2000	Harada
5,945,944 A	8/1999	Krasner	6,055,434 A	4/2000	Seraj
5,946,618 A	8/1999	Agre et al.	6,058,300 A	5/2000	Hanson
5,946,626 A	8/1999	Foladare et al.	6,058,338 A	5/2000	Agashe et al.
5,946,629 A	8/1999	Sawyer et al.	6,058,350 A	5/2000	Ihara
5,946,630 A	8/1999	Willars et al.	6,061,018 A	5/2000	Sheynblat
5,946,646 A	8/1999	Schena et al.	6,061,346 A	5/2000	Nordman
5,948,040 A	9/1999	DeLorme et al.	6,061,681 A	5/2000	Collins
5,948,041 A	9/1999	Abo et al.	6,064,335 A	5/2000	Eschenbach
5,948,061 A	9/1999	Merriman et al.	6,064,336 A	5/2000	Krasner
			6,064,398 A	5/2000	Ellenby et al.
			6,064,875 A	5/2000	Morgan
			6,067,045 A	5/2000	Castelloe et al.
			6,067,502 A	5/2000	Hayashida et al.

(56)

## References Cited

## U.S. PATENT DOCUMENTS

6,069,570 A	5/2000	Herring	6,154,172 A	11/2000	Piccionelli et al.
6,070,067 A	5/2000	Nguyen et al.	6,154,658 A	11/2000	Caci
6,070,083 A	5/2000	Watters et al.	6,157,381 A	12/2000	Bates et al.
6,073,013 A	6/2000	Agre et al.	6,157,841 A	12/2000	Bolduc et al.
6,073,062 A	6/2000	Hoshino et al.	6,157,935 A	12/2000	Tran et al.
6,075,982 A	6/2000	Donovan et al.	6,163,749 A	12/2000	McDonough et al.
6,076,041 A	6/2000	Watanabe	6,166,627 A	12/2000	Reeley
6,078,818 A	6/2000	Kingdon et al.	6,167,266 A	12/2000	Havinis et al.
6,081,206 A	6/2000	Kielland	6,167,274 A	12/2000	Smith
6,081,229 A	6/2000	Soliman et al.	6,167,277 A	12/2000	Kawamoto
6,081,508 A	6/2000	West et al.	6,169,515 B1	1/2001	Mannings et al.
6,081,803 A	6/2000	Ashby et al.	6,169,552 B1	1/2001	Endo et al.
6,085,090 A	7/2000	Yee et al.	6,169,891 B1	1/2001	Gorham et al.
6,085,148 A	7/2000	Jamison et al.	6,169,901 B1	1/2001	Boucher
6,085,320 A	7/2000	Kaliski, Jr.	6,169,902 B1	1/2001	Kawamoto
6,087,965 A	7/2000	Murphy	6,173,181 B1	1/2001	Losh
6,088,040 A	7/2000	Oda et al.	6,175,740 B1	1/2001	Souissi et al.
6,088,594 A	7/2000	Kingdon et al.	6,175,922 B1	1/2001	Wang
6,088,722 A	7/2000	Herz et al.	6,177,905 B1	1/2001	Welch
6,091,956 A	7/2000	Hollenberg	6,177,938 B1	1/2001	Gould
6,091,957 A	7/2000	Larkins et al.	6,178,505 B1	1/2001	Schneider et al.
6,092,076 A	7/2000	McDonough et al.	6,178,506 B1	1/2001	Quick, Jr.
6,094,607 A	7/2000	Diesel	6,181,934 B1	1/2001	Havinis et al.
6,097,958 A	8/2000	Bergen	6,181,935 B1	1/2001	Gossman et al.
6,098,118 A	8/2000	Ellenby et al.	6,184,802 B1	2/2001	Lamb
6,100,806 A	8/2000	Gaukel	6,184,829 B1	2/2001	Stilp
6,101,378 A	8/2000	Barabash et al.	6,185,427 B1	2/2001	Krasner et al.
6,101,443 A	8/2000	Kato et al.	6,188,354 B1	2/2001	Soliman et al.
6,104,090 A	8/2000	Unger et al.	6,188,752 B1	2/2001	Lesley
6,104,931 A	8/2000	Havinis et al.	6,188,909 B1	2/2001	Alanara et al.
6,108,533 A	8/2000	Brohoff	6,188,959 B1	2/2001	Schupfner
6,108,555 A	8/2000	Maloney et al.	6,189,098 B1	2/2001	Kaliski, Jr.
6,108,709 A	8/2000	Shinomura et al.	6,195,557 B1	2/2001	Havinis et al.
6,111,541 A	8/2000	Karmel	6,195,609 B1	2/2001	Pilley et al.
6,111,911 A	8/2000	Sanderford, Jr. et al.	6,195,646 B1	2/2001	Grosh et al.
6,112,186 A	8/2000	Bergh et al.	6,198,390 B1	3/2001	Schlager et al.
6,113,649 A	9/2000	Govindaraj	6,198,431 B1	3/2001	Gibson
6,115,481 A	9/2000	Wiens	6,198,927 B1	3/2001	Wright et al.
6,115,611 A	9/2000	Kimoto et al.	6,199,014 B1	3/2001	Walker et al.
6,115,667 A	9/2000	Nakamura	6,199,045 B1	3/2001	Giniger et al.
6,115,680 A	9/2000	Coffee et al.	6,199,099 B1	3/2001	Gershman et al.
6,115,709 A	9/2000	Gilmour et al.	6,199,113 B1	3/2001	Alegre et al.
6,115,754 A	9/2000	Landgren	6,202,008 B1	3/2001	Beckert et al.
6,118,404 A	9/2000	Fernekes et al.	6,202,023 B1	3/2001	Hancock et al.
6,119,014 A	9/2000	Alperovich et al.	6,202,058 B1	3/2001	Rose et al.
6,119,098 A	9/2000	Guyot et al.	6,204,812 B1	3/2001	Fattouche
6,121,922 A	9/2000	Mohan	6,205,330 B1	3/2001	Winbladh
6,122,503 A	9/2000	Daly	6,208,290 B1	3/2001	Krasner
6,122,520 A	9/2000	Want et al.	6,208,297 B1	3/2001	Fattouche et al.
6,122,521 A	9/2000	Wilkinson et al.	6,208,854 B1	3/2001	Roberts et al.
6,123,259 A	9/2000	Ogasawara	6,208,857 B1	3/2001	Agre et al.
6,124,810 A	9/2000	Segal et al.	6,208,866 B1	3/2001	Rouhollahzadeh et al.
6,127,945 A	10/2000	Mura-Smith	6,208,934 B1	3/2001	Bechtolsheim et al.
6,128,482 A	10/2000	Nixon et al.	6,212,392 B1	4/2001	Fitch et al.
6,128,571 A	10/2000	Ito et al.	6,212,473 B1	4/2001	Stefan et al.
6,128,599 A	10/2000	Walker et al.	6,215,441 B1	4/2001	Moeglein et al.
6,131,028 A	10/2000	Whittington	6,216,086 B1	4/2001	Seymour et al.
6,131,067 A	10/2000	Girerd et al.	6,219,557 B1	4/2001	Havinis
6,133,874 A	10/2000	Krasner	6,222,483 B1	4/2001	Twitchell et al.
6,133,876 A	10/2000	Fullerton et al.	6,222,607 B1	4/2001	Szajewski et al.
6,134,483 A	10/2000	Vayanos et al.	6,222,939 B1	4/2001	Wiskott et al.
6,134,548 A	10/2000	Gottzman et al.	6,223,042 B1	4/2001	Raffel
6,138,003 A	10/2000	Kingdon et al.	6,223,046 B1	4/2001	Hamill-Keays et al.
6,138,142 A	10/2000	Linsk	6,223,122 B1	4/2001	Hancock et al.
6,140,957 A	10/2000	Wilson et al.	6,226,529 B1	5/2001	Bruno et al.
6,141,347 A	10/2000	Shaughnessy et al.	6,232,915 B1	5/2001	Dean et al.
6,144,336 A	11/2000	Preston et al.	6,233,430 B1	5/2001	Helferich
6,148,197 A	11/2000	Bridges et al.	6,233,518 B1	5/2001	Lee
6,148,198 A	11/2000	Anderson et al.	6,236,365 B1	5/2001	LeBlanc et al.
6,148,262 A	11/2000	Fry	6,236,933 B1	5/2001	Lang
6,149,353 A	11/2000	Nilsson	6,239,700 B1	5/2001	Hoffman et al.
6,150,980 A	11/2000	Krasner	6,239,742 B1	5/2001	Krasner
6,151,309 A	11/2000	Busuioc et al.	6,240,069 B1	5/2001	Alperovich et al.
6,151,498 A	11/2000	Roel-Ng et al.	6,240,360 B1	5/2001	Phelan
6,154,152 A	11/2000	Ito	6,240,425 B1	5/2001	Naughton
			6,243,039 B1	6/2001	Elliot
			6,243,588 B1	6/2001	Koorapaty et al.
			6,243,657 B1	6/2001	Tuck et al.
			6,246,376 B1	6/2001	Bork et al.

(56)

## References Cited

## U.S. PATENT DOCUMENTS

6,246,861 B1	6/2001	Messier et al.	6,330,452 B1	12/2001	Fattouche et al.
6,246,882 B1	6/2001	Lachance	6,330,454 B1	12/2001	Verdonk
6,246,948 B1	6/2001	Thakker	6,332,127 B1	12/2001	Bandera et al.
6,247,135 B1	6/2001	Feague	6,333,919 B2	12/2001	Gaffney
6,249,252 B1	6/2001	Dupray	6,339,437 B1	1/2002	Nielsen
6,249,282 B1	6/2001	Sutcliffe et al.	6,340,928 B1	1/2002	McCurdy
6,249,680 B1	6/2001	Wax et al.	6,341,255 B1	1/2002	Lapidot
6,249,742 B1	6/2001	Friederich et al.	6,343,317 B1	1/2002	Glorikian
6,249,744 B1	6/2001	Morita	6,345,288 B1	2/2002	Reed et al.
6,249,772 B1	6/2001	Walker et al.	6,347,230 B2	2/2002	Koshima et al.
6,249,783 B1	6/2001	Crone et al.	6,351,235 B1	2/2002	Stilp
6,249,873 B1	6/2001	Richard et al.	6,353,398 B1	3/2002	Amin et al.
6,252,543 B1	6/2001	Camp	6,353,743 B1	3/2002	Karmel
6,252,544 B1	6/2001	Hoffberg	6,353,837 B1	3/2002	Blumenau
6,253,091 B1	6/2001	Naddell et al.	6,356,192 B1	3/2002	Menard et al.
6,253,203 B1	6/2001	O'Flaherty et al.	6,356,543 B2	3/2002	Hall et al.
6,256,498 B1	7/2001	Ludwig	6,356,659 B1	3/2002	Wiskott et al.
6,259,405 B1	7/2001	Stewart et al.	6,356,761 B1	3/2002	Huttunen et al.
6,259,923 B1	7/2001	Lim et al.	6,356,763 B1	3/2002	Kangas et al.
6,260,147 B1	7/2001	Quick, Jr.	6,356,834 B2	3/2002	Hancock et al.
6,266,014 B1	7/2001	Fattouche et al.	6,356,836 B1	3/2002	Adolph
6,266,432 B1	7/2001	Wiens	6,356,838 B1	3/2002	Paul
6,266,612 B1	7/2001	Dussell et al.	6,356,905 B1	3/2002	Gershman et al.
6,266,614 B1	7/2001	Alumbaugh	6,359,557 B2	3/2002	Bilder
6,266,615 B1	7/2001	Jin	6,360,093 B1	3/2002	Ross et al.
6,269,343 B1	7/2001	Pallakoff	6,360,101 B1	3/2002	Irvin
6,272,231 B1	8/2001	Maurer et al.	6,360,102 B1	3/2002	Havinis et al.
6,272,342 B1	8/2001	Havinis et al.	6,360,164 B1	3/2002	Murayama
6,272,467 B1	8/2001	Durand et al.	6,363,254 B1	3/2002	Jones et al.
6,275,692 B1	8/2001	Skog	6,363,255 B1	3/2002	Kuwahara
6,275,849 B1	8/2001	Ludwig	6,366,568 B1	4/2002	Bolgiano et al.
6,278,701 B1	8/2001	Ayyagari et al.	6,367,019 B1	4/2002	Ansell et al.
6,278,884 B1	8/2001	Kim	6,367,037 B1	4/2002	Remer et al.
6,281,807 B1	8/2001	Kynast et al.	6,370,389 B1	4/2002	Isomursu et al.
6,282,491 B1	8/2001	Bochmann et al.	6,370,475 B1	4/2002	Breed et al.
6,282,496 B1	8/2001	Chowdhary	6,370,523 B1	4/2002	Anderson
6,286,005 B1	9/2001	Cannon	6,370,629 B1	4/2002	Hastings et al.
6,288,716 B1	9/2001	Humpleman et al.	6,373,430 B1	4/2002	Beason et al.
6,289,212 B1	9/2001	Stein et al.	6,374,176 B1	4/2002	Schmier et al.
6,289,373 B1	9/2001	Dezonne	6,377,179 B1	4/2002	Fulton
6,292,657 B1	9/2001	Laursen et al.	6,377,209 B1	4/2002	Krasner
6,292,671 B1	9/2001	Mansour	6,377,210 B1	4/2002	Moore
6,292,799 B1	9/2001	Peek et al.	6,377,793 B1	4/2002	Jenkins
6,295,454 B1	9/2001	Havinis et al.	6,377,810 B1	4/2002	Geiger et al.
6,295,502 B1	9/2001	Hancock et al.	6,377,886 B1	4/2002	Gotou et al.
6,297,768 B1	10/2001	Allen, Jr.	6,381,465 B1	4/2002	Chern et al.
6,298,306 B1	10/2001	Suarez et al.	6,381,539 B1	4/2002	Shimazu
6,300,903 B1	10/2001	Richards et al.	6,381,603 B1	4/2002	Chan et al.
6,301,370 B1	10/2001	Steffens et al.	6,385,458 B1	5/2002	Papadimitriou et al.
6,304,758 B1	10/2001	Iierbig et al.	6,385,465 B1	5/2002	Yoshioka
6,307,504 B1	10/2001	Sheynblat	6,385,535 B2	5/2002	Ohishi et al.
6,308,269 B2	10/2001	Proidl	6,385,541 B1	5/2002	Blumberg et al.
6,313,761 B1	11/2001	Shinada	6,385,622 B2	5/2002	Bouve et al.
6,313,786 B1	11/2001	Sheynblat et al.	6,388,612 B1	5/2002	Neher
6,314,365 B1	11/2001	Smith	6,389,288 B1	5/2002	Kuwahara et al.
6,314,369 B1	11/2001	Ito et al.	6,393,292 B1	5/2002	Lin
6,314,406 B1	11/2001	O'Hagan et al.	6,396,819 B1	5/2002	Fleeter et al.
6,317,029 B1	11/2001	Fleeter	6,397,040 B1	5/2002	Titmuss et al.
6,317,594 B1	11/2001	Gossman et al.	6,397,057 B1	5/2002	Malackowski et al.
6,317,604 B1	11/2001	Kovach, Jr. et al.	6,397,208 B1	5/2002	Lee
6,317,684 B1	11/2001	Roeseler et al.	6,397,219 B2	5/2002	Mills
6,317,718 B1	11/2001	Fano	6,400,270 B1	6/2002	Person
6,321,091 B1	11/2001	Holland	6,400,314 B1	6/2002	Krasner
6,321,092 B1	11/2001	Fitch et al.	6,400,320 B1	6/2002	Stilp et al.
6,321,158 B1	11/2001	DeLorme et al.	6,400,374 B2	6/2002	Lanier
6,321,250 B1	11/2001	Knape et al.	6,400,958 B1	6/2002	Isomursu et al.
6,321,257 B1	11/2001	Kotola et al.	6,401,032 B1	6/2002	Jamison et al.
6,323,846 B1	11/2001	Westerman et al.	6,401,034 B1	6/2002	Kaplan et al.
6,324,542 B1	11/2001	Wright, Jr. et al.	6,401,085 B1	6/2002	Gershman et al.
6,324,692 B1	11/2001	Fiske	6,404,388 B1	6/2002	Sollenberger et al.
6,326,918 B1	12/2001	Stewart	6,404,408 B1	6/2002	Emerson, III
6,327,473 B1	12/2001	Soliman et al.	6,405,034 B1	6/2002	Tijerino
6,327,479 B1	12/2001	Mikkola	6,405,037 B1	6/2002	Rossmann
6,327,573 B1	12/2001	Walker et al.	6,405,123 B1	6/2002	Rennard et al.
6,327,580 B1	12/2001	Pierce et al.	6,405,132 B1	6/2002	Breed et al.
			6,408,307 B1	6/2002	Semple et al.
			6,408,309 B1	6/2002	Agarwal
			6,411,254 B1	6/2002	Moeglein et al.
			6,411,899 B2	6/2002	Dussell et al.

(56)

## References Cited

## U.S. PATENT DOCUMENTS

6,414,629 B1	7/2002	Curcio	6,519,466 B2	2/2003	Pande et al.
6,414,635 B1	7/2002	Stewart et al.	6,519,771 B1	2/2003	Zenith
6,415,207 B1	7/2002	Jones	6,522,266 B1	2/2003	Soehren et al.
6,415,220 B1	7/2002	Kovacs	6,522,682 B1	2/2003	Kohli et al.
6,415,227 B1	7/2002	Lin	6,526,026 B1	2/2003	Menon
6,415,291 B2	7/2002	Bouve et al.	6,526,335 B1	2/2003	Treyz et al.
6,421,002 B2	7/2002	Krasner	6,526,352 B1	2/2003	Johnson et al.
6,421,669 B1	7/2002	Gilmour et al.	6,529,136 B2	3/2003	Cao et al.
6,424,840 B1	7/2002	Fitch et al.	6,529,143 B2	3/2003	Mikkola et al.
6,427,001 B1	7/2002	Contractor et al.	6,529,490 B1	3/2003	Oh et al.
6,427,115 B1	7/2002	Sekiyama	6,529,500 B1	3/2003	Pandharipande
6,427,120 B1	7/2002	Garin et al.	6,529,722 B1	3/2003	Heinrich et al.
6,430,409 B1	8/2002	Rossmann	6,529,829 B2	3/2003	Turetzky et al.
6,430,411 B1	8/2002	Lempio et al.	6,531,982 B1	3/2003	White et al.
6,430,496 B1	8/2002	Smith et al.	6,535,140 B1	3/2003	Goss et al.
6,433,734 B1	8/2002	Krasner	6,538,757 B1	3/2003	Sansone
6,434,381 B1	8/2002	Moore et al.	6,539,200 B1	3/2003	Schiff
6,434,530 B1	8/2002	Sloane et al.	6,539,232 B2	3/2003	Hendrey et al.
6,438,490 B2	8/2002	Ohta	6,539,304 B1	3/2003	Chansarkar
6,442,241 B1	8/2002	Tsumpes	6,539,424 B1	3/2003	Dutta
6,442,391 B1	8/2002	Johansson et al.	6,542,464 B1	4/2003	Takeda et al.
6,442,573 B1	8/2002	Schiller et al.	6,542,734 B1	4/2003	Abrol et al.
6,449,473 B1	9/2002	Raivisto	6,542,743 B1	4/2003	Soliman
6,449,476 B1	9/2002	Hutchison, IV et al.	6,542,748 B2	4/2003	Hendrey et al.
6,449,485 B1	9/2002	Anzil	6,542,749 B2	4/2003	Tanaka et al.
6,452,498 B2	9/2002	Stewart	6,542,750 B2	4/2003	Hendrey et al.
6,453,161 B1	9/2002	Touati et al.	6,542,812 B1	4/2003	Obradovich et al.
6,456,207 B1	9/2002	Yen	6,542,814 B2	4/2003	Polidi et al.
6,456,234 B1	9/2002	Johnson	6,542,819 B1	4/2003	Kovacs et al.
6,456,852 B2	9/2002	Bar et al.	6,546,360 B1	4/2003	Gilbert et al.
6,456,854 B1	9/2002	Chern et al.	6,549,522 B1	4/2003	Flynn
6,456,956 B1	9/2002	Xiong	6,549,625 B1	4/2003	Rautila et al.
6,459,782 B1	10/2002	Bedrosian et al.	6,549,768 B1	4/2003	Fraccaroli
6,459,913 B2	10/2002	Cloutier	6,549,776 B1	4/2003	Joong
6,462,675 B1	10/2002	Humphrey et al.	6,549,844 B1	4/2003	Egberts
6,463,142 B1	10/2002	Kilp	6,552,682 B1	4/2003	Fan
6,463,272 B1	10/2002	Wallace et al.	6,553,236 B1	4/2003	Dunko et al.
6,463,289 B1	10/2002	Havinis et al.	6,553,310 B1	4/2003	Lopke
6,466,695 B1	10/2002	Potzsch et al.	6,556,832 B1	4/2003	Soliman
6,469,664 B1	10/2002	Michaelson et al.	6,560,323 B2	5/2003	Gainsboro
6,473,031 B1	10/2002	Harris	6,560,456 B1	5/2003	Lohtia et al.
6,473,790 B1	10/2002	Tagi	6,560,461 B1	5/2003	Fomukong et al.
6,477,150 B1	11/2002	Maggenti et al.	6,560,534 B2	5/2003	Abraham et al.
6,477,363 B1	11/2002	Ayoub et al.	6,560,588 B1	5/2003	Minter
6,477,581 B1	11/2002	Carpenter et al.	6,563,430 B1	5/2003	Kemink et al.
6,480,147 B2	11/2002	Durst et al.	6,563,459 B2	5/2003	Takenaga
6,480,713 B2	11/2002	Jenkins	6,563,460 B2	5/2003	Stilp et al.
6,484,035 B2	11/2002	Allen, Jr.	6,563,950 B1	5/2003	Wiskott et al.
6,487,305 B2	11/2002	Kambe et al.	6,564,047 B1	5/2003	Steele et al.
6,487,495 B1	11/2002	Gale et al.	6,564,143 B1	5/2003	Alewine et al.
6,487,538 B1	11/2002	Gupta et al.	6,564,261 B1	5/2003	Gudjonsson et al.
6,490,454 B1	12/2002	Kangas et al.	6,567,068 B2	5/2003	Rekimoto
6,490,519 B1	12/2002	Lapidot et al.	6,570,530 B2	5/2003	Gaal et al.
6,490,698 B1	12/2002	Horvitz et al.	6,570,557 B1	5/2003	Westerman et al.
6,496,776 B1	12/2002	Blumberg et al.	6,571,095 B1	5/2003	Koodli
6,501,393 B1	12/2002	Richards et al.	6,571,279 B1	5/2003	Herz et al.
6,501,421 B1	12/2002	Dutta et al.	6,574,484 B1	6/2003	Carley
6,504,491 B1	1/2003	Christians	6,574,558 B2	6/2003	Kohli
6,504,503 B1	1/2003	Saint-Hilaire et al.	6,577,946 B2	6/2003	Myr
6,505,046 B1	1/2003	Baker	6,578,079 B1	6/2003	Gittins
6,505,048 B1	1/2003	Moles et al.	6,580,390 B1	6/2003	Hay
6,505,049 B1	1/2003	Dorenbosch	6,580,811 B2	6/2003	Maurer et al.
6,505,123 B1	1/2003	Root et al.	6,580,914 B1	6/2003	Smith
6,507,802 B1	1/2003	Payton et al.	6,581,072 B1	6/2003	Mathur et al.
6,509,830 B1	1/2003	Elliott	6,584,307 B1	6/2003	Antonucci et al.
6,510,387 B2	1/2003	Fuchs et al.	6,584,552 B1	6/2003	Kuno et al.
6,512,455 B2	1/2003	Finn et al.	6,587,688 B1	7/2003	Chambers et al.
6,512,922 B1	1/2003	Burg et al.	6,587,691 B1	7/2003	Granstam et al.
6,512,930 B2	1/2003	Sandegren	6,587,782 B1	7/2003	Nocek et al.
6,515,575 B1	2/2003	Kataoka	6,587,835 B1	7/2003	Treyz et al.
6,515,623 B2	2/2003	Johnson	6,590,533 B2	7/2003	Sollenberger et al.
6,516,197 B2	2/2003	Havinis et al.	6,591,103 B1	7/2003	Dunn et al.
6,518,889 B2	2/2003	Schlager et al.	6,591,190 B2	7/2003	Nishida et al.
6,519,241 B1	2/2003	Theimer	6,594,480 B1	7/2003	Montalvo et al.
6,519,463 B2	2/2003	Tendler	6,594,483 B2	7/2003	Nykanen et al.
			6,594,498 B1	7/2003	McKenna et al.
			6,594,500 B2	7/2003	Bender et al.
			6,594,576 B2	7/2003	Fan et al.
			6,594,691 B1	7/2003	McCollum et al.

(56)

## References Cited

## U.S. PATENT DOCUMENTS

6,597,305 B2	7/2003	Szeto et al.	6,681,107 B2	1/2004	Jenkins et al.
6,597,311 B2	7/2003	Sheynblat et al.	6,681,114 B2	1/2004	Chang et al.
6,597,983 B2	7/2003	Hancock	6,681,120 B1	1/2004	Kim
6,600,919 B1	7/2003	Kawase	6,683,538 B1	1/2004	Wilkes, Jr.
6,600,927 B2	7/2003	Hamilton et al.	6,684,087 B1	1/2004	Yu et al.
6,601,046 B1	7/2003	Epstein	6,684,250 B2	1/2004	Anderson et al.
6,601,060 B1	7/2003	Tomaru	6,684,269 B2	1/2004	Wagner
6,603,428 B2	8/2003	Stilp	6,687,360 B2	2/2004	Kung et al.
6,603,968 B2	8/2003	Anvekar et al.	6,687,504 B1	2/2004	Raith
6,603,973 B1	8/2003	Foladare et al.	6,687,608 B2	2/2004	Sugimoto et al.
6,606,495 B1	8/2003	Korpi et al.	6,687,734 B1	2/2004	Sellink et al.
6,606,554 B2	8/2003	Edge	6,690,268 B2	2/2004	Schofield et al.
6,608,556 B2	8/2003	De Moerloose et al.	6,690,322 B2	2/2004	Shamoto et al.
6,609,004 B1	8/2003	Morse et al.	6,691,114 B1	2/2004	Nakamura
6,609,062 B2	8/2003	Hancock	6,691,155 B2	2/2004	Gottfried
6,611,273 B2	8/2003	Stokes et al.	6,693,586 B1	2/2004	Walters et al.
6,611,498 B1	8/2003	Baker et al.	6,694,258 B2	2/2004	Johnson et al.
6,611,687 B1	8/2003	Clark et al.	6,694,352 B1	2/2004	Omoigui
6,611,751 B2	8/2003	Warren	6,694,387 B2	2/2004	Wagner
6,611,757 B2	8/2003	Brodie	6,697,018 B2	2/2004	Stewart
6,611,788 B1	8/2003	Hussa	6,697,629 B1	2/2004	Grilli et al.
6,615,131 B1	9/2003	Rennard et al.	6,697,730 B2	2/2004	Dickerson
6,615,134 B2	9/2003	Ando	6,697,731 B2	2/2004	Takayama et al.
6,615,213 B1	9/2003	Johnson	6,697,734 B1	2/2004	Suomela
6,618,593 B1	9/2003	Drutman et al.	6,698,020 B1	2/2004	Zigmond et al.
6,618,670 B1	9/2003	Chansarkar	6,700,534 B2	3/2004	Harris
6,618,822 B1	9/2003	Loaiza et al.	6,701,143 B1	3/2004	Dukach et al.
6,621,452 B2	9/2003	Knockeart et al.	6,701,144 B2	3/2004	Kirbas et al.
6,621,810 B1	9/2003	Leung	6,701,307 B2	3/2004	Himmelstein et al.
6,624,754 B1	9/2003	Hoffman et al.	6,703,971 B2	3/2004	Pande et al.
6,625,447 B1	9/2003	Rossmann	6,703,972 B2	3/2004	van Diggelen
6,625,457 B1	9/2003	Raith	6,704,651 B2	3/2004	van Diggelen
6,628,233 B2	9/2003	Knockeart et al.	6,707,421 B1	3/2004	Drury et al.
6,628,938 B1	9/2003	Rachabathuni et al.	6,707,581 B1	3/2004	Browning
6,629,104 B1	9/2003	Parulski et al.	6,711,408 B1	3/2004	Raith
6,629,136 B1	9/2003	Naidoo	6,711,474 B1	3/2004	Treyz et al.
6,633,255 B2	10/2003	Krasner	6,714,661 B2	3/2004	Buddenmeier et al.
6,633,763 B2	10/2003	Yoshioka	6,714,791 B2	3/2004	Friedman
6,639,516 B1	10/2003	Copley	6,714,793 B1	3/2004	Carey et al.
6,639,939 B1	10/2003	Naden et al.	6,714,797 B1	3/2004	Rautila
6,640,184 B1	10/2003	Rabe	6,718,174 B2	4/2004	Vayanos
6,647,257 B2	11/2003	Owensby	6,718,344 B2	4/2004	Hirono
6,647,269 B2	11/2003	Hendrey et al.	6,718,503 B1	4/2004	Lerner et al.
6,650,284 B1	11/2003	Mannings et al.	6,720,915 B2	4/2004	Sheynblat
6,650,288 B1	11/2003	Pitt et al.	6,720,920 B2	4/2004	Breed et al.
6,650,901 B1	11/2003	Schuster et al.	6,721,572 B1	4/2004	Smith et al.
6,650,902 B1	11/2003	Richton	6,721,578 B2	4/2004	Minear et al.
6,650,997 B2	11/2003	Funk	6,721,871 B2	4/2004	Piispanen et al.
6,650,998 B1	11/2003	Rutledge et al.	6,724,342 B2	4/2004	Bloebaum et al.
6,654,786 B1	11/2003	Fox et al.	6,724,382 B2	4/2004	Kenyon et al.
6,654,800 B1	11/2003	Rieger, III	6,725,159 B2	4/2004	Krasner
6,657,661 B1	12/2003	Cazier	6,728,701 B1	4/2004	Stoica
6,661,372 B1	12/2003	Girerd et al.	6,731,236 B1	5/2004	Hager et al.
6,661,409 B2	12/2003	Demartines et al.	6,731,238 B2	5/2004	Johnson
6,662,015 B2	12/2003	Furlong	6,731,612 B1	5/2004	Koss
6,662,016 B1	12/2003	Buckham et al.	6,731,940 B1	5/2004	Nagendran
6,662,023 B1	12/2003	Helle	6,732,120 B1	5/2004	Du
6,665,539 B2	12/2003	Sih et al.	6,734,821 B2	5/2004	van Diggelen
6,665,541 B1	12/2003	Krasner et al.	6,735,568 B1	5/2004	Buckwalter et al.
6,665,613 B2	12/2003	Duvall	6,735,585 B1	5/2004	Black et al.
6,665,715 B1	12/2003	Houri	6,735,630 B1	5/2004	Gelvin et al.
6,667,963 B1	12/2003	Rantalainen et al.	6,737,989 B2	5/2004	Flick
6,671,377 B1	12/2003	Havinis et al.	6,738,013 B2	5/2004	Orler et al.
6,671,620 B1	12/2003	Garin et al.	6,738,635 B1	5/2004	Lewis et al.
6,671,695 B2	12/2003	McFadden	6,738,800 B1	5/2004	Aquilon et al.
6,671,698 B2	12/2003	Pickett et al.	6,738,808 B1	5/2004	Enzmann et al.
6,674,849 B1	1/2004	Froeberg	6,741,188 B1	5/2004	Miller et al.
6,675,012 B2	1/2004	Gray	6,741,842 B2	5/2004	Goldberg et al.
6,675,014 B1	1/2004	Sundquist	6,741,926 B1	5/2004	Zhao et al.
6,677,894 B2	1/2004	Sheynblat et al.	6,744,856 B2	6/2004	Karnik et al.
6,677,968 B1	1/2004	Appelman	6,744,858 B1	6/2004	Ryan et al.
6,678,357 B2	1/2004	Stumer et al.	6,745,038 B2	6/2004	Callaway, Jr. et al.
6,678,516 B2	1/2004	Nordman et al.	6,747,556 B2	6/2004	Medema et al.
6,680,694 B1	1/2004	Knockeart et al.	6,747,596 B2	6/2004	Orler et al.
6,680,695 B2	1/2004	Turetzky et al.	6,748,195 B1	6/2004	Phillips
			6,748,225 B1	6/2004	Kepler
			6,748,226 B1	6/2004	Wortham
			6,748,318 B1	6/2004	Jones
			6,750,813 B2	6/2004	Vargas-Hurlston et al.



(56)

## References Cited

## U.S. PATENT DOCUMENTS

6,750,883 B1	6/2004	Parupudi et al.	6,813,560 B2	11/2004	van Diggelen et al.
6,751,464 B1	6/2004	Burg et al.	6,816,111 B2	11/2004	Krasner
6,751,626 B2	6/2004	Brown et al.	6,816,580 B2	11/2004	Timmins
6,754,636 B1	6/2004	Walker et al.	6,816,710 B2	11/2004	Krasner
6,754,904 B1	6/2004	Cooper et al.	6,816,719 B1	11/2004	Heinonen et al.
6,756,913 B1	6/2004	Ayed	6,816,734 B2	11/2004	Wong et al.
6,756,938 B2	6/2004	Zhao et al.	6,816,782 B1	11/2004	Walters et al.
6,757,156 B2	6/2004	Adams et al.	6,816,850 B2	11/2004	Culliss
6,757,517 B2	6/2004	Chang	6,819,267 B1	11/2004	Edmark et al.
6,757,544 B2	6/2004	Rangarajan et al.	6,819,301 B2	11/2004	Nagamatsu et al.
6,757,545 B2	6/2004	Nowak et al.	6,819,919 B1	11/2004	Tanaka
6,758,812 B2	7/2004	Lang	6,820,269 B2	11/2004	Baucke et al.
6,759,956 B2	7/2004	Menard et al.	6,823,188 B1	11/2004	Stern
6,759,960 B2	7/2004	Stewart	6,823,189 B2	11/2004	Akhteruzzaman et al.
6,762,772 B1	7/2004	Imamura et al.	6,823,257 B2	11/2004	Clapper
6,765,492 B2	7/2004	Harris	6,826,473 B1	11/2004	Burch et al.
6,765,998 B2	7/2004	Bruce et al.	6,826,598 B1	11/2004	Titmuss et al.
6,766,174 B1	7/2004	Kenyon	6,826,607 B1	11/2004	Gelvin et al.
6,766,245 B2	7/2004	Padmanabhan	6,828,908 B2	12/2004	Clark
6,768,944 B2	7/2004	Breed et al.	6,829,475 B1	12/2004	Lee et al.
6,769,002 B2	7/2004	Ayan	6,829,532 B2	12/2004	Obradovich et al.
6,771,742 B2	8/2004	McCalmont et al.	6,832,251 B1	12/2004	Gelvin et al.
6,771,970 B1	8/2004	Dan	6,832,373 B2	12/2004	O'Neill
6,771,971 B2	8/2004	Smith	6,834,115 B2	12/2004	Maurer et al.
6,772,213 B2	8/2004	Glorikian	6,834,195 B2	12/2004	Brandenberg et al.
6,772,340 B1	8/2004	Peinado et al.	6,839,020 B2	1/2005	Geier et al.
6,774,797 B2	8/2004	Freathy et al.	6,839,021 B2	1/2005	Sheynblat et al.
6,775,255 B1	8/2004	Roy	6,839,417 B2	1/2005	Weisman et al.
6,775,267 B1	8/2004	Kung et al.	6,839,561 B2	1/2005	Kato
6,775,534 B2	8/2004	Lindgren et al.	6,839,628 B1	1/2005	Tu
6,775,613 B2	8/2004	Burt et al.	6,842,620 B2	1/2005	Smith et al.
6,775,655 B1	8/2004	Peinado et al.	6,842,715 B1	1/2005	Gaal
6,775,802 B2	8/2004	Gaal	6,842,774 B1	1/2005	Piccioni
6,778,136 B2	8/2004	Gronemeyer	6,845,318 B1	1/2005	Moore et al.
6,778,524 B1	8/2004	Augart	6,845,400 B2	1/2005	Macpherson et al.
6,778,885 B2	8/2004	Agashe et al.	6,847,376 B2	1/2005	Engeldrum et al.
6,781,963 B2	8/2004	Crockett et al.	6,847,618 B2	1/2005	Laursen et al.
6,782,264 B2	8/2004	Anderson	6,847,822 B1	1/2005	Dennison et al.
6,782,278 B2	8/2004	Chen et al.	6,847,891 B2	1/2005	Pietras et al.
6,788,199 B2	9/2004	Crabtree et al.	6,847,969 B1	1/2005	Mathai et al.
6,788,249 B1	9/2004	Farmer et al.	6,848,542 B2	2/2005	Gailey et al.
6,788,288 B2	9/2004	Ano	6,850,188 B1	2/2005	Lee et al.
6,788,946 B2	9/2004	Winchell et al.	6,850,209 B2	2/2005	Mankins et al.
6,789,012 B1	9/2004	Childs et al.	6,850,837 B2	2/2005	Paulauskas et al.
6,789,102 B2	9/2004	Gotou et al.	6,853,332 B1	2/2005	Brookes
6,795,444 B1	9/2004	Vo et al.	6,853,911 B1	2/2005	Sakarya
6,795,686 B2	9/2004	Master et al.	6,853,916 B2	2/2005	Fuchs et al.
6,795,699 B1	9/2004	McCraw et al.	6,853,917 B2	2/2005	Miwa
6,795,700 B2	9/2004	Karaoguz et al.	6,853,955 B1	2/2005	Burrell et al.
6,795,710 B1	9/2004	Creemer	6,856,282 B2	2/2005	Mauro et al.
6,795,770 B1	9/2004	Hanshew et al.	6,859,149 B1	2/2005	Ohta et al.
6,798,358 B2	9/2004	Joyce et al.	6,859,721 B1	2/2005	Runquist et al.
6,799,032 B2	9/2004	McDonnell et al.	6,859,831 B1	2/2005	Gelvin et al.
6,799,049 B1	9/2004	Zellner et al.	6,861,980 B1	3/2005	Rowitch et al.
6,799,050 B1	9/2004	Krasner	6,865,171 B1	3/2005	Nilsson
6,801,159 B2	10/2004	Swope et al.	6,865,394 B2	3/2005	Ogino et al.
6,801,763 B2	10/2004	Elsey et al.	6,865,395 B2	3/2005	Riley
6,801,778 B2	10/2004	Koorapaty et al.	6,865,483 B1	3/2005	Cook, III et al.
6,801,850 B1	10/2004	Wolfson	6,867,733 B2	3/2005	Sandhu et al.
6,801,855 B1	10/2004	Walters et al.	6,867,734 B2	3/2005	Voor et al.
6,804,524 B1	10/2004	Vandermeijden	6,868,074 B1	3/2005	Hanson
6,804,657 B1	10/2004	Sultan	6,868,333 B2	3/2005	Melen
6,804,726 B1	10/2004	Ellenby et al.	6,868,396 B2	3/2005	Smith et al.
6,806,813 B1	10/2004	Cheng et al.	6,871,144 B1	3/2005	Lee
6,806,830 B2	10/2004	Panasik et al.	6,873,290 B2	3/2005	Anderson et al.
6,807,479 B2	10/2004	Watanabe et al.	6,873,850 B2	3/2005	Dowling et al.
6,807,534 B1	10/2004	Erickson	6,873,851 B2	3/2005	Brown et al.
6,810,323 B1	10/2004	Bullock et al.	6,873,854 B2	3/2005	Crockett et al.
6,812,851 B1	11/2004	Dukach et al.	6,876,734 B1	4/2005	Summers et al.
6,812,888 B2	11/2004	Drury et al.	6,879,244 B1	4/2005	Scalisi
6,813,264 B2	11/2004	Vassilovski	6,879,574 B2	4/2005	Naghian et al.
6,813,346 B2	11/2004	Gruchala et al.	6,879,835 B2	4/2005	Greene et al.
6,813,395 B1	11/2004	Kinjo	6,879,836 B2	4/2005	Nakamoto et al.
6,813,501 B2	11/2004	Kinnunen et al.	6,879,838 B2	4/2005	Rankin et al.
6,813,503 B1	11/2004	Zillikens et al.	6,882,313 B1	4/2005	Fan et al.
			6,882,348 B2	4/2005	Hirono
			6,882,850 B2	4/2005	McConnell et al.
			6,885,874 B2	4/2005	Grube et al.
			6,885,940 B2	4/2005	Brodie et al.

(56)

## References Cited

## U.S. PATENT DOCUMENTS

6,886,750 B2	5/2005	Rathus et al.	6,957,068 B2	10/2005	Hutchison, IV et al.
6,888,497 B2	5/2005	King et al.	6,957,072 B2	10/2005	Kangras et al.
6,888,536 B2	5/2005	Westerman et al.	6,957,073 B2	10/2005	Bye
6,888,932 B2	5/2005	Snip et al.	6,957,076 B2	10/2005	Hunzinger
6,891,500 B2	5/2005	Hall et al.	6,957,393 B2	10/2005	Fano et al.
6,895,238 B2	5/2005	Newell et al.	6,961,019 B1	11/2005	McConnell et al.
6,895,240 B2	5/2005	Laurson et al.	6,961,312 B2	11/2005	Kubler et al.
6,895,249 B2	5/2005	Gaal	6,961,562 B2	11/2005	Ross
6,898,416 B2	5/2005	Saarinan et al.	6,963,283 B1	11/2005	Gonzalez
6,898,436 B2	5/2005	Crockett et al.	6,963,557 B2	11/2005	Knox
6,898,516 B2	5/2005	Pechatnikov et al.	6,963,748 B2	11/2005	Chithambaram et al.
6,898,518 B2	5/2005	Padmanabhan	6,963,900 B2	11/2005	Boyd
6,898,526 B2	5/2005	Doyle et al.	6,965,754 B2	11/2005	King
6,900,758 B1	5/2005	Mann et al.	6,965,767 B2	11/2005	Maggenti et al.
6,901,260 B1	5/2005	Xin	6,965,816 B2	11/2005	Walker
6,901,304 B2	5/2005	Swan et al.	6,965,868 B1	11/2005	Bednarek
6,901,444 B1	5/2005	Brelin	6,968,044 B2	11/2005	Beason et al.
6,903,684 B1	6/2005	Simic et al.	6,968,179 B1	11/2005	De Vries
6,903,685 B1	6/2005	Arndt et al.	6,968,195 B2	11/2005	Nowak
6,904,029 B2	6/2005	Fors et al.	6,970,130 B1	11/2005	Walters et al.
6,904,360 B2	6/2005	Pechatnikov et al.	6,970,837 B1	11/2005	Walker et al.
6,904,364 B2	6/2005	Randazzo et al.	6,970,917 B1	11/2005	Kushwaha et al.
6,907,224 B2	6/2005	Younis	6,970,922 B1	11/2005	Spector
6,907,238 B2	6/2005	Leung	6,973,320 B2	12/2005	Brown et al.
6,909,902 B1	6/2005	Sawada et al.	6,973,384 B2	12/2005	Zhao et al.
6,912,230 B1	6/2005	Salkini et al.	6,975,266 B2	12/2005	Abraham et al.
6,912,395 B2	6/2005	Benes et al.	6,975,873 B1	12/2005	Banks et al.
6,912,398 B1	6/2005	Domnitz	6,975,874 B1	12/2005	Bates et al.
6,912,545 B1	6/2005	Lundy et al.	6,975,941 B1	12/2005	Lau et al.
6,914,626 B2	7/2005	Squibbs	6,975,959 B2	12/2005	Dietrich et al.
6,915,208 B2	7/2005	Garin et al.	6,978,258 B2	12/2005	Chithambaram
6,917,331 B2	7/2005	Gronemeyer	6,978,453 B2	12/2005	Rao et al.
6,917,703 B1	7/2005	Steffens et al.	6,980,813 B2	12/2005	Mohi et al.
6,917,878 B2	7/2005	Pechatnikov et al.	6,980,816 B2	12/2005	Rohles et al.
6,917,968 B2	7/2005	Nakamura	6,980,909 B2	12/2005	Root et al.
6,920,328 B2	7/2005	Wollrab	6,981,029 B1	12/2005	Menditto et al.
6,920,391 B2	7/2005	Daubert et al.	6,982,656 B1	1/2006	Coppinger et al.
6,920,430 B1	7/2005	Berton et al.	6,983,313 B1	1/2006	Korkea-Aho
6,920,464 B2	7/2005	Fox	6,985,747 B2	1/2006	Chithambaram
6,922,566 B2	7/2005	Puranik et al.	6,985,839 B1	1/2006	Motamedi et al.
6,925,378 B2	8/2005	Tzamaloukas	6,985,879 B2	1/2006	Walker et al.
6,925,381 B2	8/2005	Adamczyk	6,987,976 B2	1/2006	Kohar et al.
6,928,294 B2	8/2005	Maggenti et al.	6,989,765 B2	1/2006	Gueziec
6,930,634 B2	8/2005	Peng et al.	6,990,462 B1	1/2006	Wilcox et al.
6,933,841 B2	8/2005	Muramatsu et al.	6,990,472 B2	1/2006	Rosenhaft et al.
6,934,634 B1	8/2005	Ge	6,990,495 B1	1/2006	Grason et al.
6,937,187 B2	8/2005	van Diggelen et al.	6,993,327 B2	1/2006	Mathis
6,937,569 B1	8/2005	Sarkar et al.	6,993,355 B1	1/2006	Pershan
6,937,597 B1	8/2005	Rosenberg et al.	6,993,718 B2	1/2006	Fujihara
6,937,872 B2	8/2005	Krasner	6,996,087 B2	2/2006	Ejzak
6,938,076 B2	8/2005	Meyer et al.	6,996,251 B2	2/2006	Malone et al.
6,940,454 B2	9/2005	Paetzold et al.	6,996,387 B2	2/2006	Chan
6,940,826 B1	9/2005	Simard et al.	6,996,720 B1	2/2006	DeMello et al.
6,940,950 B2	9/2005	Dickinson et al.	6,999,779 B1	2/2006	Hashimoto
6,941,144 B2	9/2005	Stein	6,999,782 B2	2/2006	Shaughnessy et al.
6,943,671 B2	9/2005	McGee et al.	6,999,783 B2	2/2006	Toyryla et al.
6,944,443 B2	9/2005	Bates et al.	7,003,289 B1	2/2006	Kolls
6,944,447 B2	9/2005	Portman et al.	7,003,571 B1	2/2006	Zombek et al.
6,944,540 B2	9/2005	King et al.	7,003,604 B2	2/2006	Brelin
6,944,704 B2	9/2005	Brelin	7,006,829 B2	2/2006	Zhao et al.
6,944,760 B2	9/2005	Wills	7,007,010 B2	2/2006	Cooper
6,947,772 B2	9/2005	Minear et al.	7,007,228 B1	2/2006	Carro
6,947,880 B2	9/2005	Johnson et al.	7,009,556 B2	3/2006	Stewart
6,948,656 B2	9/2005	Williams	7,010,144 B1	3/2006	Davis et al.
6,950,058 B1	9/2005	Davis et al.	7,012,901 B2	3/2006	Jagadeesan et al.
6,950,326 B2	9/2005	Suzuki	7,013,148 B1	3/2006	Ganesh
6,950,535 B2	9/2005	Sibayama et al.	7,013,216 B2	3/2006	Walters et al.
6,952,181 B2	10/2005	Karr et al.	7,013,391 B2	3/2006	Herle et al.
6,952,574 B2	10/2005	Tealdi et al.	7,016,717 B2	3/2006	Demos et al.
6,954,442 B2	10/2005	Tsirsis et al.	7,016,855 B2	3/2006	Eaton et al.
6,954,641 B2	10/2005	McKenna et al.	7,020,460 B1	3/2006	Sherman et al.
6,954,735 B1	10/2005	Djupsjobacka et al.	7,020,494 B2	3/2006	Spiestersbach et al.
6,954,790 B2	10/2005	Forslow	7,020,701 B1	3/2006	Gelvin et al.
6,956,564 B1	10/2005	Williams	7,023,383 B2	4/2006	Stilp et al.
6,956,573 B1	10/2005	Bergen et al.	7,023,465 B2	4/2006	Stephens, Jr.
			7,023,980 B2	4/2006	Lenard
			7,024,200 B2	4/2006	McKenna et al.
			7,024,205 B1	4/2006	Hose
			7,024,207 B2	4/2006	Gorday et al.

(56)

## References Cited

## U.S. PATENT DOCUMENTS

7,024,214	B2	4/2006	Loveland	7,084,771	B2	8/2006	Gonzalez
7,024,278	B2	4/2006	Chiappetta et al.	7,085,365	B2	8/2006	Kauppinen
7,024,321	B1	4/2006	Deninger et al.	7,085,555	B2	8/2006	Zellner et al.
7,024,393	B1	4/2006	Peinado et al.	7,085,637	B2	8/2006	Breed et al.
7,026,926	B1	4/2006	Walker, III	7,085,678	B1	8/2006	Burrell et al.
7,026,928	B1	4/2006	Lane	7,085,818	B2	8/2006	Brown et al.
7,027,564	B2	4/2006	James	7,089,110	B2	8/2006	Pechatnikov et al.
7,027,819	B2	4/2006	Ozturk et al.	7,089,214	B2	8/2006	Wang
7,031,724	B2	4/2006	Ross et al.	7,089,264	B1	8/2006	Guido et al.
7,031,725	B2	4/2006	Rorabaugh	7,091,851	B2	8/2006	Mason et al.
7,031,728	B2	4/2006	Beyer, Jr.	7,091,852	B2	8/2006	Mason et al.
7,031,875	B2	4/2006	Ellenby et al.	7,092,385	B2	8/2006	Gallant et al.
7,032,030	B1	4/2006	Codignotto	7,092,573	B2	8/2006	Luo et al.
7,034,678	B2	4/2006	Burkley et al.	7,092,702	B2	8/2006	Cronin et al.
7,034,681	B2	4/2006	Yamamoto et al.	7,095,871	B2	8/2006	Jones et al.
7,035,618	B2	4/2006	Schnurr	7,096,029	B1	8/2006	Parupudi et al.
7,035,647	B2	4/2006	de Verteuil	7,096,030	B2	8/2006	Huomo
7,035,731	B2	4/2006	Smith	7,096,233	B2	8/2006	Mori et al.
7,038,590	B2	5/2006	Hoffman et al.	7,099,770	B2	8/2006	Naden et al.
7,039,596	B1	5/2006	Lu	7,103,018	B1	9/2006	Hansen et al.
7,039,599	B2	5/2006	Merriman et al.	7,103,368	B2	9/2006	Teshima
7,039,603	B2	5/2006	Walker et al.	7,103,370	B1	9/2006	Creemer
7,042,338	B1	5/2006	Weber	7,103,470	B2	9/2006	Mintz
7,042,361	B2	5/2006	Kazdin et al.	7,103,471	B2	9/2006	Levi et al.
7,042,391	B2	5/2006	Meunier et al.	7,103,574	B1	9/2006	Peinado et al.
7,043,256	B2	5/2006	Ozugur et al.	7,103,806	B1	9/2006	Horvitz
7,043,362	B2	5/2006	Krull et al.	7,106,717	B2	9/2006	Rousseau et al.
7,044,372	B2	5/2006	Okuda et al.	7,106,843	B1	9/2006	Gainsboro et al.
7,047,030	B2	5/2006	Forsyth	7,107,038	B2	9/2006	Fitch et al.
7,047,203	B2	5/2006	Johnson	7,107,065	B2	9/2006	Overy et al.
7,047,411	B1	5/2006	DeMello et al.	7,107,228	B1	9/2006	Walker et al.
7,047,549	B2	5/2006	Schein et al.	7,107,285	B2	9/2006	von Kaenel et al.
7,050,624	B2	5/2006	Dialameh et al.	7,110,749	B2	9/2006	Zellner et al.
7,050,655	B2	5/2006	Ho et al.	7,110,753	B2	9/2006	Campen
7,050,797	B2	5/2006	Jung	7,110,773	B1	9/2006	Wallace et al.
7,050,818	B2	5/2006	Tendler	7,110,880	B2	9/2006	Breed et al.
7,053,780	B1	5/2006	Straub et al.	7,113,110	B2	9/2006	Horstemeyer
7,053,822	B2	5/2006	Rickerson, Jr.	7,113,797	B2	9/2006	Kelley et al.
7,054,741	B2	5/2006	Harrison et al.	7,113,806	B2	9/2006	Gray
7,057,556	B2	6/2006	Hall et al.	7,116,977	B1	10/2006	Moton, Jr. et al.
7,057,591	B1	6/2006	Hautanen et al.	7,116,985	B2	10/2006	Wilson et al.
7,058,208	B2	6/2006	Chang et al.	7,117,015	B2	10/2006	Scheinert et al.
7,058,594	B2	6/2006	Stewart	7,117,088	B1	10/2006	Hanshaw et al.
7,062,269	B2	6/2006	Albertsson et al.	7,119,716	B2	10/2006	Horstemeyer
7,062,279	B2	6/2006	Cedervall et al.	7,120,444	B2	10/2006	Silvester
7,062,491	B2	6/2006	McNulty et al.	7,120,450	B2	10/2006	Hines et al.
7,062,510	B1	6/2006	Eldering	7,120,459	B2	10/2006	Sawada et al.
7,062,530	B2	6/2006	Scheinman	7,120,469	B1	10/2006	Urakawa
7,064,681	B2	6/2006	Horstemeyer	7,123,189	B2	10/2006	Lalik et al.
7,065,351	B2	6/2006	Carter et al.	7,123,693	B2	10/2006	Nelson et al.
7,065,507	B2	6/2006	Mohammed et al.	7,123,926	B2	10/2006	Himmelstein
7,065,548	B2	6/2006	van Oldenborgh et al.	7,124,174	B2	10/2006	Wyke et al.
7,069,016	B2	6/2006	Crisler et al.	7,124,370	B2	10/2006	Fish
7,069,023	B2	6/2006	Maanoja et al.	7,127,257	B2	10/2006	Riley et al.
7,069,026	B2	6/2006	McClure	7,127,261	B2	10/2006	Van Erlach
7,069,308	B2	6/2006	Abrams	7,128,274	B2	10/2006	Kelley et al.
7,069,319	B2	6/2006	Zellner et al.	7,130,385	B1	10/2006	Moon
7,071,821	B2	7/2006	Adamezyk et al.	7,130,406	B2	10/2006	Pines et al.
7,071,842	B1	7/2006	Brady, Jr.	7,130,646	B2	10/2006	Wang
7,072,454	B1	7/2006	Ward	7,133,365	B2	11/2006	Klinker et al.
7,072,645	B2	7/2006	Schwinke et al.	7,133,909	B2	11/2006	Bahl
7,072,665	B1	7/2006	Blumberg et al.	7,135,992	B2	11/2006	Karlsson et al.
7,072,667	B2	7/2006	Olrik et al.	7,136,466	B1	11/2006	Gao
7,072,672	B1	7/2006	Vanska et al.	7,136,663	B2	11/2006	Metais et al.
7,072,963	B2	7/2006	Anderson et al.	7,136,838	B1	11/2006	Peinado et al.
7,075,900	B2	7/2006	Peters	7,136,915	B2	11/2006	Rieger, III
7,076,235	B2	7/2006	Esque et al.	7,138,913	B2	11/2006	Mackenzie et al.
7,076,255	B2	7/2006	Parupudi et al.	7,139,252	B2	11/2006	Babu et al.
7,076,257	B2	7/2006	Kall	7,139,553	B2	11/2006	Alston
7,076,737	B2	7/2006	Abbott et al.	7,139,565	B2	11/2006	Fiatel et al.
7,079,857	B2	7/2006	Maggenti et al.	7,139,664	B2	11/2006	Kelly et al.
7,079,947	B2	7/2006	Runquist et al.	7,142,858	B2	11/2006	Aoki et al.
7,080,124	B1	7/2006	Shankar	7,142,900	B1	11/2006	Straub
7,082,365	B2	7/2006	Sheha et al.	7,143,130	B2	11/2006	Lin
7,084,758	B1	8/2006	Cole	7,145,900	B2	12/2006	Nix et al.
				7,146,129	B2	12/2006	Bostrom et al.
				7,149,503	B2	12/2006	Aarnio et al.
				7,149,533	B2	12/2006	Laird et al.
				7,149,625	B2	12/2006	Mathews et al.

(56)

## References Cited

## U.S. PATENT DOCUMENTS

7,150,030 B1	12/2006	Eldering et al.	7,225,207 B1	5/2007	Ohazama et al.
7,151,921 B2	12/2006	Otsuka	7,228,136 B2	6/2007	Myllymaki et al.
7,151,946 B2	12/2006	Maggenti et al.	7,231,218 B2	6/2007	Diacakis et al.
7,155,238 B2	12/2006	Katz	7,231,219 B2	6/2007	Curtis et al.
7,155,339 B2	12/2006	Tu	7,231,423 B1	6/2007	Horstmann et al.
7,155,521 B2	12/2006	Lahti et al.	7,233,786 B1	6/2007	Harris et al.
7,158,883 B2	1/2007	Fuchs et al.	7,234,117 B2	6/2007	Zaner et al.
7,158,980 B2	1/2007	Shen	7,234,942 B2	6/2007	Hu et al.
7,162,221 B2	1/2007	Spitz et al.	7,236,742 B2	6/2007	Hall et al.
7,162,256 B2	1/2007	Seligmann et al.	7,236,799 B2	6/2007	Wilson et al.
7,162,454 B1	1/2007	Donner et al.	7,236,973 B2	6/2007	Kalthoff et al.
7,164,117 B2	1/2007	Breed et al.	7,237,019 B2	6/2007	Sogabe et al.
7,164,883 B2	1/2007	Rappaport et al.	7,237,201 B2	6/2007	Fish
7,164,921 B2	1/2007	Owens et al.	7,239,759 B2	7/2007	Nam et al.
7,164,986 B2	1/2007	Humphries et al.	7,239,943 B2	7/2007	Peltz
7,165,725 B2	1/2007	Casey	7,240,036 B1	7/2007	Mamdani et al.
7,167,711 B1	1/2007	Dennis	7,242,303 B2	7/2007	Patel et al.
7,167,713 B2	1/2007	Anderson	7,242,950 B2	7/2007	Suryanarayana et al.
7,170,863 B1	1/2007	Denman et al.	7,243,355 B2	7/2007	Espino
7,171,190 B2	1/2007	Ye et al.	7,246,371 B2	7/2007	Diacakis et al.
7,171,198 B2	1/2007	Paila et al.	7,248,677 B2	7/2007	Randall et al.
7,174,153 B2	2/2007	Ehlers	7,248,884 B2	7/2007	Miyamoto
7,174,277 B2	2/2007	Vock et al.	7,248,965 B2	7/2007	Tanizaki et al.
7,177,397 B2	2/2007	McCalmont et al.	7,250,907 B2	7/2007	Krumm et al.
7,177,398 B2	2/2007	Meer et al.	7,251,312 B2	7/2007	D'Evelyn et al.
7,177,399 B2	2/2007	Dawson et al.	7,251,561 B2	7/2007	Dotan et al.
7,177,904 B1	2/2007	Mathur et al.	7,251,696 B1	7/2007	Horvitz
7,181,189 B2	2/2007	Hotta et al.	7,254,388 B2	8/2007	Nam et al.
7,181,200 B2	2/2007	Malackowski et al.	7,254,406 B2	8/2007	Beros et al.
7,181,227 B2	2/2007	Wilson et al.	7,254,481 B2	8/2007	Yamada et al.
7,184,750 B2	2/2007	Tervo et al.	7,256,711 B2	8/2007	Sheha et al.
7,184,790 B2	2/2007	Dorenbosch et al.	7,256,737 B2	8/2007	Hall et al.
7,185,352 B2	2/2007	Hallford et al.	7,257,392 B2	8/2007	Tang et al.
7,187,997 B2	3/2007	Johnson	7,257,416 B2	8/2007	Lee et al.
7,190,948 B2	3/2007	Donley et al.	7,260,186 B2	8/2007	Zhu et al.
7,190,960 B2	3/2007	Wilson et al.	7,260,378 B2	8/2007	Holland et al.
7,194,273 B2	3/2007	Vaudreuil	7,260,384 B2	8/2007	Bales et al.
7,196,639 B2	3/2007	Joyce et al.	7,263,437 B2	8/2007	Hirose et al.
7,197,321 B2	3/2007	Erskine et al.	7,266,376 B2	9/2007	Nakagawa
7,199,754 B2	4/2007	Krumm et al.	7,266,378 B2	9/2007	Norta et al.
7,199,815 B2	4/2007	Aoyama	7,266,379 B2	9/2007	Blight et al.
7,200,380 B2	4/2007	Havlark et al.	7,266,836 B2	9/2007	Anttila et al.
7,200,394 B2	4/2007	Aoki et al.	7,269,425 B2	9/2007	Valko et al.
7,200,409 B1	4/2007	Ichikawa et al.	7,269,590 B2	9/2007	Hull et al.
7,200,566 B1	4/2007	Moore et al.	7,269,601 B2	9/2007	Kinno et al.
7,202,776 B2	4/2007	Breed	7,269,636 B2	9/2007	McCollum et al.
7,202,814 B2	4/2007	Caspi et al.	7,269,821 B2	9/2007	Sahinoja et al.
7,203,502 B2	4/2007	Wilson et al.	7,271,742 B2	9/2007	Sheha et al.
7,203,674 B2	4/2007	Cohen	7,271,765 B2	9/2007	Stilp et al.
7,203,752 B2	4/2007	Rice et al.	7,273,172 B2	9/2007	Olsen, III et al.
7,206,388 B2	4/2007	Diacakis	7,274,299 B2	9/2007	Osman
7,206,568 B2	4/2007	Sudit	7,274,332 B1	9/2007	Dupray
7,206,828 B1	4/2007	Bourke-Dunphy et al.	7,274,924 B2	9/2007	Yoshioka
7,209,571 B2	4/2007	Davis et al.	7,274,939 B2	9/2007	Ruutu et al.
7,209,753 B2	4/2007	Raith	7,277,912 B2	10/2007	Corboy et al.
7,209,755 B2	4/2007	Gorday et al.	7,277,923 B2	10/2007	Rensin et al.
7,209,758 B1	4/2007	Moll et al.	7,280,822 B2	10/2007	Fraccaroli
7,209,969 B2	4/2007	Lahti et al.	7,280,975 B1	10/2007	Donner
7,212,111 B2	5/2007	Tupler et	7,283,846 B2	10/2007	Spriestersbach et al.
7,212,806 B2	5/2007	Karaoguz	7,284,033 B2	10/2007	Jhanji
7,213,048 B1	5/2007	Parupudi et al.	7,284,064 B1	10/2007	Connelly
7,215,967 B1	5/2007	Kransmo et al.	7,289,617 B2	10/2007	Barnes et al.
7,216,109 B1	5/2007	Donner	7,289,813 B2	10/2007	Karaoguz
7,218,242 B2	5/2007	Scalisi et al.	7,289,814 B2	10/2007	Amir et al.
7,218,940 B2	5/2007	Niemenmaa et al.	7,289,904 B2	10/2007	Uyeki
7,219,303 B2	5/2007	Fish	7,292,142 B2	11/2007	Simon et al.
7,221,937 B2	5/2007	Lau et al.	7,292,685 B2	11/2007	Gray
7,221,948 B2	5/2007	Tokkonen	7,292,935 B2	11/2007	Yoon
7,221,959 B2	5/2007	Lindqvist et al.	7,295,556 B2	11/2007	Roese et al.
7,222,018 B2	5/2007	Uyeki et al.	7,298,327 B2	11/2007	Dupray et al.
7,224,963 B2	5/2007	Anderson et al.	7,299,008 B2	11/2007	Gluck
7,224,966 B2	5/2007	Caspi et al.	7,301,469 B1	11/2007	Hoffman et al.
7,224,978 B2	5/2007	Zellner et al.	7,301,536 B2	11/2007	Ellenby et al.
7,224,987 B1	5/2007	Bhela et al.	7,302,254 B2	11/2007	Valloppillil
7,224,995 B2	5/2007	Rhoads	7,302,634 B2	11/2007	Lucovsky et al.
			7,304,966 B2	12/2007	Phan-Anh et al.
			7,305,365 B1	12/2007	Bhela et al.
			7,305,442 B1	12/2007	Lundy
			7,305,700 B2	12/2007	Boynton et al.

(56)

## References Cited

## U.S. PATENT DOCUMENTS

7,307,636	B2	12/2007	Matraszek et al.	7,394,896	B2	7/2008	Norton
7,308,356	B2	12/2007	Melaku et al.	7,395,031	B1	7/2008	Ritter
7,310,676	B2	12/2007	Bourne	7,395,045	B2	7/2008	Jijina et al.
7,315,746	B2	1/2008	Caspi et al.	7,395,259	B2	7/2008	Bailey et al.
7,317,705	B2	1/2008	Hanson	7,397,379	B2	7/2008	Richards et al.
7,317,927	B2	1/2008	Staton et al.	7,398,151	B1	7/2008	Burrell et al.
7,318,041	B2	1/2008	Walker et al.	7,401,057	B2	7/2008	Eder
7,319,414	B2	1/2008	Horstemeyer	7,403,221	B2	7/2008	Yamazaki et al.
7,319,931	B2	1/2008	Uyeki et al.	7,403,786	B2	7/2008	Caspi et al.
7,321,773	B2	1/2008	Hines et al.	7,403,908	B1	7/2008	Jaramillo
7,324,987	B2	1/2008	Hsieh et al.	7,403,942	B1	7/2008	Bayliss
7,327,245	B2	2/2008	Krumm et al.	7,403,972	B1	7/2008	Lau et al.
7,327,312	B1	2/2008	Harris	7,406,507	B2	7/2008	Piccioni
7,328,242	B1	2/2008	McCarthy et al.	7,406,665	B2	7/2008	Yokota
7,328,455	B2	2/2008	Jutzi et al.	7,409,384	B2	8/2008	Szeto et al.
7,330,112	B1	2/2008	Emigh et al.	7,412,260	B2	8/2008	Gailey et al.
7,330,895	B1	2/2008	Horvitz	7,412,313	B2	8/2008	Isaac
7,330,899	B2	2/2008	Wong	7,413,513	B2	8/2008	Nguyen et al.
7,333,480	B1	2/2008	Clarke et al.	7,414,637	B2	8/2008	Fogel et al.
7,333,819	B2	2/2008	Caspi et al.	7,418,265	B2	8/2008	Hardy et al.
7,333,820	B2	2/2008	Sheha et al.	7,418,402	B2	8/2008	McCrossin et al.
7,333,956	B2	2/2008	Malcolm	7,421,154	B2	9/2008	Kinjo
7,334,728	B2	2/2008	Williams	7,421,422	B1	9/2008	Dempster et al.
7,336,819	B2	2/2008	Gallagher et al.	7,421,486	B1	9/2008	Parupudi et al.
7,336,928	B2	2/2008	Paalasmaa et al.	7,421,577	B2	9/2008	Ichikawa et al.
7,336,949	B2	2/2008	Nasielski	7,423,538	B2	9/2008	Gonzalez
7,337,061	B2	2/2008	Naden et al.	7,424,293	B2	9/2008	Zhu
7,337,210	B2	2/2008	Barsness	7,424,363	B2	9/2008	Cheng et al.
7,337,465	B2	2/2008	Kiyoto et al.	7,426,380	B2	9/2008	Hines et al.
7,339,496	B2	3/2008	Endo et al.	7,426,403	B2	9/2008	Sundararajan et al.
7,340,057	B2	3/2008	Martin, Jr. et al.	7,428,417	B2	9/2008	Caspi et al.
7,340,240	B2	3/2008	McDonald	7,428,571	B2	9/2008	Ichimura
7,340,389	B2	3/2008	Vargas	7,433,672	B2	10/2008	Wood
7,340,691	B2	3/2008	Bassett et al.	7,433,694	B2	10/2008	Morgan et al.
7,343,141	B2	3/2008	Ellis et al.	7,436,785	B1	10/2008	McMullen et al.
7,343,165	B2	3/2008	Obradovich	7,437,413	B2	10/2008	Okuyama et al.
7,343,222	B2	3/2008	Solomon	7,437,444	B2	10/2008	Houri
7,343,317	B2	3/2008	Jokinen et al.	7,439,847	B2	10/2008	Pederson
7,343,408	B2	3/2008	Kushwaha et al.	7,440,442	B2	10/2008	Grabelsky et al.
7,349,706	B2	3/2008	Kim et al.	7,440,573	B2	10/2008	Lor et al.
7,350,236	B1	3/2008	Silverbroom et al.	7,440,842	B1	10/2008	Vorona
7,350,237	B2	3/2008	Vogel et al.	7,441,203	B2	10/2008	Othmer et al.
7,353,016	B2	4/2008	Roundtree et al.	7,441,706	B1	10/2008	Schuessler et al.
7,353,034	B2	4/2008	Haney	7,447,508	B1	11/2008	Tendler
7,353,139	B1	4/2008	Burrell et al.	7,450,934	B2	11/2008	Caspi et al.
7,355,528	B2	4/2008	Yamane et al.	7,453,219	B2	11/2008	Mor et al.
7,359,706	B2	4/2008	Zhao	7,455,586	B2	11/2008	Nguyen et al.
7,359,713	B1	4/2008	Tiwari	7,457,628	B2	11/2008	Blumberg et al.
7,359,724	B2	4/2008	Torvinen	7,457,634	B2	11/2008	Morinaga et al.
7,359,894	B1	4/2008	Liebman et al.	7,458,080	B2	11/2008	Parker et al.
7,362,662	B2	4/2008	Lang	7,460,863	B2	12/2008	Steelberg et al.
7,363,024	B2	4/2008	Jenkins	7,461,528	B2	12/2008	Taniguchi et al.
7,363,027	B2	4/2008	Hon et al.	7,463,151	B1	12/2008	Schulte-Kellinghaus
7,366,522	B2	4/2008	Thomas	7,463,972	B2	12/2008	Yamada et al.
7,366,606	B2	4/2008	Uyeki	7,464,050	B1	12/2008	Deaton et al.
7,366,779	B1	4/2008	Crawford	7,469,298	B2	12/2008	Kitada et al.
7,369,508	B2	5/2008	Parantainen et al.	7,472,172	B2	12/2008	Anderson et al.
7,369,530	B2	5/2008	Keagy	7,472,202	B2	12/2008	Parupudi et al.
7,370,283	B2	5/2008	Othmer	7,472,338	B2	12/2008	Carro
7,373,820	B1	5/2008	James	7,472,396	B2	12/2008	Jacobs et al.
7,376,433	B1	5/2008	Hose	7,474,741	B2	1/2009	Brunson et al.
7,376,591	B2	5/2008	Owens	7,474,896	B2	1/2009	Mohi et al.
7,376,640	B1	5/2008	Anderson et al.	7,474,959	B2	1/2009	Singh
7,379,889	B2	5/2008	Ratzlaff et al.	7,475,057	B1	1/2009	Obradovich
7,382,770	B2	6/2008	Bergman et al.	7,475,059	B2	1/2009	Irle et al.
7,382,773	B2	6/2008	Schoeneberger et al.	7,477,694	B2	1/2009	Sanderford, Jr. et al.
7,383,316	B2	6/2008	Koch et al.	7,477,873	B2	1/2009	Tanaka et al.
7,385,499	B2	6/2008	Horton et al.	7,477,906	B2	1/2009	Radice et al.
7,386,000	B2	6/2008	Lopponen et al.	7,478,055	B2	1/2009	Goino
7,386,392	B1	6/2008	Kabel et al.	7,478,078	B2	1/2009	Lunt et al.
7,386,477	B2	6/2008	Fano	7,479,899	B2	1/2009	Horstemeyer
7,388,519	B1	6/2008	Kreft	7,479,983	B2	1/2009	Fisher et al.
7,389,179	B2	6/2008	Jin et al.	7,480,566	B2	1/2009	Laverty
7,389,275	B2	6/2008	Kemper et al.	7,480,567	B2	1/2009	Suomela et al.
7,389,351	B2	6/2008	Horvitz	7,483,944	B2	1/2009	Parupudi et al.
				7,483,946	B2	1/2009	Boyd
				7,484,176	B2	1/2009	Blattner et al.
				7,486,958	B2	2/2009	Sheha et al.
				7,487,148	B2	2/2009	James

(56)

## References Cited

## U.S. PATENT DOCUMENTS

7,489,938 B2	2/2009	Flynn et al.	7,617,128 B2	11/2009	Greak
7,490,056 B2	2/2009	Nash	7,617,176 B2	11/2009	Zeng et al.
7,490,144 B2	2/2009	Carlson et al.	7,620,404 B2	11/2009	Chesnais et al.
7,493,363 B2	2/2009	Huitema et al.	7,620,621 B2	11/2009	Fuselier et al.
7,496,082 B2	2/2009	Lee	7,623,848 B2	11/2009	Rosenfelt et al.
7,496,347 B2	2/2009	Puranik	7,623,860 B2	11/2009	Hurst
7,496,633 B2	2/2009	Szeto et al.	7,623,871 B2	11/2009	Sheynblat
7,496,648 B2	2/2009	Manion et al.	7,623,966 B2	11/2009	Butler, Jr.
7,499,714 B2	3/2009	Ki	7,627,425 B2	12/2009	Salmre et al.
7,502,133 B2	3/2009	Fukunaga et al.	7,627,498 B1	12/2009	Walker et al.
7,502,610 B2	3/2009	Maher	7,630,986 B1	12/2009	Herz et al.
7,503,074 B2	3/2009	Dublish et al.	7,636,755 B2	12/2009	Blattner et al.
7,509,422 B2	3/2009	Jaffray et al.	7,640,009 B2	12/2009	Belkin et al.
7,512,407 B2	3/2009	Wu et al.	7,640,300 B2	12/2009	Wohlgemuth et al.
7,512,544 B2	3/2009	Carter et al.	7,643,834 B2	1/2010	Ioppe et al.
7,519,372 B2	4/2009	MacDonald et al.	7,644,144 B1	1/2010	Horvitz et al.
7,519,548 B2	4/2009	Hanechak et al.	7,644,166 B2	1/2010	Appelman et al.
7,519,703 B1	4/2009	Stuart et al.	7,649,872 B2	1/2010	Naghian et al.
7,522,627 B2	4/2009	Lam et al.	7,650,142 B2	1/2010	Longman et al.
7,522,911 B2	4/2009	Ung et al.	7,653,574 B2	1/2010	Harper et al.
7,522,995 B2	4/2009	Nortrup	7,657,079 B2	2/2010	Lake et al.
7,523,191 B1	4/2009	Thomas et al.	7,663,502 B2	2/2010	Breed
7,525,484 B2	4/2009	Dupray et al.	7,664,233 B1	2/2010	Kirchmeier et al.
7,525,955 B2	4/2009	Velez-Rivera et al.	7,664,509 B2	2/2010	Zellner et al.
7,526,306 B2	4/2009	Brems et al.	7,668,649 B2	2/2010	Onishi
7,529,556 B2	5/2009	Dunko et al.	7,668,832 B2	2/2010	Yeh et al.
7,529,557 B2	5/2009	Farrill	7,668,864 B2	2/2010	Benson et al.
7,529,617 B2	5/2009	Ono et al.	7,670,263 B2	3/2010	Ellis et al.
7,529,723 B2	5/2009	Howard et al.	7,672,439 B2	3/2010	Appelman et al.
7,532,809 B2	5/2009	Boston et al.	7,672,440 B2	3/2010	Chen et al.
7,532,878 B2	5/2009	Hagebarth	7,672,639 B2	3/2010	Vaddiparty et al.
7,532,899 B2	5/2009	Wilson et al.	7,675,889 B2	3/2010	Nakao et al.
7,536,256 B2	5/2009	Kelley et al.	7,680,340 B2	3/2010	Luo et al.
7,536,437 B2	5/2009	Zmolek	7,680,796 B2	3/2010	Yeh et al.
7,538,745 B2	5/2009	Borovoy et al.	7,680,942 B2	3/2010	Tu et al.
7,545,784 B2	6/2009	Mgrdechian et al.	7,685,279 B2	3/2010	Miltonberger et al.
7,545,916 B2	6/2009	Schwartz	7,688,211 B2	3/2010	Borovoy et al.
7,546,127 B2	6/2009	Caspi et al.	7,688,260 B2	3/2010	Pomerantz et al.
7,551,733 B2	6/2009	Denny et al.	7,688,811 B2	3/2010	Kubler et al.
7,558,584 B2	7/2009	Yamamoto et al.	7,693,752 B2	4/2010	Jaramillo
7,558,696 B2	7/2009	Vilppula et al.	7,693,944 B2	4/2010	Appelman et al.
7,564,348 B2	7/2009	Staton et al.	7,696,905 B2	4/2010	Ellenby et al.
7,565,153 B2	7/2009	Alcock et al.	7,698,228 B2	4/2010	Gailey et al.
7,565,155 B2	7/2009	Sheha et al.	7,702,728 B2	4/2010	Zaner et al.
7,568,025 B2	7/2009	Vasudeva	7,702,739 B1	4/2010	Cheng et al.
7,568,203 B2	7/2009	Dotan et al.	7,706,516 B2	4/2010	Seligmann
7,570,668 B2	8/2009	Mettala et al.	7,706,970 B2	4/2010	Inoue
7,573,825 B2	8/2009	Iffland	7,706,977 B2	4/2010	Soehren
7,573,843 B2	8/2009	Koss	7,707,109 B2	4/2010	Odijk et al.
7,573,982 B2	8/2009	Breen et al.	7,707,122 B2	4/2010	Hull et al.
7,574,222 B2	8/2009	Sawada et al.	7,707,262 B1	4/2010	Bill
7,577,131 B2	8/2009	Joseph et al.	7,711,604 B1	5/2010	Walker et al.
7,577,448 B2	8/2009	Pande et al.	7,714,712 B2	5/2010	Emigh et al.
7,577,747 B2	8/2009	Banet et al.	7,714,778 B2	5/2010	Dupray
7,580,384 B2	8/2009	Kubler et al.	7,716,287 B2	5/2010	Appelman et al.
7,584,114 B2	9/2009	Estrada et al.	7,716,585 B2	5/2010	Glass
7,586,861 B2	9/2009	Kubler et al.	7,717,866 B2	5/2010	Damen
7,587,345 B2	9/2009	Mann et al.	7,721,084 B2	5/2010	Salminen et al.
7,590,589 B2	9/2009	Hoffberg	7,724,743 B2	5/2010	Razdan et al.
7,593,605 B2	9/2009	King et al.	7,725,550 B2	5/2010	Choi
7,593,718 B2	9/2009	Gorday et al.	7,728,724 B1	6/2010	Scalisi et al.
7,596,625 B2	9/2009	Manion et al.	7,729,691 B2	6/2010	Newville
7,599,580 B2	10/2009	King et al.	7,730,012 B2	6/2010	Arrouye et al.
7,599,790 B2	10/2009	Rasmussen et al.	7,730,014 B2	6/2010	Hartenstein et al.
7,599,983 B2	10/2009	Harper et al.	7,730,063 B2	6/2010	Eder
7,603,112 B2	10/2009	Huomo et al.	7,730,129 B2	6/2010	Wang et al.
7,603,229 B2	10/2009	Goldberg et al.	7,730,389 B2	6/2010	Rasmussen et al.
7,606,416 B2	10/2009	Han et al.	7,738,896 B2	6/2010	Patel et al.
7,606,577 B2	10/2009	Caspi et al.	7,743,074 B1	6/2010	Parupudi et al.
7,606,663 B2	10/2009	Neef et al.	7,747,258 B2	6/2010	Farmer
7,606,687 B2	10/2009	Galbreath et al.	7,747,719 B1	6/2010	Horvitz et al.
7,606,741 B2	10/2009	King et al.	7,756,253 B2	7/2010	Breen et al.
7,610,145 B2	10/2009	Kantarjiev et al.	7,756,537 B2	7/2010	Laurila et al.
7,613,634 B2	11/2009	Siegel et al.	7,756,639 B2	7/2010	Colley et al.
7,613,812 B2	11/2009	Manion et al.	7,761,309 B2	7/2010	Sacco et al.
			7,764,231 B1	7/2010	Karr et al.
			7,764,944 B2	7/2010	Rollender
			7,764,950 B2	7/2010	Patel et al.
			7,764,961 B2	7/2010	Zhu et al.

(56)

## References Cited

## U.S. PATENT DOCUMENTS

7,765,206 B2	7/2010	Hillis et al.	RE42,738 E	9/2011	Williams
7,769,975 B2	8/2010	Ripberger	8,019,355 B2	9/2011	Shim
7,774,158 B2	8/2010	Domingues Goncalves et al.	8,019,630 B2	9/2011	Dale
7,774,418 B2	8/2010	Tang et al.	8,023,958 B2	9/2011	Wang et al.
7,774,453 B2	8/2010	Babu et al.	8,027,333 B2	9/2011	Grabelsky et al.
7,783,297 B2	8/2010	Ishii	8,032,149 B2	10/2011	Kennedy et al.
7,784,684 B2	8/2010	Labrou et al.	8,043,159 B2	10/2011	Bae et al.
7,787,896 B2	8/2010	Kundu et al.	8,046,000 B2	10/2011	Sylvain
7,788,260 B2	8/2010	Lunt et al.	RE42,927 E	11/2011	Want et al.
7,792,273 B2	9/2010	Fano et al.	8,065,235 B2	11/2011	Narayanaswami et al.
7,793,316 B2	9/2010	Mears et al.	8,073,895 B2	12/2011	Hamzeh et al.
7,797,204 B2	9/2010	Balent	8,078,189 B2	12/2011	Chang et al.
7,797,367 B1	9/2010	Gelvin et al.	8,126,889 B2	2/2012	Pitt
7,802,724 B1	9/2010	Nohr	8,140,658 B1	3/2012	Gelvin et al.
RE41,899 E	10/2010	Rose et al.	8,150,617 B2	4/2012	Manber et al.
7,812,766 B2	10/2010	Leblanc et al.	8,280,624 B2	10/2012	Riise et al.
7,813,722 B2	10/2010	Patel et al.	8,312,083 B2	11/2012	Ahn et al.
7,813,741 B2	10/2010	Hendrey et al.	8,417,763 B2	4/2013	Stewart
7,813,873 B2	10/2010	Smartt et al.	8,706,542 B2	4/2014	O'Meara et al.
7,814,502 B2	10/2010	Blomqvist et al.	2001/0011247 A1	8/2001	O'Flaherty et al.
7,818,317 B1	10/2010	Emigh et al.	2001/0029465 A1	10/2001	Strisower
7,822,425 B2	10/2010	Shim et al.	2001/0033286 A1	10/2001	Stokes et al.
7,822,426 B1	10/2010	Wuersch	2001/0040886 A1	11/2001	Jimenez et al.
7,827,176 B2	11/2010	Korte et al.	2001/0041021 A1	11/2001	Boyle et al.
7,827,279 B2	11/2010	Xu et al.	2001/0044310 A1	11/2001	Lincke
7,828,655 B2	11/2010	Uhlir et al.	2001/0048364 A1	12/2001	Kalthoff et al.
7,831,668 B2	11/2010	Deeds	2001/0049274 A1	12/2001	Degraeve
7,840,224 B2	11/2010	Vengroff et al.	2001/0049671 A1	12/2001	Joerg
7,840,681 B2	11/2010	Acharya et al.	2001/0055975 A1*	12/2001	McDonnell et al. .... 455/456
7,840,699 B2	11/2010	Fujita et al.	2001/0055976 A1	12/2001	Crouch et al.
7,844,132 B2	11/2010	Boese et al.	2002/0000930 A1	1/2002	Crowson et al.
7,844,254 B2	11/2010	Arnold et al.	2002/0002504 A1	1/2002	Engel et al.
7,844,687 B1	11/2010	Gelvin et al.	2002/0002899 A1	1/2002	Gjerdingen et al.
7,848,760 B2	12/2010	Caspi et al.	2002/0016197 A1	2/2002	Candelaria
7,848,761 B2	12/2010	Caspi et al.	2002/0019829 A1	2/2002	Shapiro
7,848,948 B2	12/2010	Perkowski et al.	2002/0022993 A1	2/2002	Miller et al.
7,853,268 B2	12/2010	Karaoguz et al.	2002/0026289 A1	2/2002	Kusunuki et al.
7,853,272 B2	12/2010	Tipnis et al.	2002/0030665 A1	3/2002	Ano
7,856,311 B2	12/2010	Matsuura et al.	2002/0035493 A1	3/2002	Mozayeny et al.
7,860,519 B2	12/2010	Portman et al.	2002/0035609 A1	3/2002	Lessard et al.
7,869,816 B2	1/2011	Merheb et al.	2002/0036122 A1	3/2002	Fayette et al.
7,870,240 B1	1/2011	Horvitz	2002/0037735 A1	3/2002	Maggenti et al.
7,873,639 B2	1/2011	Shipman	2002/0042266 A1	4/2002	Heyward et al.
7,877,275 B2	1/2011	Ball	2002/0046069 A1	4/2002	Mozayeny et al.
7,885,898 B2	2/2011	Narayanaswami et al.	2002/0046077 A1	4/2002	Mozayeny et al.
7,893,826 B2	2/2011	Stenlund	2002/0046084 A1	4/2002	Steele et al.
7,895,263 B1	2/2011	Kirchmeier et al.	2002/0046232 A1	4/2002	Adams et al.
7,899,473 B2	3/2011	Pohutsky et al.	2002/0052214 A1	5/2002	Maggenti et al.
7,899,682 B2	3/2011	Sacco et al.	2002/0052786 A1	5/2002	Kim et al.
7,900,039 B2	3/2011	Shim et al.	2002/0054174 A1	5/2002	Abbott et al.
7,904,244 B2	3/2011	Sugla	2002/0055373 A1	5/2002	King et al.
7,904,511 B2	3/2011	Ryan et al.	2002/0055924 A1	5/2002	Liming
7,917,153 B2	3/2011	Orwant et al.	2002/0055926 A1	5/2002	Dan et al.
7,917,157 B2	3/2011	Muhonen	2002/0061760 A1	5/2002	Maggenti et al.
7,917,414 B2	3/2011	Nathanson	2002/0077119 A1	6/2002	Fitch et al.
7,920,871 B2	4/2011	Okuda	2002/0077144 A1	6/2002	Keller et al.
7,930,342 B2	4/2011	Mattila et al.	2002/0077897 A1	6/2002	Zellner et al.
7,937,066 B2	5/2011	Kaltsukis	2002/0091991 A1	7/2002	Castro
7,940,746 B2	5/2011	Livingood	2002/0094787 A1	7/2002	Avnet et al.
7,941,161 B2	5/2011	Ioppe et al.	2002/0098832 A1	7/2002	Fleischer et al.
7,941,162 B2	5/2011	Ioppe et al.	2002/0099769 A1	7/2002	Yasui et al.
7,944,909 B2	5/2011	James	2002/0111154 A1	8/2002	Eldering et al.
7,945,276 B2	5/2011	Pedersen	2002/0111172 A1	8/2002	DeWolf et al.
7,945,494 B2	5/2011	Williams	2002/0112047 A1	8/2002	Kushwaha et al.
7,958,457 B1	6/2011	Brandenberg et al.	2002/0112237 A1	8/2002	Kelts
7,967,678 B2	6/2011	Dougherty et al.	2002/0115453 A1	8/2002	Poulin et al.
7,969,306 B2	6/2011	Ebert et al.	2002/0116336 A1	8/2002	Diacakis et al.
7,970,749 B2	6/2011	Uhlir et al.	2002/0123327 A1	9/2002	Vataja
7,974,388 B2	7/2011	Sadot	2002/0126146 A1	9/2002	Burns et al.
7,974,868 B2	7/2011	Tseng et al.	2002/0126656 A1	9/2002	Park
7,983,226 B2	7/2011	Oommen et al.	2002/0127530 A1	9/2002	Weakly
7,996,025 B2	8/2011	Lee	2002/0128773 A1	9/2002	Chowanic et al.
7,996,465 B2	8/2011	Cromp et al.	2002/0140560 A1	10/2002	Altman et al.
8,000,724 B1	8/2011	Rayburn et al.	2002/0154213 A1	10/2002	Sibyama et al.
8,010,100 B2	8/2011	Kushwaha et al.	2002/0160815 A1	10/2002	Patel et al.
			2002/0161633 A1	10/2002	Jacob et al.
			2002/0164993 A1	11/2002	Elliot
			2002/0165771 A1	11/2002	Walker et al.
			2002/0165773 A1	11/2002	Natsuno et al.

(56)

References Cited

U.S. PATENT DOCUMENTS

2002/0167442 A1	11/2002	Taylor	2004/0044674 A1	3/2004	Mohammadioun et al.
2002/0169539 A1*	11/2002	Menard et al. .... 701/200	2004/0068439 A1	4/2004	Elgrably
2002/0173905 A1	11/2002	Jin et al.	2004/0068724 A1	4/2004	Gardner, III et al.
2002/0177449 A1	11/2002	McDonnell et al.	2004/0072583 A1	4/2004	Weng
2002/0178088 A1	11/2002	Lurie et al.	2004/0073361 A1	4/2004	Tzamaloukas et al.
2002/0183059 A1	12/2002	Noreen et al.	2004/0083050 A1	4/2004	Biyani
2002/0183072 A1	12/2002	Steinbach et al.	2004/0102201 A1	5/2004	Levin
2002/0186164 A1	12/2002	Hsu et al.	2004/0103182 A1	5/2004	Krabel et al.
2002/0191595 A1	12/2002	Mar et al.	2004/0106415 A1*	6/2004	Maeda et al. .... 455/456.1
2003/0003933 A1	1/2003	Deshpande et al.	2004/0110515 A1*	6/2004	Blumberg et al. .... 455/456.1
2003/0013449 A1	1/2003	Hose et al.	2004/0139049 A1	7/2004	Hancock et al.
2003/0023586 A1	1/2003	Knorr	2004/0158584 A1	8/2004	Necsoiu et al.
2003/0032404 A1	2/2003	Wager et al.	2004/0176907 A1	9/2004	Nesbitt
2003/0033582 A1	2/2003	Klein et al.	2004/0181807 A1	9/2004	Theiste et al.
2003/0035567 A1	2/2003	Chang et al.	2004/0186854 A1	9/2004	Choi
2003/0037110 A1	2/2003	Yamamoto	2004/0192349 A1	9/2004	Reilly
2003/0040272 A1	2/2003	Lelievre et al.	2004/0192351 A1	9/2004	Duncan
2003/0040944 A1	2/2003	Hileman	2004/0198332 A1	10/2004	Lundsgaard
2003/0055560 A1	3/2003	Phillips	2004/0198374 A1	10/2004	Bajikar
2003/0055983 A1	3/2003	Callegari	2004/0198379 A1	10/2004	Magee et al.
2003/0056218 A1	3/2003	Wingard et al.	2004/0198386 A1	10/2004	Dupray
2003/0060213 A1	3/2003	Heinonen et al.	2004/0198397 A1	10/2004	Weiss
2003/0060215 A1	3/2003	Graham	2004/0203630 A1	10/2004	Wang
2003/0060976 A1	3/2003	Sato et al.	2004/0203746 A1	10/2004	Knauerhase et al.
2003/0061206 A1	3/2003	Qian	2004/0203845 A1	10/2004	Lal
2003/0061211 A1	3/2003	Shultz et al.	2004/0203847 A1	10/2004	Knauerhase et al.
2003/0064705 A1	4/2003	Desiderio	2004/0203854 A1	10/2004	Nowak
2003/0065788 A1	4/2003	Salomaki	2004/0203890 A1	10/2004	Karaoguz et al.
2003/0065934 A1	4/2003	Angelo et al.	2004/0203909 A1	10/2004	Koster
2003/0069683 A1	4/2003	Lapidot et al.	2004/0203923 A1	10/2004	Mullen
2003/0074136 A1	4/2003	Hancock et al.	2004/0204842 A1	10/2004	Shinozaki
2003/0078064 A1	4/2003	Chan	2004/0205151 A1	10/2004	Sprigg et al.
2003/0078886 A1	4/2003	Minear et al.	2004/0215516 A1	10/2004	Denoon et al.
2003/0087647 A1	5/2003	Hurst	2004/0219933 A1	11/2004	Faith
2003/0087648 A1	5/2003	Mezhvinsky et al.	2004/0235493 A1	11/2004	Ekerborn
2003/0096621 A1	5/2003	Jana et al.	2004/0236504 A1	11/2004	Bickford et al.
2003/0096628 A1	5/2003	Bar-On et al.	2004/0242149 A1	12/2004	Luneau
2003/0097468 A1	5/2003	Hamadi	2004/0243307 A1	12/2004	Geelen
2003/0100316 A1	5/2003	Odamura	2004/0243941 A1*	12/2004	Fish ..... 715/752
2003/0100320 A1	5/2003	Ranjan	2004/0248586 A1	12/2004	Patel et al.
2003/0100334 A1	5/2003	Mazzara, Jr.	2004/0250212 A1	12/2004	Fish
2003/0101225 A1	5/2003	Han et al.	2004/0253964 A1	12/2004	Zhu
2003/0101341 A1	5/2003	Kettler, III et al.	2004/0254811 A1	12/2004	Horstemeyer
2003/0101450 A1	5/2003	Davidsson et al.	2004/0259641 A1	12/2004	Ho
2003/0104782 A1	6/2003	Wong et al.	2004/0267445 A1	12/2004	De Luca et al.
2003/0109245 A1	6/2003	McCalmont et al.	2005/0002419 A1	1/2005	Doviak et al.
2003/0119528 A1	6/2003	Pew et al.	2005/0015197 A1	1/2005	Ohtsuji et al.
2003/0126150 A1	7/2003	Chan	2005/0027666 A1	2/2005	Beck, Jr. et al.
2003/0134648 A1	7/2003	Reed	2005/0028034 A1	2/2005	Gantman et al.
2003/0148774 A1	8/2003	Naghian et al.	2005/0032527 A1	2/2005	Sheha et al.
2003/0149527 A1	8/2003	Sikila	2005/0038696 A1	2/2005	Kalevik et al.
2003/0153340 A1	8/2003	Crockett et al.	2005/0039140 A1	2/2005	Chen
2003/0153341 A1	8/2003	Crockett et al.	2005/0039178 A1	2/2005	Marolia et al.
2003/0153343 A1	8/2003	Crockett et al.	2005/0041578 A1	2/2005	Huotari et al.
2003/0163287 A1	8/2003	Vock et al.	2005/0043036 A1	2/2005	Toppe et al.
2003/0177058 A1	9/2003	Needham	2005/0043042 A1	2/2005	Hwang et al.
2003/0185357 A1	10/2003	Kaghazian	2005/0048948 A1	3/2005	Holland et al.
2003/0191682 A1	10/2003	Shepard et al.	2005/0048961 A1	3/2005	Ribaudo et al.
2003/0196105 A1	10/2003	Fineberg	2005/0049789 A1	3/2005	Kelly et al.
2003/0200128 A1	10/2003	Doherty	2005/0054352 A1	3/2005	Karaizman
2003/0200192 A1	10/2003	Bell et al.	2005/0054361 A1	3/2005	Turcanu et al.
2003/0210265 A1	11/2003	Haimberg	2005/0055374 A1	3/2005	Sato
2003/0216960 A1	11/2003	Postrel	2005/0060162 A1	3/2005	Mohit et al.
2003/0217150 A1	11/2003	Roese et al.	2005/0063563 A1	3/2005	Soliman
2003/0218539 A1	11/2003	Hight	2005/0065959 A1	3/2005	Smith et al.
2003/0220835 A1	11/2003	Barnes, Jr.	2005/0071702 A1	3/2005	Morisawa
2003/0223381 A1	12/2003	Schroderus	2005/0086261 A1	4/2005	Mammone
2004/0002359 A1	1/2004	Deas et al.	2005/0086467 A1	4/2005	Asokan et al.
2004/0010358 A1	1/2004	Oesterling et al.	2005/0090231 A1*	4/2005	Huberman et al. .... 455/411
2004/0010489 A1	1/2004	Rio	2005/0096042 A1	5/2005	Habeman et al.
2004/0019584 A1	1/2004	Greening et al.	2005/0096840 A1	5/2005	Simske
2004/0021567 A1	2/2004	Dunn	2005/0096978 A1	5/2005	Black
2004/0036649 A1	2/2004	Taylor	2005/0101314 A1	5/2005	Levi
2004/0044574 A1	3/2004	Cochran et al.	2005/0102098 A1	5/2005	Montealegre et al.
2004/0044623 A1	3/2004	Wake et al.	2005/0104976 A1	5/2005	Currans
			2005/0108643 A1	5/2005	Schybergson et al.
			2005/0112030 A1	5/2005	Gaus
			2005/0114527 A1	5/2005	Hankey et al.
			2005/0116027 A1	6/2005	Algiene et al.



(56)

References Cited

U.S. PATENT DOCUMENTS

2005/0120084 A1 6/2005 Hu et al.  
 2005/0125343 A1 6/2005 Mendelovich  
 2005/0134504 A1 6/2005 Harwood et al.  
 2005/0134578 A1 6/2005 Chambers et al.  
 2005/0143094 A1 6/2005 Reed et al.  
 2005/0144333 A1 6/2005 Kotzin  
 2005/0149443 A1 7/2005 Torvinen  
 2005/0153724 A1 7/2005 Vij et al.  
 2005/0154793 A1 7/2005 Khartabil et al.  
 2005/0169248 A1 8/2005 Truesdale et al.  
 2005/0171954 A1 8/2005 Hull et al.  
 2005/0174242 A1 8/2005 Cohen  
 2005/0176411 A1 8/2005 Taya et al.  
 2005/0185060 A1 8/2005 Neven et al.  
 2005/0186954 A1 8/2005 Kenney  
 2005/0192999 A1 9/2005 Cook et al.  
 2005/0198305 A1 9/2005 Pezaris et al.  
 2005/0202830 A1 9/2005 Sudit  
 2005/0202831 A1 9/2005 Sudit  
 2005/0202832 A1 9/2005 Sudit  
 2005/0202834 A1 9/2005 Sudit  
 2005/0203698 A1 9/2005 Lee  
 2005/0209815 A1 9/2005 Russon et al.  
 2005/0209995 A1 9/2005 Aksu et al.  
 2005/0210104 A1 9/2005 Torvinen  
 2005/0216457 A1 9/2005 Walther et al.  
 2005/0221843 A1 10/2005 Friedman et al.  
 2005/0222756 A1 10/2005 Davis et al.  
 2005/0222905 A1 10/2005 Wills  
 2005/0222961 A1 10/2005 Staib et al.  
 2005/0227705 A1\* 10/2005 Rousu et al. .... 455/456.1  
 2005/0228719 A1 10/2005 Roberts et al.  
 2005/0228853 A1 10/2005 Yamamura et al.  
 2005/0228860 A1 10/2005 Hamynen et al.  
 2005/0232252 A1 10/2005 Hoover  
 2005/0233776 A1 10/2005 Allen et al.  
 2005/0234891 A1 10/2005 Walther et al.  
 2005/0245232 A1 11/2005 Jakober et al.  
 2005/0250440 A1 11/2005 Zhou et al.  
 2005/0250516 A1 11/2005 Shim  
 2005/0251557 A1\* 11/2005 Yoshizawa et al. .... 709/206  
 2005/0255857 A1 11/2005 Kim et al.  
 2005/0256866 A1 11/2005 Lu  
 2005/0256867 A1 11/2005 Walther et al.  
 2005/0259675 A1 11/2005 Tuohino et al.  
 2005/0261829 A1 11/2005 Furukawa  
 2005/0262081 A1 11/2005 Newman  
 2005/0265318 A1 12/2005 Khartabil et al.  
 2005/0278749 A1 12/2005 Ewert et al.  
 2005/0282518 A1 12/2005 D'Evelyn et al.  
 2005/0286421 A1 12/2005 Janacek  
 2005/0288036 A1\* 12/2005 Brewer et al. .... 455/456.2  
 2005/0289097 A1 12/2005 Trossen et al.  
 2006/0003804 A1 1/2006 Liu  
 2006/0004834 A1 1/2006 Pyhalammi et al.  
 2006/0021009 A1 1/2006 Lunt  
 2006/0023747 A1 2/2006 Koren et al.  
 2006/0025071 A1 2/2006 Yamazaki et al.  
 2006/0030339 A1 2/2006 Zhovnirovsky et al.  
 2006/0030347 A1 2/2006 Biswaas  
 2006/0035647 A1 2/2006 Eisner et al.  
 2006/0036680 A1 2/2006 Shim  
 2006/0040676 A1 2/2006 Chen  
 2006/0040710 A1 2/2006 Ruetschi et al.  
 2006/0046761 A1 3/2006 Bishop et al.  
 2006/0047419 A1 3/2006 Diendorf et al.  
 2006/0047825 A1 3/2006 Steenstra et al.  
 2006/0052057 A1\* 3/2006 Persson et al. .... 455/41.2  
 2006/0053048 A1 3/2006 Tandetnik  
 2006/0053225 A1 3/2006 Poikselka et al.  
 2006/0058042 A1 3/2006 Shim  
 2006/0058955 A1 3/2006 Mehren  
 2006/0059023 A1 3/2006 Mashinsky  
 2006/0061488 A1 3/2006 Dunton  
 2006/0064346 A1 3/2006 Steenstra et al.

2006/0068753 A1 3/2006 Karpen et al.  
 2006/0079249 A1 4/2006 Shim  
 2006/0080286 A1 4/2006 Svendsen  
 2006/0085392 A1 4/2006 Wang et al.  
 2006/0085477 A1 4/2006 Phillips et al.  
 2006/0094353 A1 5/2006 Nielsen et al.  
 2006/0111944 A1 5/2006 Sirmans, Jr. et al.  
 2006/0128411 A1 6/2006 Turcanu  
 2006/0129451 A1 6/2006 Kohanim et al.  
 2006/0148490 A1 7/2006 Bates et al.  
 2006/0149606 A1 7/2006 Goan, Jr. et al.  
 2006/0150119 A1 7/2006 Chesnais et al.  
 2006/0170956 A1 8/2006 Jung et al.  
 2006/0174203 A1 8/2006 Jung et al.  
 2006/0174329 A1\* 8/2006 Dublsh ..... 726/4  
 2006/0179160 A1 8/2006 Uehara et al.  
 2006/0187227 A1 8/2006 Jung et al.  
 2006/0187228 A1 8/2006 Jung et al.  
 2006/0187230 A1 8/2006 Jung et al.  
 2006/0189337 A1 8/2006 Farrill et al.  
 2006/0190812 A1 8/2006 Ellenby et al.  
 2006/0211453 A1 9/2006 Schick  
 2006/0212558 A1 9/2006 Sahinoja et al.  
 2006/0212562 A1 9/2006 Kushwaha et al.  
 2006/0217127 A1 9/2006 Drane et al.  
 2006/0218175 A1 9/2006 Stuhec  
 2006/0218181 A1 9/2006 Jeon  
 2006/0221197 A1 10/2006 Jung et al.  
 2006/0224662 A1 10/2006 Richardson et al.  
 2007/0019614 A1 1/2007 Hoffmann  
 2007/0022011 A1 1/2007 Altberg et al.  
 2007/0041513 A1 2/2007 Gende  
 2007/0049288 A1 3/2007 Lamprecht et al.  
 2007/0121601 A1 5/2007 Kikinis et al.  
 2007/0202844 A1 8/2007 Wilson et al.  
 2007/0263560 A1 11/2007 Saarisalo et al.  
 2007/0276591 A1 11/2007 Lea et al.  
 2008/0046516 A1 2/2008 Hyoung et al.  
 2008/0086240 A1 4/2008 Breed  
 2008/0129528 A1 6/2008 Guthrie  
 2008/0287116 A1 11/2008 Drane et al.  
 2009/0019532 A1 1/2009 Jacobsen et al.  
 2009/0030605 A1 1/2009 Breed  
 2009/0047973 A1 2/2009 MacNaughtan et al.  
 2009/0197612 A1 8/2009 Kiiskinen  
 2009/0215465 A1 8/2009 Macnaughtan et al.  
 2010/0125498 A1 5/2010 Jaramillo  
 2011/0205054 A1 8/2011 Ioppe et al.  
 2011/0207479 A1 8/2011 Ioppe et al.  
 2014/0018102 A1 1/2014 Brewer et al.

FOREIGN PATENT DOCUMENTS

AU 2003903789 8/2003  
 AU 2004905077 9/2004  
 AU 2005901352 3/2005  
 AU 2005901353 3/2005  
 BR 9904979 A 12/2000  
 CA 2163215 11/1994  
 CA 2189515 A1 7/1997  
 CA 2287596 A1 4/2000  
 CA 2432239 A1 12/2004  
 DE 3621456 A1 1/1988  
 DE 4437360 A1 4/1996  
 DE 19506890 A1 8/1996  
 DE 19914257 A1 1/2000  
 DE 10141695 A1 3/2003  
 EP 288068 B1 7/1992  
 EP 0745867 A1 12/1996  
 EP 0763749 A1 3/1997  
 EP 0785535 A1 7/1997  
 EP 0786646 A2 7/1997  
 EP 0809117 A2 11/1997  
 EP 0813072 B1 12/1997  
 EP 699330 B1 4/1998  
 EP 0908835 A2 4/1999  
 EP 0997808 A2 5/2000  
 EP 1083764 B1 3/2001  
 EP 1300652 A2 4/2003

(56)

## References Cited

## FOREIGN PATENT DOCUMENTS

EP	1457928	A1	9/2004
EP	1465041	A2	10/2004
EP	1469287	A2	10/2004
EP	1496338	A2	1/2005
EP	1659817	A2	5/2006
FR	2730083	A1	8/1996
FR	2754093	A1	4/1998
FR	2810183	A1	12/2001
GB	2278196	A	11/1994
GB	2322248	A	8/1998
GB	2359888	A	9/2001
GB	0324800.2		10/2003
GB	2407230	A	4/2005
JP	62142215	A	6/1987
JP	05-071974		3/1993
JP	08-005394		1/1996
JP	08-069436		3/1996
JP	08-069436	A	3/1996
JP	08-510578		11/1996
JP	09-054895		2/1997
JP	09-054895	A	2/1997
JP	09-062993	A	3/1997
JP	04-354149		12/2004
JP	2005-006081		1/2005
JP	2006-260338		9/2006
KR	10-2004-0036490		5/2004
KR	2004-102440	A	12/2004
KR	10-2005-14287		2/2005
KR	2005-096746	A	10/2005
KR	10-2004-112991		7/2006
KR	10-2004-115411		7/2006
KR	2005-1675		7/2006
KR	10-2004-0064538		9/2006
KR	10-2005-0024544		9/2006
TW	2004-26387		12/2004
TW	2006-27985	A	6/2006
TW	93135920		6/2006
TW	94102945		6/2006
TW	93141508		7/2006
WO	93/20546		10/1993
WO	9320546	A1	10/1993
WO	94/08250		4/1994
WO	97/07467		2/1997
WO	9707467	A1	2/1997
WO	9854682	A1	12/1998
WO	9916036	A1	4/1999
WO	01/31966	A1	5/2001
WO	01/37597	A1	5/2001
WO	0208863	A2	1/2002
WO	02/054813	A1	7/2002
WO	03005747	A1	1/2003
WO	03009605	A2	1/2003
WO	03/023593	A1	3/2003
WO	03/096055	A2	11/2003
WO	2004/008792	A1	1/2004
WO	2004/021730	A1	3/2004
WO	2004/061576	A2	7/2004
WO	2004073217	A1	8/2004
WO	2004076977	A1	9/2004
WO	2004093348	A1	10/2004
WO	2005/006258	A1	1/2005
WO	2005038400	A1	4/2005
WO	2005052802	A1	6/2005
WO	2005/084052	A1	9/2005
WO	2006001412	A1	1/2006
WO	2006010977	A1	2/2006
WO	2006014439	A2	2/2006
WO	2006054340	A1	5/2006
WO	2006/065856	A1	6/2006
WO	2006108071	A2	10/2006
WO	2006108071	A3	10/2006
WO	2008065245		6/2008

## OTHER PUBLICATIONS

U.S. Appl. No. 60/046,021, filed May 9, 1997. First named inventor:

Clayton R. Karmel. Entitled, "Positioning system using packet radio to determine position and to obtain information relative to a position." U.S. Appl. No. 60/046,400, filed May 13, 1997. First named inventor: Scott R. Jamison. Entitled, "Automated touring information systems and methods." U.S. Appl. No. 60/058,623, filed Sep. 11, 1997. First named inventor: Harold L. Peterson. Entitled, "Software Vending, Delivery, and Maintenance System." U.S. Appl. No. 60/066,653, filed Nov. 19, 1997. First named inventor: Steven Baker. Entitled, "Method and apparatus for distributing location-based messages in a wireless communication network." U.S. Appl. No. 60/068,775, filed Dec. 24, 1997. First named inventor: Wendell Alumbaugh. Entitled, "Travel guide." U.S. Appl. No. 60/072,090, filed Jan. 21, 1998. First named inventor: Craig A. Owensby. Entitled, "Method of Subscriber-Targeted Advertising for Mobile Personal Communications Services." U.S. Appl. No. 60/072,757, filed Jan. 27, 1998. First named inventor: Steven M. Hoffberg. Entitled, "Mobile communication device." U.S. Appl. No. 60/097,932, filed Aug. 25, 1998. First named inventor: Matthew G. Pallakoff. Entitled, "System designed to facilitate team buying." U.S. Appl. No. 60/097,933, filed Aug. 25, 1998. First named inventor: Matt Pallakoff. Entitled, "Network system designed to facilitate offering, selling and purchasing goods and services." U.S. Appl. No. 60/105,493, filed Oct. 23, 1998. First named inventor: Raymond J. Menard. Entitled, "Low Power Two-Way Long Range Security System." U.S. Appl. No. 60/106,816 filed Nov. 3, 1998. First named inventor: James Fitch. Entitled, "Data Fusion for Wireless Location-Based Applications." U.S. Appl. No. 60/113,167, filed Dec. 21, 1998. First named inventor: Charles C. Cheng. Entitled, "Method for Location Based Asset Management." U.S. Appl. No. 60/115,074, filed Jan. 7, 1999. First named inventor: Harry E. Emerson, III. Entitled, "Enhanced Radio Graphic Data System." U.S. Appl. No. 60/123,821, filed Mar. 11, 1999. First named inventor: John D. Codignotto. Entitled, "Message publishing system and method." U.S. Appl. No. 60/123,882, filed Mar. 11, 1999. First named inventor: David S. Breed. Entitled, "Methods and Apparatus for Preventing Vehicle Accidents." U.S. Appl. No. 60/130,882, filed Apr. 23, 1999. First named inventor: Donald L. Fuchs. Entitled, "Method and Apparatus for Locating Mobile Receivers." U.S. Appl. No. 60/135,862, filed May 25, 1999. First named inventor: Raymond J. Menard. Entitled, "Bidirectional Wireless Detection System." U.S. Appl. No. 60/158,255, filed Oct. 5, 1999. First named inventor: Dave Michaelson, . Entitled, "Ocean Bottom Proximity Warning Sensor." U.S. Appl. No. 60/160,326, filed Oct. 19, 1999. First named inventor: Michael L. Obradovich. Entitled, "Technique for Effective Navigation Based on User Preferences." U.S. Appl. No. 60/162,333, filed Oct. 29, 1999. First named inventor: Hirohisa Tanaka. Entitled, "Method for Providing Matching and Introduction Services to Proximate Mobile Users and Service Providers." U.S. Appl. No. 60/165,435, filed Nov. 15, 1999. First named inventor: Jay S. Walker. Entitled, "Uniseller internet pricing." U.S. Appl. No. 60/170844, filed Dec. 14, 1999. First named inventor: Jhan. Entitled, "Improved Systems for Communication among Mobile Internet Users." U.S. Appl. No. 60/184248, filed Feb. 23, 2000. First named inventor: Robert M. Kalthoff. Entitled, "Locator system." U.S. Appl. No. 60/184,799, filed Feb. 24, 2000. First named inventor: Jay S. Walker. Entitled, "Redemption feedback loop for priceline for gas." U.S. Appl. No. 60/185,480, filed Feb. 28, 2000. First named inventor: C. Douglass Thomas. Entitled, "Method and System for Location Tracking."

(56)

## References Cited

## OTHER PUBLICATIONS

- U.S. Appl. No. 60/185,902, filed Feb. 29, 2000. First named inventor: John E. Boyd. Entitled, "A Computer-Based Networking Service and Method and Systems for Performing the Same."
- U.S. Appl. No. 60/186,155, filed Feb. 29, 2000. First named inventor: Blumberg; et al. Entitled, "Global positioning-based real estate database access device and method."
- U.S. Appl. No. 60/187,137, filed Mar. 6, 2000. First named inventor: Fisher; et al. Entitled, "ImageHub."
- U.S. Appl. No. 60/191,779, filed Mar. 24, 2000. First named inventor: Robert L. Piccioni. Entitled, "System and Method for Automated Distribution of Law Enforcement Information."
- U.S. Appl. No. 60/194,761, filed Apr. 3, 2000. First named inventor: Christopher Herringshaw. Entitled, "Method and Apparatus for Estimating Geographic Location of a Networked Entity."
- U.S. Appl. No. 60/196,575, filed Apr. 11, 2000. First named inventor: Michael Obradovich. Entitled, "GPS Publication Application Server."
- U.S. Appl. No. 60/199,528, filed Apr. 25, 2000. First named inventor: Todd Newville. Entitled, "Information Data Portal."
- U.S. Appl. No. 60/199,551, filed Apr. 25, 2000. First named inventor: Cooper. Entitled, "System and method for proximity searching position information using a proximity parameter."
- U.S. Appl. No. 60/202,147, filed May 5, 2000. First named inventor: Masoud Motamedi. Entitled, "Performance analysis tool for location systems."
- U.S. Appl. No. 60/205,938, filed May 18, 2000. First named inventor: Mathur; et al. Entitled, "System and method for creating content and preferences in a collaborative fashion with privacy."
- U.S. Appl. No. 60/210,682, filed Jun. 10, 2000. First named inventor: Hirohisa Tanaka. Entitled, "Method and System for Selectively Connecting Proximate Mobile Telecommunication Users Having Compatible Attributes."
- U.S. Appl. No. 60/210,691, filed Jun. 10, 2000. First named inventor: Geoffrey R. Hendrey. Entitled, "Method and System for Selectively Connecting Proximate Mobile Telecommunication Users."
- U.S. Appl. No. 60/212,155, filed Jun. 16, 2000. First named inventor: Tendler. Entitled, "Pager Activated GPS-Equipped Wireless Phone."
- U.S. Appl. No. 60/214,197, filed Jun. 26, 2000. First named inventor: Philip J. Koopman Jr. Entitled, "Method and Apparatus for Automatically Initiating Telecommunication Connections to Nearby Transceivers."
- U.S. Appl. No. 60/216,721, filed Jul. 7, 2000. First named inventor: Geoffrey R. Hendrey. Entitled, "Method and Apparatus for Facilitating Meetings Among Proximate Indirectly Related People."
- U.S. Appl. No. 60/218,454, filed Jul. 14, 2000. First named inventor: Norman Mohi. Entitled, "Locating system and method."
- U.S. Appl. No. 60/223,614, filed Aug. 7, 2000. First named inventor: Philip J. Koopman Jr. Entitled, "Method and System for Tracking Effectiveness of Mobile Telecommunication Advertisements."
- U.S. Appl. No. 60/225,076, filed Aug. 14, 2000. First named inventor: Ashutosh Pande. Entitled, "Multi-mode global positioning system for use with wireless networks."
- U.S. Appl. No. 60/228,102, filed Aug. 26, 2000. First named inventor: Thomas Black. Entitled, "Method and apparatus for restricting the assignment of VLANs."
- U.S. Appl. No. 60/241,776, filed Oct. 18, 2000. First named inventor: Brad Doctor. Entitled, "Method and System to Determine a Geographical Location Associated with a Network Address."
- U.S. Appl. No. 60/256,069, filed Dec. 15, 2000. First named inventor: Curtis A. Vock. Entitled, "Ubiquitous Movement Monitor Device."
- U.S. Appl. No. 60/257,386, filed Dec. 22, 2000. First named inventor: Curtis A. Vock. Entitled, "Movement Monitoring Systems and Methods."
- U.S. Appl. No. 60/259,271, filed Dec. 29, 2000. First named inventor: Curtis A. Vock. Entitled, "Movement Monitoring Systems and Methods."
- U.S. Appl. No. 60/264,164, filed Jan. 24, 2001. First named inventor: Yi-chung Chao. Entitled, "Methods and Implementation for Improving Mobile User Position Accuracy and Information Input/Output Formats."
- U.S. Appl. No. 60/471,743, filed May 20, 2003. First named inventor: Edmund J. Fish. Entitled, "Presence and Geo-Location Information for Mobile Devices and Computing Devices."
- U.S. Appl. No. 60/474,207, filed May 30, 2003. First named inventor: Stephen Vaughan Murphy. Entitled, "Spoken User Identifier."
- U.S. Appl. No. 60/480,532, filed Jun. 23, 2003. First named inventor: Ho, David YC. Entitled, "Game to Fame—An Internet Game that helps players become famous."
- U.S. Appl. No. 60/482,362, filed Jun. 25, 2003. First named inventor: Steve Kirchmeier. Entitled, "Telephony notification system."
- U.S. Appl. No. 60/488,399, filed Jul. 21, 2003. First named inventor: Andrew Weaver. Entitled, "Multiple Personalities."
- U.S. Appl. No. 60/488,638, filed Jul. 18, 2003. First named inventor: F. Craig Farrill. Entitled, "Real-Time Exchange."
- U.S. Appl. No. 60/488,784, filed Jul. 22, 2003. First named inventor: Kreft. Entitled, "Improved Information Mapping Program."
- U.S. Appl. No. 60/492,650, filed Aug. 5, 2003. First named inventor: Bruce D. Lawler. Entitled, "CDMA Press-to-Talk (P2T) Proof-of-Concept Demonstration."
- U.S. Appl. No. 60/493,704, filed Aug. 8, 2003. First named inventor: Michael A. Sheha. Entitled, "Method and System for Collecting, Synchronizing, and Reporting Telecommunication Call Events and Work Flow Related Information."
- U.S. Appl. No. 60/494,644, filed Aug. 11, 2003. First named inventor: Konstantin Othmer. Entitled, "Bandwidth Usage Optimization and Enhanced Performance for Wireless Networks."
- U.S. Appl. No. 60/503,260, filed Sep. 16, 2003. First named inventor: Steve Kirchmeier. Entitled, "Telephony notification system."
- U.S. Appl. No. 60/503,530, filed Sep. 16, 2003. First named inventor: William J. Sacco. Entitled, "Method and System of Rule-Based Triage."
- U.S. Appl. No. 60/507,110, filed Oct. 1, 2003. First named inventor: Robert Khedour. Entitled, "Portable internet-linked subscription-capable audio-visual player apparatus and system and method for distribution and use thereof."
- U.S. Appl. No. 60/512,852, filed Oct. 22, 2003. First named inventor: Patrick Blattner. Entitled, "Providing Video, Sound, or Animated Content with Instant Messages."
- U.S. Appl. No. 60/516,351, filed Oct. 31, 2003. First named inventor: Habeman, William E.; et al. Entitled, "Instantaneous Wireless Communicative Display and Interface System."
- U.S. Appl. No. 60/517,657, filed Nov. 5, 2003. First named inventor: Prabhakar R. Chitrapu. Entitled, "Mobile Wireless Presence and Situation Management System and Method."
- U.S. Appl. No. 60/518,333, filed Nov. 10, 2003. First named inventor: Uri Levi. Entitled, "Wireless communication system."
- U.S. Appl. No. 60/520,846, filed Nov. 18, 2003. First named inventor: Sugla. Entitled, "Method of Improving Location Accuracy, Achieving Seamless Tracking and Enabling Novel Applications Using Information From Multiple Location and Positioning Technologies."
- U.S. Appl. No. 60/522,490, filed Oct. 6, 2004. First named inventor: Otman A. Basir. Entitled, "Spatial Calendar."
- U.S. Appl. No. 60/524,343, filed Nov. 21, 2003. First named inventor: Poitras, Jean-Guy. Entitled, "Virtually Interlinked Collaborative Information System Based on Physical Locations of Tangible Real Property."
- U.S. Appl. No. 60/525,420, filed Nov. 25, 2003. First named inventor: Lars Eilstrup Rasmussen. Entitled, "System for automatically integrating a digital map system with world wide web sites."
- U.S. Appl. No. 60/528,055, filed Dec. 8, 2003. First named inventor: Doug Brams. Entitled, "Push to Talk User Interface."
- U.S. Appl. No. 60/530,935, filed Dec. 19, 2003. First named inventor: Brian E. Smartt. Entitled, "Geocoding locations near a specified city."
- U.S. Appl. No. 60/533,052, filed Dec. 30, 2003. First named inventor: Harper, et al. Entitled, "Universal Digital Music Licensing and Download System."
- U.S. Appl. No. 60/540,505, filed Jan. 29, 2004. First named inventor: Mark Hull. Entitled, "System and Method for Social Networking."

(56)

## References Cited

## OTHER PUBLICATIONS

- U.S. Appl. No. 60/543,105, filed Feb. 9, 2004. First named inventor: Julian Bourne. Entitled, "Method and Computer System for Social Networking."
- U.S. Appl. No. 60/544,209, filed Feb. 11, 2004. First named inventor: Richard Mgrdechian. Entitled, "Method and Apparatus for Wirelessly Communicating and Messaging Between Previously Known and Unknown Parties."
- U.S. Appl. No. 60/544,639, filed Feb. 13, 2004. First named inventor: Mark Hull. Entitled, "System and Method for Social Networking."
- U.S. Appl. No. 60/546,687, filed Feb. 20, 2004. First named inventor: Brian Roundtree. Entitled, "Call Intercept Methods for Customer Self Support and Methods for Navigating Data Screens."
- U.S. Appl. No. 60/549,484, filed Mar. 1, 2004. First named inventor: Richard Mgrdechian. Entitled, "Method and Apparatus for Wirelessly Communicating and Messaging Between Previously Known and Unknown Parties."
- U.S. Appl. No. 60/549,937, filed Mar. 5, 2004. First named inventor: Barry Appelman. Entitled, "Passive Population of Buddy List form a Contact List."
- U.S. Appl. No. 60/550,262, filed Mar. 3, 2004. First named inventor: Richard Mgrdechian. Entitled, "Method and Apparatus for Wirelessly Communicating and Messaging Between Previously Known and Unknown Parties."
- U.S. Appl. No. 60/550,300, filed Mar. 4, 2004. First named inventor: Tom Miltonberger. Entitled, "Method and System to Facilitate Geo-Location and Geo-Compliance Utilizing a Client Agent."
- U.S. Appl. No. 60/552,406, filed Mar. 10, 2004. First named inventor: Greg Tseng. Entitled, "Enhancing virally marketed facilities."
- U.S. Appl. No. 60/552,718, filed Mar. 15, 2004. First named inventor: Jeremy Liew. Entitled, "Social Networks."
- U.S. Appl. No. 60/553,240, filed Mar. 15, 2004. First named inventor: Isaias Sudit; and Title: "Telephone User Interface for Efficient Self-Location of Mobile Phone".
- U.S. Appl. No. 60/553,241, filed Mar. 15, 2004. First named inventor: Isaias, Sudit; and Title: "Meet Function for Telephone Auto Location System Based on Geographic Location and User Profiles".
- U.S. Appl. No. 60/555,501, filed Mar. 22, 2004. First named inventor: Jens Eilstrup Rasmussen. Entitled, "Sub-Pixel Bitmaps and Their Use in Generating, Storing and Displaying Maps."
- U.S. Appl. No. 60/560,087, filed Apr. 6, 2004. First named inventor: Cesar Cabral. Entitled, "Method and system for traffic management between a vehicle and a remote location."
- U.S. Appl. No. 60/560,468, filed Apr. 7, 2004. First named inventor: Brian Lawler. Entitled, "Trust-metric network methods and apparatus."
- U.S. Appl. No. 60/562,785, filed Apr. 15, 2004. First named inventor: Brian Wilson. Entitled, "System for Providing Location-Based Services in a Wireless Network, Such as Locating Sets of Desired Locations."
- U.S. Appl. No. 60/566,644, filed Apr. 29, 2004. First named inventor: John N. Gross. Entitled, "System & method of identifying and predicting innovation dissemination."
- U.S. Appl. No. 60/567,598, filed May 3, 2004. First named inventor: Klassen, Gerhard D. Entitled, "System and method for interrupt control on a handheld device."
- U.S. Appl. No. 60/567,946, filed May 3, 2004. First named inventor: Jens Eilstrup Rasmussen. Entitled, "An Image Tile-Based, Digital Mapping System for the World Wide Web."
- U.S. Appl. No. 60/568,482, filed May 6, 2004. First named inventor: Nathan Norfleet Eagle. Entitled, "Combined Short Range Radio Network and Cellular Telephone Network for Interpersonal Communications."
- U.S. Appl. No. 60/569,953, filed May 11, 2004. First named inventor: Ravi Ayyasamy. Entitled, "Press to Talk Client Application Programming Interface (PCAPI)."
- U.S. Appl. No. 60/570,410, filed May 12, 2004. First named inventor: Dennis P. Crowley. Entitled, "Location-Based Social Software for Mobile Devices."
- U.S. Appl. No. 60/571,075, filed May 14, 2004. First named inventor: Krishnakant Patel. Entitled, "Roaming Gateway for Support of Advanced Voice Services While Roaming."
- U.S. Appl. No. 60/573,059, filed May 21, 2004. First named inventor: Krishnakant Patel. Entitled, "SMSC Bypass (SB) for Expedited Presence Messaging."
- U.S. Appl. No. 60/573,780, filed May 24, 2004. First named inventor: Krishnakant Patel. "SIM Toolkit."
- "Buddy Locator." Jun. 11, 2003. [http://www.halfbakery.com/idea/Buddy\\_20Locator](http://www.halfbakery.com/idea/Buddy_20Locator).
- "Hansel and Gretel" a German folk tale recorded by the Brothers Grimm and published in 1812. Illustrated by Arthur Rackham in 1909. Specifically, we would like to cite the "white pebbles" and "bread crumbs" used as a form of tracking in the folk tale.
- "Mobile Phone Utility." Jan. 8, 2004. [http://www.halfbakery.com/idea/mobile\\_20phone\\_20utility](http://www.halfbakery.com/idea/mobile_20phone_20utility).
- "Mobile Proximity Link." Sep. 30, 2001. [http://www.halfbakery.com/idea/Mobile\\_20Proximity\\_20Link](http://www.halfbakery.com/idea/Mobile_20Proximity_20Link).
- "Networks in Motion Named Semi-Finalist for Wireless LBS Challenge." Mar. 18, 2004. <http://www.tmcnet.com/usubmit/2004/Mar/1025200.htm>.
- "Proposal for Free, Open Source Cell Phone Location Service." Mar. 6, 2004. [http://george.hotelling.net/90percent/geekery/proposal\\_for\\_free\\_open\\_source\\_cell\\_phone\\_location\\_service.php](http://george.hotelling.net/90percent/geekery/proposal_for_free_open_source_cell_phone_location_service.php).
- "SignalSoft Corporation Has Been Awarded a Location-Based Services Patent." Apr. 27, 2001. [http://www.cellular.co.za/news\\_2001/04282001-signalsoft-patent.htm](http://www.cellular.co.za/news_2001/04282001-signalsoft-patent.htm).
- "Star Trek Communicator" the prop utilized in the Star Trek television series. The first appearance was in "The Cage" episode airing in 1964. The Science Fiction series was created by Gene Roddenberry. Want, Roy et al. "The Active Badge Location System." Olivetti Research Ltd., Cambridge, England. ACM Transactions on Information Systems (TOIS), vol. 10, Issue 1. Jan. 1992. 10 pages.
- "The Tetra System." Ashcom Systems Ltd.—TETRA Communications Networks. Feb. 1, 2011. 2 pages.
- (Editor) Saint-Andre, Peter; (Contributors) Adachi, Shin et al. "Liberty ID-SIS Presence Service Specification." Version 1.0-10. Liberty Alliance Project. Copyright 2005. 14 pages.
- "Complete Coverage—Unrivalled coverage with Lower Costs." Nokia TB3 TETRA Base Station—Data Sheet. Copyright Nokia 2004. 2 pages.
- "Complete Nokia TETRA for Public Safety." Nokia Code: 11113. Copyright 2003 Nokia. 20 pages.
- Cuervo, F. et al. "Megaco Protocol Version 1.0." Network Working Group; Request for Comments: 3015; Obsoletes: 2885, 2886; Category: Standards Track. Copyright the Internet Society. Nov. 2000. 179 pages.
- Day, M. et al. "A Model for Presence and Instant Messaging." Network Working Group; Request for Comments: 2778; Category: Informational. Copyright the Internet Society. Feb. 2000. 17 pages.
- Groves, C. et al. "H.24B / MEGACO Registration Procedures." Network Working Group; Request for Comments: 5615; BCP:151; Category: Best Current Practice. Copyright IETF Trust and the persons identified as the document authors. Aug. 2009. 14 pages.
- "Improving TETRA Base Station Coverage with Revolutionary Radio Access Solution." White Paper. 0604 PMIR. Copyright Nokia 2004. 9 pages.
- Klyne, G. et al. "Date and Time on the Internet: Timestamps." Network Working Group; Request for Comments: 3339; Category: Standards Track. Copyright the Internet Society. Jul. 2002. 18 pages.
- Leighton, Paul "TETRA Security—2nd ETSI Security Workshop: Future Security." Jan. 16-17, 2007. Sophia-Antipolis, France. 31 pages.
- "Location Architecture Overview Requirements." Historic Version 1.0. "Open Mobile Alliance." OMA-RD-LOC\_ArchOverview-V1\_0-20041118-H. Nov. 18, 2004. 49 pages.
- Makelainen, Sami I. et al. "OMA IMPS (Previously Wireless Village)." A paper for instant messaging and presence-seminar, University of Helsinki. 2005. 12 pages.
- "Network Wide TETRA Services." Press Backgrounder for Nokia. Sep. 2004. Pages 1-3.
- "Nokia NetAct for TETRA—Ensuring a Reliable and Always Available Service." Copyright Nokia 2001. 2 pages.

(56)

## References Cited

## OTHER PUBLICATIONS

- "Operational Best Practices for Managing Trunked Land Mobile Radio Systems." PSWN—Public Safety Program Wireless Network. Final Version. May 2003. 77 pages.
- Salinas, Arturo. "Advantages and Disadvantages of Using Presence Service." Helsinki University of Technology. May 4-5, 2006. 8 pages.
- "TETRA is the Winner in Bahrain." Nokia TETRA is proving its worth in Bahrain, including the challenge of the first Middle Eastern Grand Prix. Copyright 2004. 2 pages.
- "TETRA Touch." Nokia TETRA customer newsletter. www.nokia.com/tetra\_touch. vol. 4. 2004. 28 pages.
- "What is TETRA?" TETRA Quick Guide. Press Background. Sep. 2004. 9 pages.
- Wireless Village—The Mobile IMPS Initiative. Client-Server Protocol Session and Transactions. Version 1.1. WV Internal Tracking No. WV-022. Copyright 2001-2002 Ericsson, Motorola and Nokia. Cover p. i-ii, pp. 1-92.
- Wireless Village—The Mobile IMPS Initiative. Command Line Protocol. Version 1.1. WV Internal Tracking No. WV-031. Copyright 2001-2002. Ericsson, Motorola and Nokia. Cover p. i-iii, pp. 1-31.
- Wireless Village—The Mobile IMPS Initiative. Presence Attributes. Version 1.1. WV Internal Tracking No. WV-029. Copyright 2001-2002. Ericsson, Motorola and Nokia. Cover p. i-ii, pp. 1-23.
- Wireless Village—The Mobile IMPS Initiative. SSP—Server to Server Protocol Semantics Document. Version 1.1. WV Internal Tracking No. WV-032. Copyright 2001-2002 Ericsson, Motorola and Nokia. Cover p. i-ix, pp. 1-125.
- Wireless Village—The Mobile IMPS Initiative. System Architecture Model. Version 1.1. WV Tracking No. WV-020. Copyright 2001-2002 Ericsson, Motorola and Nokia. Cover p. i-ii, pp. 1-10.
- "Wireless Village Initiative Announces Intent to Join the Open Mobile Alliance." Business, Wire (Vancouver, Canada), Business & High-Tech Editors. Jun. 13, 2002. 3 pages.
- "Location Based Services." GSM Association, Permanent Reference Document: SE.23. Version 3.1.0. Jan. 2003. 75 pages.
- "Location-Based Services System (LBSS)." 3GPP2 S.R0019 v 1.0.0. Stage 1 Description. 3rd Generation Partnership Project 2 "3GPP2." Sep. 22, 2000. 56 pages.
- "Senior Projects Garner Awards at Spring 2001 Design Expo." Department of Computer Science, University of Colorado at Boulder. 2004. 1 page.
- "The World in Your Hand." Newsweek. May 31, 1999. 1 page.
- Bahl, Paramvir et al. "Radar: An In-Building RF-based User Location and Tracking System." IEEE INFOCOM. 2000. pp. 775-784.
- Barkhuus, Louise. "Privacy in Location-Based Services, Concern vs. Coolness." Department of Design and Use of IT, The IT University of Copenhagen. Sep. 2004. 6 pages.
- Beresford, Alastair R. et al. "Location Privacy in Pervasive Computing." Published by the IEEE CS and IEEE Communications Society. Jan.-Mar. 2003. pp. 46-55.
- Bisdikian, C. et al. "Enabling Location-Based Services Through Passive Monitoring Techniques: Mobile Positioning with the HINTON Locator Probe." A White Paper from Telesoft Technologies, 1st Workshop on Mobile Commerce. 2001. pp. 1-20.
- Burak, Assaf et al. "Usage Patterns of FriendZone—Mobile Location-Based Community Services." MUM '04 Proceedings of the 3rd International Conference on Mobile and Ubiquitous Multimedia. 2004. 8 pages.
- Colbert, Martin. "A Diary Study of Rendezvousing: Implications for Position-Aware Computing and Communications for the General Public." Kingston University, Group '01. ACM Press. Sep. 30-Oct. 3, 2001. 10 pages.
- Cuellar, J. et al. "Geopriv Requirements." Internet Draft. Jun. 2002. pp. 1-23.
- Cuellar, J. et al. "Geopriv Requirements." Internet Draft. Nov. 2001. pp. 1-13.
- Dobson, Jerome E. et al. "Geoslavery." IEEE Technology and Society Magazine, Spring 2003. pp. 47-52.
- Gruteser, Marco et al. "Anonymous Usage of Location-Based Services Through Spatial and Temporal Cloaking." Department of Computer Science, University of Colorado at Boulder. Proc. MobiSys 2003, ACM Press. 12 pages.
- Jose, Rui et al. "Scalable and Flexible Location-Based Services for Ubiquitous Information Access." First International Symposium on Handheld and Ubiquitous Computing, HUC'99, Karlsruhe, Germany. Sep. 27-29, 1999. Published by Springer, Lecture Notes in Computer Science. vol. 1707. pp. 1-15.
- Kottman, Cliff. "Geospatial Sciences in support of Digital Government." Open GIS Consortium, Inc. Nov. 16, 2000. 36 pages.
- Davies; et al., "'Caches in the Air': Disseminating Tourist Information in the Guide System," Second IEEE Workshop on Mobile Computer Systems and Applications, Feb. 25-26, 1999, 9 pages.
- Drane and Rizos, "Role of Positioning Systems in ITS," Positioning Systems in Intelligent Transportation Systems, Dec. 1997, pp. 312, 346-349.
- Fischer; et al., "System Performance Evaluation of Mobile Positioning Methods," IEEE, Aug. 2002, pp. 1962-1966.
- Flinn and Satyanarayanan, "PowerScope: A Tool for Profiling the Energy Usage of Mobile Applications," Proc. WMCSA '99 Second IEEE Workshop on Mobile Computing Systems and Applications, Feb. 25-26, 1999, 9 pages.
- French and Driscoll, "Location Technologies for ITS Emergency Notification and E911," Proc. 1996 National Technical Meeting of the Institute of Navigation, Jan. 22-24, 1996, pp. 355-359.
- Friday; et al., "Developing Adaptive Applications: The MOST Experience," J. Integrated Computer-Aided Engineering, 1999, 35 pages.
- Gunnarsson; et al., "Location Trial System for Mobile Phones," IEEE, 1998, pp. 2211-2216.
- Kovacs; et al., "Adaptive Mobile Access to Context-aware Services," Proc. ASAMA '99 Proc. First International Symposium on Agent Systems and Applications Third International Symposium on Mobile Agents, IEEE Computer Society Washington, DC, 1999, 12 pages.
- Kugler and Lechner, "Combined Use of GPS and LORAN-C in Integrated Navigation Systems," Fifth International Conference on Satellite Systems for Mobile Communications and Navigation, London, UK, May 13-15, 1996, pp. 199-207.
- Kyriazakos; et al., "Optimization of the Handover Algorithm based on the Position of the Mobile Terminals," Communications and Vehicular Technology, Oct. 2000, pp. 155-159.
- Bennett; et al., "Location-based services", Mar. 1, 2002, Downloaded: Feb. 24, 2013, <http://www.ibm.com/developerworks/ibm/library/i-lbs/>, 7 pages.
- Persson; et al., "GeoNotes: a real-use study of a public location-aware community system (2002)", Dec. 2002, 10 pages.
- Munson; et al., "Location-based notification as a general-purpose service", Proceedings of the 2nd international workshop, WMC'02, Sep. 28, 2002, 5 pages.
- Stroud, "Minority Report Has Ad-ded Value", [online] Retrieved from the Internet on Mar. 3, 2013: URL: <http://www.wired.com/entertainment/music/news/2002/06/53555>, Jun. 29, 2002, 1 page.
- Barwise; et al., "Permission-Based Mobile Advertising", Journal of Interactive Marketing, vol. 16 / No. 1 / Winter 2002, pp. 14-24.
- Aalto; et al., "Bluetooth and WAP Push Based Location-Aware Mobile Advertising System", MobiSYS'04, Jun. 6-9, 2004, 10 pages.
- Kölmel; et al., "Location Based Advertising", The First International Conference on Mobile Business, M-Business Conference 2002, 7 pages.
- Bulander; et al., "Enabling Personalized and Context Sensitive Mobile Advertising While Guaranteeing Data Protection", Proceedings of the EURO-mGOV 2005, Brighton, UK Mobile Government International LLC, pp. 445-454.
- Rao; et al., "Evolution of Mobile Location-based Services", Communications of the ACM Dec. 2003/vol. 46, No. 12, pp. 61-65.
- Ko; et al., "Geocasting in Mobile Ad Hoc Networks: Location-Based Multicast Algorithms", International Conference on Mobile Computing and Networking, MobiCom'98, 1998, 10 pages.
- Varshney, "Location Management for Mobile Commerce Applications in Wireless Internet Environment", ACM Transactions on Internet Technology, vol. 3, No. 3, Aug. 2003, pp. 236-255.
- Ko; et al., "Location-Aided Routing (LAR) in mobile ad hoc networks", Wireless Networks 6 (2000), pp. 307-321.

(56)

## References Cited

## OTHER PUBLICATIONS

- Gratton, "M-commerce: The Notion of Consumer Consent in Receiving Location-Based Advertising", *Canadian Journal of Law & Technology*, vol. 1 No. 3, Nov. 2002, pp. 59-77.
- Corson; et al., "Mobile Ad hoc Networking (MANET): Routing Protocol Performance Issues and Evaluation Considerations", Request for Comments: 2501, The Internet Society, Jan. 1999, 12 pages.
- Perkins; et al., "Ad hoc On-Demand Distance Vector (AODV) Routing", Request for Comments: 3561, The Internet Society, Jul. 2003, 37 pages.
- Clausen; et al., "Optimized Link State Routing Protocol (OLSR)", Request for Comments: 3626, The Internet Society, Oct. 2003, 75 pages.
- Ogier; et al., "Topology Dissemination Based on Reverse-Path Forwarding (TBRPF)", Request for Comments: 3684, The Internet Society, Feb. 2004, 46 pages.
- Kaasinen, "User needs for location-aware mobile services", *Pers Ubiquit Comput* (2003), 7: pp. 70-79.
- Dimpfel; et al., "Integration and Content", ELBA (European Location Based Advertising), IST-2001-36530, 2002, 22 pages.
- "Location Based Advertising—Overview", ELBA (European Location Based Advertising), IST-2001-36530, Jun 30, 2002, 17 pages.
- Kölmel, "ELBA Location Based Advertising—Status", ELBA (European Location Based Advertising), IST-2001-36530, Sep. 2003, 21 pages.
- Porak, "ELBA Real Life scenarios of LBA"; *M-Business* 2003, Vienna 2003, 22 pages.
- Dimpfel, "Overview Technical Integration and Advertising Content Management", ELBA (European Location Based Advertising), IST-2001-36530, 2003, 8 pages.
- "ELBA—Project Summary", ELBA (European Location Based Advertising), 2002, 2 pages.
- U.S. Appl. No. 09/206,627, filed Dec. 7, 1998. First named inventor: Alvin C. Allen Jr. Entitled, "Apparatus and Method for Triggerable Location Reporting."
- U.S. Appl. No. 10/865,114, filed Jun. 9, 2004. First named inventor: Ricardo D. Craft. Entitled, "Aggregated Perceived Presence."
- U.S. Appl. No. 10/916,960, filed Aug. 11, 2004. First named inventor: Othmer; Konstantin. Entitled, "Systems and methods for populating a ticker with location-based content."
- U.S. Appl. No. 10/917,200, filed Aug. 11, 2004. First named inventor: Othmer. Entitled, "Bandwidth usage optimization and enhanced performance for wireless networks."
- U.S. Appl. No. 11/019,526, filed Dec. 23, 2004. First named inventor: Bill. Entitled, "Predicting an event at a location."
- U.S. Appl. No. 11/030,904, filed Jan. 10, 2005. First named inventor: Kurt Nosack. Entitled, "System and method for determining a nearest network resource using Gps coordinates."
- U.S. Appl. No. 11/063,096, filed Feb. 22, 2005. First named inventor: Ellenby; et al. Entitled, "Pointing systems for addressing objects."
- "U.S. Appl. No. 11/099,362, Non-Final Office Action mailed Aug. 28, 2006", 13 pgs.
- "U.S. Appl. No. 11/099,362, Notice of Allowance mailed Jun. 6, 2007", 7 pgs.
- "U.S. Appl. No. 11/099,362, Response Filed Jan. 29, 2007 to Non-Final Office Action mailed Aug. 28, 2006", 24 pgs.
- U.S. Appl. No. 09/365,748, filed Aug. 3, 1999. First named inventor: Michael David Bednarek. Entitled, "System and Method for Supporting Participant Specific Incentives and Promotions."
- U.S. Appl. No. 09/540,214, filed Mar. 31, 2000. First named inventor: Jay S. Walker. Entitled, "Method and apparatus for conducting a transaction based on brand indifference."
- U.S. Appl. No. 09/589,684, filed Jun. 7, 2000. First named inventor: Neeraj Jhanji. Entitled, "Improved Systems for Communicating Future Activity Information Among Mobile Internet Users and Methods Therefor."
- U.S. Appl. No. 09/589,685, filed Jun. 7, 2000. First named inventor: Neeraj Jhanji. Entitled, "Improved Systems for Communicating Future Activity Information Among Mobile Internet Users and Methods Therefor."
- Lamarca, Anthony et al. "Place Lab: Device Positioning Using Radio Beacons in the Wild." 2005. 18 pages.
- Mulligan, Morris et al. "Framework for Location Computation Scenarios." Internet-Draft. Nov. 2001. pp. 1-11.
- Priyantha, Nissanka B. "The Cricket Location-Support System." MIT Laboratory for Computer Science. The 6th ACM International Conference on Mobile Computing and Networking (ACM MOBICOM). Aug. 2000. 12 pages.
- Reed, Jeffrey H. et al. "An Overview of the Challenges and Progress in Meeting the E-911 Requirement for Location Service." *IEEE Communications Magazine*. Apr. 1998. pp. 30-37.
- Sen, Sumit. "Open Standards in Location Based Services." *Applied Technology Group, Tata Infotech Limited*. 2002. 6 pages.
- Abowd et al., "Cyberguide: A mobile context-aware tour guide." *Baltzer Journals*. Sep. 23, 1996. pp. 1-21.
- Kim H. Veltman "Frontiers in Electronic Media", *Interactions Journal of the ACM, New York, Jul.-Aug. 1997*, pp. 32-64.
- Henning Maass "Location-aware mobile applications based on directory services." *Mobile Networks and Applications* 3 (1998) 157-173.
- Sinclair "Integrating Hypermedia Techniques with Augmented Reality Environments" *University of Southampton*. Jun. 2004. pp. 1-155.
- Eija Kaasinen "User needs for location-aware mobile services." *Springer-Verlag London Limited*. Aug. 2002. pp. 70-79.
- Broadbent et al. "Location Aware Mobile Interactive Guides: usability issues." *Proceedings of the Fourth International Conference on Hypermedia and Interactivity in Museums. (ICHIM97) (Paris, 1997)*. pp. 1-15.
- "DaimlerCrysler Guide5 Usecases Overview Map." Oct. 2001. 1 page.
- "GPS 12 Personal Navigator™ Owner's Manual & Reference." *Garmin Corporation*. 1999. 66 pages.
- "Travel Time Data Collection Handbook—Chapter 5: ITS Probe Vehicle Techniques." *FHWS-PI98-035 Report, Department of Transport, University of Texas*. Mar. 1998. 70 pages.
- Hoogenraad "Location Dependent Services." 3rd AGILE Conference on Geographic Information Science, Helsinki/Espoo, Finland, May 2000. pp. 74-77.
- Balsiger et al., "MOGID: Mobile Geo-depended Information on Demand." *Workshop on Position Dependent Information Services (W3C-WAP)*, 2000, 8 pages.
- Efstratiou et al. "Reflection: A Solution for Highly Adaptive Mobile Systems," 2000 Workshop on Reflective Middleware, 2000, 2 pages.
- Popescu-Zeletin et al., "Applying Location-Aware Computing for Electronic Commerce: Mobile Guide" *Proc. 5th Conference on Computer Communications, AFRICOM-CCDC'98*, Oct. 20-22, 1998, 14 pages.
- Zhao, "Mobile Phone Location Determination and Its Impact on Intelligent Transportation Systems," *IEEE Transactions on Intelligent Transportation Systems*, Mar. 2000, 1(1):55-64.
- Popescu-Zeletin et al., "Applying Location-Aware Computing for Electronic Commerce: Mobile Guide," *Proc. 5th Conference on Computer Communications, AFRICOM-CCDC'98*, Oct. 20-22, 1998, 14 pages.
- Yokote, "The Apertos Reflective Operating System: The Concept and Its Implementation," *SCSL TR 92 014*, Jun. 26, 1992, 23 pages.
- Long et al., "Rapid Prototyping of Mobile Context-Aware Applications: The Cyberguide Case Study," *MobiCom '96*, 1996, 11 pages.
- Leonhardt et al., "Towards a general location service for mobile environments," *Proc. Third International Workshop on Services in Distributed and Networked Environments*, Jun. 3-4, 1996, 8 pages.
- Leonhardt et al., "Multi-Sensor Location Tracking," *MobiCom 98*, Dallas, TX, 12 pages.
- Kreller et al., "UMTS: A Middleware Architecture and Mobile API/Approach," *IAPRS*, vol. XXXIII, Amsterdam, 2000, 7 pages.
- Klinec and Volz, "Nexus-Positioning and Communication Environment for Spatially Aware Applications," *IAPRS*, vol. XXXIII, Amsterdam, 2000, 7 pages.
- "Digital cellular telecommunications system (Phase 2+); Specification of the SIM Application Toolkit for the Subscriber Identity Mod-

(56)

## References Cited

## OTHER PUBLICATIONS

- ule—Mobile Equipment (SIM—ME) interface (GSM 11.14)” Global System for Mobile Communications, Dec. 1996, 56 pages.
- “Estonian operator to launch world’s first Network-based location services,” Ericsson Press Release, Oct. 11, 1999, 1 page.
- Efstratiou et al., “Architectural Requirements for the Effective Support of Adaptive Mobile Applications,” 2000, 12 pages.
- Drane et al., “Positioning GSM Telephones,” IEEE Communications Magazine, Apr. 1998, pp. 46-59.
- Dix et al., “Exploiting Space and Location as a Design Framework for Interactive Mobile Systems,” ACM Transactions on Computer-Human Interaction (TOCHI)—Special issue on human-computer interaction with mobile systems, 2000, 36 pages.
- Davies et al., “‘Caches in the Air’: Disseminating Tourist Information in the Guide System,” Second IEEE Workshop on Mobile Computer Systems and Applications, Feb. 25-26, 1999, 9 pages.
- Davies et al., “L2imbo: A distributed systems platform for mobile computing,” Mobile Networks and Applications, 1998, 21 pages.
- Cheverst et al., “Supporting Collaboration in Mobile-aware Groupware,” Workshop on Handheld CSCW, 1998, 6 pages.
- Cheverst et al., “Sharing (Location) Context to Facilitate Collaboration Between City Visitors,” 2000, 5 pages.
- Cheverst et al., “Services to Support Consistency in Mobile Collaborative Applications,” Proc. 3rd International Workshop on Services in Distributed Networked Environments, 1996, 8 pages.
- Cheverst et al., “Experiences of Developing and Deploying a Context-Aware Tourist Guide: The Guide Project,” 2000, 12 pages.
- Cheverst et al., “Developing Interfaces for Collaborative Mobile Systems,” 1999, 15 pages.
- Cheverst et al., “Design of an Object Model for a Context Sensitive Tourist Guide,” 1999, 4 pages.
- Efstratiou et al., “Reflection: A Solution for Highly Adaptive Mobile Systems,” 2000 Workshop on Reflective Middleware, 2000, 2 pages.
- Cheverst et al., “The Role of Connectivity in Supporting Context-Sensitive Applications,” HUC’99, LNCS 1707, 1999, 15 pages.
- Cheverst et al., “Architectural Ideas for the Support of Adaptive Context-Aware Applications,” Proceedings of Workshop on Infrastructure for Smart Devices—How to Make Ubiquity an Actuality, HUC’00, Bristol, Sep. 2000, 3 pages.
- Balsiger et al., “MOGID: Mobile Geo-depended Information on Demand.” [online] Retrieved from the Internet on May 25, 2012: URL: <http://www.w3.org/Mobile/posdep/wap-v2.htm>, Workshop on Position Dependent Information Services (W3C-WAP), 2000, 9 pages.
- Borsodi, “Super Resolution of Discrete Arrivals in a Cellular Geolocation System,” University of Calgary Thesis, Apr. 2000, 164 pages.
- Akerblom, “Tracking Mobile Phones in Urban Areas,” Goteborg University Thesis, Sep. 2000, 67 pages.
- Digital cellular telecommunications system (Phase 2+); Location Services (LCS); Service description, Stage 1 (GSM 02.71) ETSI, Apr. 1999, 22 pages.
- “3rd Generation Partnership Project (3GPP); Technical Specification Group (TSG) RAN; Working Group 2 (WG2); Report on Location Services,” TS RAN R2.03 V0.1.0, Apr. 21-23, 1999, 43 pages.
- “Enabling UMTS/Third Generation Services and Applications,” No. 11 Report from the UMTS Forum, Oct. 2000, 72 pages.
- “3rd Generation Partnership Project; Technical Specification Group Radio Access Network; Stage 2 Functional Specification of Location Services in UTRAN,” 3G TS 25.305 v.3.1.0, Mar. 2000, 47 pages.
- “3rd Generation Partnership Project; Technical Specification Group Services and System Aspects; Functional stage 2 description of location services in UMTS,” 3G TS 23.171 v.3.1.0, 1999, 55 pages.
- U.S. Appl. No. 60/574,988, filed May 26, 2004. First named inventor: Randolph A. Jaramillo. Entitled, “Hot-Merchant Network (Mobile-Commerce or M-Merchant Network).”
- U.S. Appl. No. 60/576,092, filed Jun. 2, 2004. First named inventor: Krishnakant Patel. Entitled, “Pre-Provisioning for P2T Over the Air Activation.”
- U.S. Appl. No. 60/576,094, filed Jun. 2, 2004. First named inventor: F. Craig Farrill. Entitled, “Technique for Zero Delay Call Set-Up in Press to Talk (P2T) Systems.”
- U.S. Appl. No. 60/577,971, filed Jun. 8, 2004. First named inventor: Dan Illowsky. Entitled, “Architecture, Apparatus and Methods Thereof for an Efficient Low Cost Seamless Device Interoperability Software Platform.”
- U.S. Appl. No. 60/579,309, filed Jun. 14, 2004. First named inventor: Ravi Ayyasamy. Entitled, “Client Specification and Architecture for Supporting Press to Talk and Other Premium Voice Services in Wireless Networks.”
- U.S. Appl. No. 60/579,322, filed Jun. 15, 2004. First named inventor: Ahmad, Ahmad M. Entitled, “Method and system for Modeling People Traveling Behavior.”
- U.S. Appl. No. 60/581,466, filed Jun. 21, 2004. First named inventor: Arianna Bassoli. Entitled, “Synchronized media streaming between distributed peers.”
- U.S. Appl. No. 60/581,954, filed Jun. 22, 2004. First named inventor: F. Craig Farrill. Entitled, “Press-to-Connect (PTC) for Wireless Communications Systems.”
- U.S. Appl. No. 60/582,280, filed Jun. 22, 2004. First named inventor: Tony F. Rodriguez. Entitled, “Digital asset management and targeted searching using digital watermarks.”
- U.S. Appl. No. 60/582,313, filed Jun. 23, 2004. First named inventor: Julian Bourne. Entitled, “Method and System for Identifying, Locating and Contacting Like-Minded People.”
- U.S. Appl. No. 60/588,464, filed Jul. 16, 2004. First named inventor: Deepankar Biswas; and Title: “Virtual Push to Talk (PTT) and Push to Share (PTS)”
- U.S. Appl. No. 60/590,152, filed Jul. 21, 2004. First named inventor: Brian Roundtree. Entitled, “Mobile Device Assistance, Mobile Device Management, and Call Interceptor for Mobile Devices.”
- U.S. Appl. No. 60/592,838, filed Jul. 30, 2004. First named inventor: David S. Breed. Entitled, “System for obtaining vehicular information.”
- U.S. Appl. No. 60/595,805, filed Aug. 4, 2004. First named inventor: Igor Zhovnirovsky. Entitled, “System for Implementing Serverless Applications Over the Public Wireless Network.”
- U.S. Appl. No. 60/602,642, filed Aug. 19, 2004. First named inventor: Harper; Gregory W. Entitled, “Digital Music Download.”
- U.S. Appl. No. 60/605,345, filed Aug. 27, 2004. First named inventor: Scott Shamp. Entitled, “Wireless communication of context sensitive content, systems methods and computer program product.”
- U.S. Appl. No. 60/605,498, filed Aug. 31, 2004. First named inventor: William Meadow. Entitled, “Video and data processing system.”
- U.S. Appl. No. 60/606,590, filed Sep. 2, 2004. First named inventor: Diendorf; John R.; et al. Entitled, “Telematic method and apparatus for managing shipping logistics.”
- U.S. Appl. No. 60/609,948, filed Sep. 15, 2004. First named inventor: Phil Stanhope. Entitled, “System and method for synchronizing data.”
- U.S. Appl. No. 60/609,989, filed Sep. 15, 2004. First named inventor: John Landry. Entitled, “System and method for sharing content.”
- U.S. Appl. No. 60/609,990, filed Sep. 15, 2004. First named inventor: John Landry. Entitled, “System and method for linking data.”
- U.S. Appl. No. 60/610,016, filed Sep. 15, 2004. First named inventor: Phil Stanhope. Entitled, “System and method for sharing content.”
- U.S. Appl. No. 60/610,079, filed Sep. 15, 2004. First named inventor: Phil Stanhope. Entitled, “System and method for auditing data.”
- U.S. Appl. No. 60/611,607, filed Sep. 21, 2004. First named inventor: Brian Roundtree. Entitled, “Secure Mobile Device Software Execution, Help-Support-Care Initiation for Mobile Devices, and Smart Network Configuration Selection for Mobile Devices.”
- U.S. Appl. No. 60/613,646, filed Sep. 27, 2004. First named inventor: Morris Lee. Entitled, “Methods and apparatus for using location information to manage spillover in an audience monitoring system.”
- U.S. Appl. No. 60/614,939, filed Sep. 29, 2004. First named inventor: Morris Lee. Entitled, “Methods and apparatus for using location information to manage spillover in an audience monitoring system.”
- U.S. Appl. No. 60/618,201, filed Oct. 12, 2004. First named inventor: Wendy Wan-Lin Yang. Entitled, “Systems and methods for managing and presenting entity information.”

(56)

## References Cited

## OTHER PUBLICATIONS

- U.S. Appl. No. 60/618,748, filed Oct. 15, 2004. First named inventor: Blumberg; et al. Entitled, "Mobile location aware search engine and method of providing content for same."
- U.S. Appl. No. 60/620,456, filed Oct. 19, 2004. First named inventor: Rosen; James S. Entitled, "System and method for location based social networking."
- U.S. Appl. No. 60/622,797, filed Oct. 29, 2004. First named inventor: Bill. Entitled, "Dynamically Predicting an Event at a Location."
- U.S. Appl. No. 60/623,108, filed Oct. 29, 2004. First named inventor: Edward James Morgan. Entitled, "Wireless data Scanning Network for Building Location Beacon Database."
- U.S. Appl. No. 60/624,281, filed Jan. 29, 2005. First named inventor: Ching-Fang Lin. Entitled, "Interruption free navigator."
- U.S. Appl. No. 60/625,467, filed Nov. 5, 2004. First named inventor: Houston Staton. Entitled, "Method and System for Remote Monitoring and Control of Movable Entities."
- U.S. Appl. No. 60/626,573, filed Nov. 10, 2004. First named inventor: Chung, Wing Yeung ; et al. Entitled, "Locomotive wireless video recorder and recording system."
- U.S. Appl. No. 60/626,977, filed Nov. 12, 2004. First named inventor: Lyn Seidler. Entitled, "System and method for automated friend-to-friend delivery item."
- U.S. Appl. No. 60/627,785, filed Nov. 12, 2004. First named inventor: Gagan Puranik. Entitled, "Two-way messaging with encryption."
- U.S. Appl. No. 60/629,721, filed Nov. 19, 2004. First named inventor: Wong; Raymond et al. Entitled, "Bid Write-Up."
- U.S. Appl. No. 60/631,602, filed Nov. 30, 2004. First named inventor: Jeffrey Lynn Meckley. Entitled, "Phase persistent agile signal source."
- U.S. Appl. No. 60/631,876, filed Dec. 1, 2004. First named inventor: Barry Appelman. Entitled, "Automatically Enabling the Forwarding of Instant Messages."
- U.S. Appl. No. 60/634,951, filed Dec. 10, 2004. First named inventor: Andre Gueziec. Entitled, "Real-time and predictive traveler information for routing."
- U.S. Appl. No. 60/635,856, filed Dec. 13, 2004. First named inventor: Dan Burkhart. Entitled, "Instant Messaging Method and Apparatus."
- U.S. Appl. No. 60/636,953, filed Dec. 17, 2004. First named inventor: Coch; et al. Entitled, "Geo-Collaboration System."
- U.S. Appl. No. 60/639267, filed Dec. 27, 2004. First named inventor: Andrew Levi. Entitled, "Method and system for peer-to-peer advertising between mobile devices."
- U.S. Appl. No. 60/643,721, filed Jan. 13, 2005. First named inventor: Baowei Ji. Entitled, "Medium access control (MAC) protocol for use in ad hoc wireless networks."
- U.S. Appl. No. 60/647,897, filed Jan. 28, 2005. First named inventor: Baowei Ji. Entitled, "Asynchronous wireless collision detection with acknowledgment for use in ad hoc wireless networks."
- U.S. Appl. No. 60/649,180, filed Feb. 3, 2005. First named inventor: Cyril Hourri. Entitled, "System and Method for Geographically Locating Computing Devices in a Wireless Network."
- U.S. Appl. No. 60/650,840, filed Feb. 7, 2005. First named inventor: Jens Eilstrup Rasmussen. Entitled, "Method and Apparatus for Generating Tiles in a Digital Mapping System."
- U.S. Appl. No. 60/652,144, filed Feb. 11, 2005. First named inventor: Brian Roundtree. Entitled, "Call Intercept Methods, Such as for Customer Self-Support on a Mobile Device."
- U.S. Appl. No. 60/654,271, filed Feb. 18, 2005. First named inventor: Krishnakant Patel. Entitled, "Enhanced Features on an Advanced Voice Services (AVS) Framework."
- U.S. Appl. No. 60/654,811, filed Feb. 22, 2005. First named inventor: Edward James Morgan. Entitled, "Continuous Data Optimization in Positioning System."
- U.S. Appl. No. 60/654,951, filed Feb. 23, 2005. First named inventor: Harper; Gregory W . Entitled, "Systems and Methods for Storing Digital Content on Portable Devices."
- U.S. Appl. No. 60/656,642, filed Feb. 25, 2005. First named inventor: Tony F. Rodriguez. Entitled, "Digital asset management, targeted searching and desktop searching using digital watermarks."
- U.S. Appl. No. 60/657,222, filed Feb. 28, 2005. First named inventor: Ian Rogers. Entitled, "A System and Method for Delivering Media over a Network"
- U.S. Appl. No. 60/658,086, filed Mar. 3, 2005. First named inventor: Michael Keith Dery. Entitled, "Cellular Telephone Tracking System Employing a GPS Receiver."
- U.S. Appl. No. 60/658,312, filed Mar. 3, 2005. First named inventor: Andre Gueziec. Entitled, "7-Day traffic forecasts and trip advice."
- U.S. Appl. No. 60/658,328, filed Mar. 2, 2005. First named inventor: Robertson; et al. Entitled, "System and method for managing user interaction data in a networked environment."
- U.S. Appl. No. 60/659,643, filed Mar. 5, 2005. First named inventor: Sheha; Michael A.; et al. Entitled, "Method and System for Identifying and Defining Geofences."
- U.S. Appl. No. 60/660,111, filed Mar. 8, 2005. First named inventor: Ching-Fang Lin. Entitled, "Interruption free navigator"
- U.S. Appl. No. 60/661,056, filed Mar. 13, 2005. First named inventor: Kevin McKenzie. Entitled, "Method and System for Providing Security During Data Transmission over Wireless and Wired Network Connections."
- U.S. Appl. No. 60/666,424, filed Mar. 30, 2005. First named inventor: Krishnakant Patel. Entitled, "Technique for Implementing Advanced Voice Services Using an Unstructured Supplementary Service Data (USSD) Interface."
- U.S. Appl. No. 60/667,491, filed Apr. 1, 2005. First named inventor: Ching-Fang Lin. Entitled, "Interruption free navigator"
- U.S. Appl. No. 60/170,914, filed Dec. 15, 1999. First named inventor: Semyon Dukach. Entitled, "Apparatuses Methods and Computer Programs for Displaying Information on Signs."
- U.S. Appl. No. 60/196,099, filed Apr. 11, 2000. First named inventor: Dara Ung. Entitled, "Wireless chat status tracking."
- U.S. Appl. No. 60/196,104, filed Apr. 11, 2000. First named inventor: Erik Wallace. Entitled, "Mobile activity status tracker."
- U.S. Appl. No. 60/382,909, filed May 22, 2002. First named inventor: Myra Hight. Entitled, "Child locator system."
- U.S. Appl. No. 60/387,482, filed Jun. 10, 2002. First named inventor: Suman Beros. Entitled, "Method and apparatus for effecting a detection of mobile devices that are proximate and exhibit commonalities between specific data sets associated with each mobile device."
- U.S. Appl. No. 60/400,603, filed Aug. 2, 2002. First named inventor: Alex Mashinsky. Entitled, "Method, system and apparatus for providing transportation service."
- U.S. Appl. No. 60/473,738, filed May 28, 2003. First named inventor: Scott A. Horstemeyer. Entitled, "Advertisement business methods for notification systems."
- U.S. Appl. No. 60/473,742, filed May 28, 2003. First named inventor: Scott A. Horstemeyer. Entitled, "Response systems and methods for notification systems for modifying future notifications."
- U.S. Appl. No. 60/473,949, filed May 28, 2003. First named inventor: Scott A. Horstemeyer. Entitled, "Response systems and methods for notification systems."
- U.S. Appl. No. 60/486,768, filed Jul. 11, 2003. First named inventor: Scott A. Horstemeyer. Entitled, "Stop location determination systems and methods based upon user-defined timing criteria."
- U.S. Appl. No. 60/498,084, filed Aug. 27, 2003. First named inventor: Charles S. Ribaldo. Entitled, "System and method for personal area matching."
- U.S. Appl. No. 60/498,819, filed Aug. 29, 2003. First named inventor: Scott A. Horstemeyer. Entitled, "Notification systems and methods enabling a response to change particulars of a delivery or pickup."
- U.S. Appl. No. 60/540,346, filed Feb. 2, 2004. First named inventor: Philip E. Cohen. Entitled, "Monitoring method and system."
- U.S. Appl. No. 60/547,509, filed Feb. 25, 2004. First named inventor: Charles S. Ribaldo. Entitled, "Personal area matching."
- U.S. Appl. No. 60/563,639, filed Apr. 20, 2004. First named inventor: Keith A. Krefl. Entitled, "Information mapping methods, systems and applications."
- U.S. Appl. No. 60/611,801, filed Sep. 22, 2004. First named inventor: Jim Karpen. Entitled, "Emergency call handling system."
- U.S. Appl. No. 60/621,345, filed Oct. 22, 2004. First named inventor: Purva R. Rajkotia. Entitled, "System and method for provisioning broadcast and multicast services in a wireless network."



(56)

## References Cited

## OTHER PUBLICATIONS

- U.S. Appl. No. 60/631,293, filed Nov. 24, 2004. First named inventor: Gregory J. Winter. Entitled, "Mobile resource management system."
- U.S. Appl. No. 60/650,927, filed Feb. 8, 2005. First named inventor: Michael F. Gende. Entitled, "Procedures for provisioning and routing 9-1-1 voice over IP (VoIP) and/or wireless voice calls to the proper public safety answering point (PSAP)."
- U.S. Appl. No. 60/655,230, filed Feb. 22, 2005. First named inventor: Kathy Pierce. Entitled, "Geographic redundancy or back up switch."
- U.S. Appl. No. 60/657,560, filed Feb. 28, 2005. First named inventor: Thomas Breen. Entitled, "Methods and systems for foreign call back number compatibility for VoIP E 9-1-1 calls."
- U.S. Appl. No. 60/658,223, filed Mar. 3, 2005. First named inventor: Robert F. Crompt. Entitled, "Incident command system."
- U.S. Appl. No. 60/661,506, filed Mar. 15, 2005. First named inventor: Rakesh Kushwaha. Entitled, "System and method for monitoring and measuring end-to-end performance using wireless devices."
- U.S. Appl. No. 60/661,507, filed Mar. 15, 2005. First named inventor: Rakesh Kushwaha. Entitled, "System and method for trap management and monitoring on wireless terminals."
- U.S. Appl. No. 60/668,242, filed Apr. 4, 2005. First named inventor: Hermann Schulte-Kellinghaus. Entitled, "Home zone solution using radio frequency identification (RFID) technology."
- U.S. Appl. No. 09/494,553, filed Jan. 31, 2000. First named inventor: James M. Zombek. Entitled, "Messaging method and apparatus for sending and receiving messages in a client server environment over multiple wireless networks."
- U.S. Appl. No. 09/694,297, filed Oct. 24, 2000. First named inventor: James M. Zombek. Entitled, "Messaging method and apparatus for sending and receiving messages in a client server environment over multiple wireless and wireline networks."
- Huff, "Macro Management: New Advancements in Wireless Technology Automate Driver Input and Turn Volumes of Vehicle and Driver Data Into Byte-Size Pieces That Help Drivers and Managers Alike," Commercial carrier journal for professional fleet managers. May 2003, vol. 169 No. 5, pp. 36-40.
- U.S. Appl. No. 60/266,559, filed Feb. 5, 2001. First named inventor: Athanasios Diacakis. Entitled, "Presence and availability management system."
- U.S. Appl. No. 60/268,473, filed Feb. 12, 2001. First named inventor: Woody Denman. Entitled, "SIP-Based Push-to-Talk (PTT) Service."
- U.S. Appl. No. 60/269,506, filed Feb. 16, 2001. First named inventor: Kevin Buckham. Entitled, "Monitoring and controlling access to wireless location information for group based and other applications."
- U.S. Appl. No. 60/274,453, filed Mar. 9, 2001. First named inventor: Heikki Huomo. Entitled, "System, mobile station and method for managing context-related information."
- U.S. Appl. No. 60/277,347, filed Mar. 19, 2001. First named inventor: Fano, Andrew E.; et al. Entitled, "Mobile valet."
- U.S. Appl. No. 60/279,401, filed Mar. 28, 2001. First named inventor: Raymond J. Menard. Entitled, "Variable Distance RF Tag Disclosure."
- U.S. Appl. No. 60/279,513, filed Mar. 28, 2001. First named inventor: Raymond J. Menard. Entitled, "Range and Bearing Indicator for Wireless Device."
- U.S. Appl. No. 60/279,671, filed Mar. 30, 2001. First named inventor: H. Britton Sanderford Jr. Entitled, "Enhanced wireless packet data communication system, method and apparatus applicable to both wide area networks and local area networks."
- U.S. Appl. No. 60/281,038, filed Apr. 2, 2001. First named inventor: Fano, Andrew E.; et al. Entitled, "Mobile valet."
- U.S. Appl. No. 60/282,205, filed Apr. 6, 2001. First named inventor: Kevin C. Jones. Entitled, "Digital asset management and linking media signals with related data using watermarks."
- U.S. Appl. No. 60/283,929, filed Apr. 17, 2001. First named inventor: Steinbach, Galia ; et al. Entitled, "Beyondguide™ method and system."
- U.S. Appl. No. 60/285,032, filed Apr. 19, 2001. First named inventor: Curtis A. Vock. Entitled, "Event Monitoring Systems and Methods."
- U.S. Appl. No. 60/286,916, filed Apr. 27, 2001. First named inventor: Eric A. Portman. Entitled, "Location Based Services."
- U.S. Appl. No. 60/289,586, filed May 9, 2001. First named inventor: Philip Klein. Entitled, "Preprocessing an Undirected Planar Network to Enable Fast Approximate Distance Queries."
- U.S. Appl. No. 60/301,567, filed Jun. 28, 2001. First named inventor: Woody Denman. Entitled, "SIP-Based Push-to-Talk (PTT) Service."
- U.S. Appl. No. 60/303,019, filed Jul. 5, 2001. First named inventor: Priya Viswanath. Entitled, "Passively tracking mobile subscribers by monitoring wireless network messages."
- U.S. Appl. No. 60/303,615, filed Jul. 6, 2001. First named inventor: Randolph A. Jaramillo. Entitled, "Systems for Solving Challenges in Telecom Sales and Marketing."
- U.S. Appl. No. 60/305,580, filed Jul. 16, 2001. First named inventor: Scott Notes. Entitled, "Dynamic Polling Optimization Server."
- U.S. Appl. No. 60/305,975, filed Jul. 17, 2001. First named inventor: Sheha; et al. Entitled, "Position determination system."
- U.S. Appl. No. 60/313,010, filed Aug. 20, 2001. First named inventor: Sheha; et al. Entitled, "Point of interest spatial rating search method and system."
- U.S. Appl. No. 60/318,738, filed Sep. 12, 2001. First named inventor: Daubed; et al. Entitled, "High resolution tracking of mobile assets."
- U.S. Appl. No. 60/319,162, filed Apr. 2, 2002. First named inventor: Randazzo. Entitled, "NAV-Cell Pier to Pier GPS."
- U.S. Appl. No. 60/319,769, filed Dec. 11, 2002. First named inventor: Randazzo. Entitled, "Marine GPScell."
- U.S. Appl. No. 60/323,601, filed Sep. 20, 2001. First named inventor: Curtis A. Vock. Entitled, "Event Monitoring Systems and Methods."
- U.S. Appl. No. 60/327,327, filed Oct. 4, 2001. First named inventor: Stephen Michael Palik. Entitled, "Machine for providing a dynamic database of geographic location information for a plurality of wireless communications device and process for making same."
- U.S. Appl. No. 60/335,203, filed Oct. 23, 2001. First named inventor: Mark J. Reed. Entitled, "Machine for providing a directional assistance network and process for same."
- U.S. Appl. No. 60/337,945, filed Nov. 9, 2001. First named inventor: McCarthy; et al. Entitled, "Network text messaging organized by threads."
- U.S. Appl. No. 60/349,251, filed Jan. 18, 2002. First named inventor: Larry Lu. Entitled, "Calendar Overlays."
- U.S. Appl. No. 60/351,935, filed Jan. 24, 2002. First named inventor: Ryan Steelberg. Entitled, "RF Delivery."
- U.S. Appl. No. 60/352,761, filed Jan. 29, 2002. First named inventor: Mark Jefferson Reed. Entitled, "Mchine for providing a wireless communications device location tracking system and process for making same."
- U.S. Appl. No. 60/354,284, filed Feb. 1, 2002. First named inventor: Priestersbach; et al. Entitled, "Integrating context information into enterprise applications for mobile applications."
- U.S. Appl. No. 60/357,240, filed Feb. 14, 2002. First named inventor: Andrew Charles Zmolek. Entitled, "Presence Tracking and Namespace Interconnection Techniques."
- U.S. Appl. No. 60/359,792, filed Feb. 26, 2002. First named inventor: Scott Notes. Entitled, "Minimizing Mobile Location Lookups via Intelligent Scheduling."
- U.S. Appl. No. 60/359,793, filed Feb. 26, 2002. First named inventor: Scott Notes. Entitled, "Computing Location Updates for Applications Requiring Location-Based Triggering."
- U.S. Appl. No. 60/360,527, filed Feb. 28, 2002. First named inventor: Phillip Klein. Entitled, "System for Multi-User Location Based Alerts."
- U.S. Appl. No. 60/360,737, filed Mar. 1, 2002. First named inventor: Michael A. Sheha. Entitled, "Method and Apparatus for Sending, Retrieving, and Planning Location Relevant Information."
- U.S. Appl. No. 60/361,380, filed Mar. 1, 2002. First named inventor: Richard W. Graham. Entitled, "A System and Method to Provide Security in a Network Based on Device Location Information."
- U.S. Appl. No. 60/361,419, filed Mar. 1, 2002. First named inventor: John J. Roesse. Entitled, "A System for Network Definition Based on Device Location."
- U.S. Appl. No. 60/361,420, filed Mar. 1, 2002. First named inventor: Richard W. Graham. Entitled, "Systems and Methods to Define Location of a Network Device or a Networked Device."

(56)

## References Cited

## OTHER PUBLICATIONS

- U.S. Appl. No. 60/361,421, filed Mar. 1, 2002. First named inventor: John J. Roese. Entitled, "A System to Regulate Access as a Function of Device Location."
- U.S. Appl. No. 60/362,155, filed Mar. 5, 2002. First named inventor: Andre Gueziec. Entitled, "Personalized road traffic information dissemination."
- U.S. Appl. No. 60/365,104, filed Mar. 18, 2002. First named inventor: Christopher J. Hall. Entitled, "An Alternative Solution to the Problem of the Geolocating a Portable Radio Transmitter."
- U.S. Appl. No. 60/365,244, filed Mar. 18, 2002. First named inventor: Athanassios Diacakis. Entitled, "System and method for providing voice-activated presence information."
- U.S. Appl. No. 60/367,527, filed Mar. 22, 2002. First named inventor: William J. Sacco. Entitled, "Method and System of Mass Casualty Triage Prioritization."
- U.S. Appl. No. 60/367,708, filed Mar. 28, 2002. First named inventor: Gordon John Hines. Entitled, "Location Derived Presence Information."
- U.S. Appl. No. 60/367,967, filed Mar. 25, 2002. First named inventor: Jeffrey D. Mullen. Entitled, "Systems and methods for locating cellular phones."
- U.S. Appl. No. 60/370,862, filed Apr. 8, 2002. First named inventor: Douglas G. Dempster. Entitled, "Method for graphical interaction with geographic databases for broadcast presentation."
- U.S. Appl. No. 60/371,941, filed Apr. 10, 2002. First named inventor: Michael A. Sheha. Entitled, "Methods and System for Dynamic Estimation and Predictive Route Generation."
- U.S. Appl. No. 60/375,998, filed Apr. 24, 2002. First named inventor: Lau; et al. Entitled, "System, method and apparatus for acquiring, presenting, managing and using position information."
- U.S. Appl. No. 60/377,019, filed Apr. 30, 2002. First named inventor: Michael Pechatnikov. Entitled, "Real-time distribution of dynamic maps."
- Dunn; et al., "Wireless Emergency Call System", IBM TDB, Sep. 1994.
- Ebine, "Dual Frequency resonant base station antennas for PDC systems in Japan", IEEE, pp. 564-567, 1999.
- Evans, "In-Vehicle Man-Machine Interaction the Socrates Approach", Vehicle Navigation & Information System Conference Proceedings, Aug. 31-Sep. 2, 1994, pp. 473-477.
- Helal; et al., "Drishti: An Integrated Navigation System for Visually Impaired and Disabled", Fifth International Symposium on Wearable Computers (ISWC'01), IEEE, 2001, pp. 149-156.
- Hohman; et al., "GPS Roadside Integrated Precision Positioning System", Position Location and Navigation Symposium (IEEE 2000), pp. 221-230.
- Jain, R., "Potential Networking Applications of Global Positioning Systems (GPS)", [online] [retrieved on Nov. 18, 2008] [retrieved from <http://arxiv.org/ftp/cs/papers/9809/9809079.pdf>] OSU Technical Report TR-24, Apr. 1996, pp. 1-40.
- Jirawimut; et al., "A Method for Dead Reckoning Parameter Correction in Pedestrian Navigation System", IEEE Transactions on Instrumentation and Measurement, vol. 52, No. 1, Feb. 2003, pp. 209-215.
- Lloyd; et al., "Cellular phone base stations installation violate the Electromagnetic Compatibility regulations", IEEE, 2004.
- Miller; et al., "Synchronization of Mobile XML Databases by Utilizing Deferred Views", IEEE 2004.
- Nardi; et al., "Integrating Communication and Information through Contact Map", Communications of the ACM, vol. 45, No. 4, Apr. 2002.
- Northard, "Docking Station Communication Link", IBM TDB, Feb. 1994.
- Oh; et al., "Spatial Applications Using 4S Technology for Mobile Environment", IEEE 2002.
- Paksoy; et al., "The Global Position System—Navigation Tool of the Future", Journal of Electrical & Electronics, 2002, vol. 2, No. 1, pp. 467-476.
- Parikh, "Tele Locate", IBM Technical Disclosure Bulletin, [online] [Retrieved Nov. 7, 2008] Retrieved from the Internet, URL: <https://www.delphion.com/tldb?order=92A+62775>; Sep. 1992; 1 page.
- RD 409052, Research Disclosure Alerting Abstract, "Location dependent information for satellite based vehicle communication-required application of Global Position System (GPS) to automatically extract relevant portions of data package as vehicle changes position," May 10, 1998, 1 page.
- Rogers; et al., "Adaptive User Interfaces for Automotive Environments", IEEE Intelligent Vehicles Symposium 2000, Oct. 3-5, 2000, pp. 662-667.
- Samadani; et al., "PathMaker: Systems for Capturing Trips", IEEE (2004) International Conference on Multimedia and Expo., Publication Date: Jun. 27-30, 2004, vol. 3, pp. 2123-2126, 2004.
- Spohrer. "New Paradigms for Using Computers", 1997; retrieved from the Internet, URL: <http://almaden.ibm.com/npsc97/1997/spohrer.htm>.
- Yang; et al. "Global Snapshots for Distributed Debugging", IEEE, pp. 436-440, 1992.
- Yanyan; et al., "The model of optimum route selection in vehicle automatic navigation system based on unblocked reliability analyses", IEEE 2003.
- Civilis; et al., "Efficient Tracking of Moving Objects with Precision Guarantees", IEEE, Proceedings of the First Annual International Conference on Mobile and Ubiquitous Systems: Networking and Services, 2004, 10 pages.
- Budka; et al., "A Bayesian method to Improve Mobile Geolocation Accuracy", IEEE, 2002, pp. 1021-1025.
- Yamamoto; et al., "Position Location Technologies Using Signal Strength in Cellular Systems", IEEE, 2001, pp. 2570-2575.
- Drane; et al., "The accurate location of mobile telephones", Third Annual World Congress on Intelligent Transport Systems, Orlando, Florida, Oct. 1996.
- Wang; et al., "A Unified Vehicle Supervising and Traffic Information System", IEEE, 1996, pp. 968-972.
- US 6,731,928, May 4, 2004, Tanaka (withdrawn).
- Challe, "CARMINAT—An Integrated information and guidance system," Vehicle Navigation and Information Systems Conference, Oct. 20-23, 1991, Renault—Direction de la Recherche, Rueil-Malmaison, France.
- Pungel, "Traffic control—beat the jam electronically," Funkschau, 1988, 18:43-45.
- Rillings and Betsold, "Advanced driver information systems," Vehicular Technology, IEEE Vehicular Technology Society, 1991, 40:31-40.
- Tsuzawa and Okamoto, "Advanced Mobile Traffic Information and Communication System," First Vehicle Navigation and Information Systems Conference, Sep. 11-13, 1989, Toronto, Canada, Abstract only.
- Wong, "GPS: making roads safer and solving traffic tangles," Asia Engineer, 1995, 23(9):31-32.
- Ayatsuka; et al., "UbiquitousLinks: Hypermedia Links Embedded in the Real World, Technical Report of Information Processing Society, 96-HI-67," Information Processing Society of Japan, Jul. 11, 1996, 96(62):23-30.
- Nagao; et al., Walk Navi: A Location-Aware Interactive Navigation/Guideline System and Software III, First edition, pp. 9-48, published by Kindai-Kagaku-Sya Co. Ltd., Dec. 10, 1995.
- Freundschuh, "Does 'Anybody' Really Want (or Need) Vehicle Navigation Aids?" First Vehicle Navigation and Information System Conference, Sep. 11-13, 1989, Toronto, Canada, 5 pages.
- Gould, "The Provision of Usable Navigation Assistance: Considering Individual Cognitive Ability," First Vehicle Navigation and Information System Conference, Sep. 11-13, 1989, Toronto, Canada, 7 pages.
- Mark, "A Conceptual Model for Vehicle Navigation Systems," First Vehicle Navigation and Information System Conference, Sep. 11-13, 1989, Toronto, Canada, 11 pages.
- Burnett, "Usable Vehicle Navigation Systems: Are We There Yet?" Vehicle Electronic Systems 2000, Jun. 29-30, 2000, 3.1.1-3.1.12.

(56)

## References Cited

## OTHER PUBLICATIONS

- "New Handsets Strut Their Stuff At Wireless '99," Internet: URL: <http://findarticles.com/p/articles/mi.sub.--mOBMD/is.sub.--1999.sub.--Feb-.sub.--11/ai.sub.--n27547656/> downloaded from Internet on Feb. 11, 1999, 3 pages.
- Green; et al., "Suggested Human Factors Design Guidelines for Driver Information Systems," Technical Report UMTRI-93-21, Nov. 1993, 119 pages.
- Tijerina; et al., "Driver Workload Assessment of Route Guidance System Destination Entry While Driving: A Test Track Study," Proceedings of the 5th ITS World Congress, Oct. 12-16, 1998, Seoul, Korea, 9 pages.
- Muraskin, "Two-Minute Warnings for School Bus Riders," [retrieved on Feb. 27, 2013] Internet: URL: <http://www.embedded.com/electronics-news/4129835/TWO-MINUTE-WARNINGS-FOR-SCHOOL-BUS-RIDERS#> Jul. 1, 1999, 2 pages.
- Kreller; et al., "A Mobile-Aware City Guide Application," ACTS Mobile Communication Summit, 1998, Rhodes, Greece, 7 pages.
- Pascoe; et al., "Developing Personal Technology for the Field," Personal Technologies, 1998, 2:28-36.
- Tebbutt, "Dial your way out of the woods," The Australian, Feb. 2000, 1 page.
- Tso; et al., "Always on, Always Connected Mobile Computing," Mobile Communications Operation—Mobile Handheld Products Group, 1996, pp. 918-924.
- Abowd; et al., "Context-awareness in wearable and ubiquitous computing," 1st International Symposium on Wearable Computers, Oct. 13-14, 1997, Cambridge, MA, 9 pages.
- Cheverst; et al., "The Support of Mobile-Awareness in Collaborative Groupware," Personal Technologies, 1999, 3:33-42.
- Cheverst; et al., "Exploiting Context to Support Social Awareness and Social Navigation," SIGGROUP Bulletin Dec. 2000, 21(3):43-48.
- Cheverst; et al., "Services to Support Consistency in Mobile Collaborative Applications," Proc. 3rd International Workshop on Services in Distributed Networked Environments, 1996, 8 pages.
- Costa; et al., "Experiments with Reflective Middleware," Proceedings of the ECOOP'98 Workshop on Reflective Object-Oriented Programming and Systems, ECOOP'98 Workshop Reader, 1998, 13 pages.
- "Report on Location Service feature (LCS) 25.923 v1.0.0," TSG-RAN Working Group 2 (Radio layer 2 and Radio layer 3), Berlin, May 25-28, 1999, 45 pages.
- Wang et al., "Location Aware Information Agent over WAP," Tamkang Journal of Science and Engineering, 2000, 3(2):107-115.
- Tarumi et al., "Public Applications of SpaceTag and Their Impacts," Digital Cities, LNCS 1765, 2000, 14 pages.
- O'Grady et al., "A Tourist-Centric Mechanism for Interacting with the Environment," Proceedings of the First International Workshop on Managing Interactions in Smart Environments (MANSE '99), Dublin, Ireland, Dec. 1999, 12 pages.
- McCarthy et al., "ACTIVEMAP: A Visualization Tool for Location Awareness to Support Informal Interactions," HUC '99, LNCS 1707, 1999, 13 pages.
- Hodes et al., "Composable Ad hoc Location-based Services for Heterogeneous Mobile Clients," University of California, Berkeley, May 5, 1998, 16 pages.
- Dey et al., "CyberDesk: a framework for providing self-integrating context-aware services," ACM, Inc, 1998, 8 pages.
- Brown, "Triggering Information by Context," [online] Retrieved from the Internet on May 25, 2012: URL: <http://kar.kent.ac.uk/21602/2/pdf.pdf>, The University of Kent at Canterbury, 1998, 10 pages.
- Brown, "The stick-e document: a framework for creating context-aware applications," Electronic Publishing, 1995, 8:259-272.
- Clarke et al., "Development of Human Factors Guidelines for Advanced Traveler Information Systems (ATIS) and Commercial Vehicle Operations (CVO): Comparable Systems Analysis," U.S. Department of Transportation Federal Highway Administration, Publication No. FHWA-RD-95-197, Dec. 1996, 212 pages.
- "LaBarge in joint venture on bus system," [online] Retrieved from the Internet on May 25, 2012: URL: <http://www.bizjournals.com/stlouis/stories/1998/08/10/focus2.html>, Aug. 9, 1998, 1 page.
- Shekhar et al., "Genesis and Advanced Traveler Information Systems (ATIS): Killer Applications for Mobile Computing?" NSF Mobidata Workshop on Mobile and Wireless Information Systems, Nov. 1994, 20 pages.
- Serafin et al., "Functions and Features of Future Driver Information Systems," Technical Report UMTRI-91-16, May 1991, 104 pages.
- Ni et al., "On-Board Advanced Traveler Information Systems," Earlier Faculty Research, University of California Transportation Center, UC Berkeley, Dec. 1, 2002, 11 pages.
- "School Buses to Carry Noticom's First Application," [online] Retrieved from the Internet on May 25, 2012: URL: [http://findarticles.com/p/articles/mi\\_mOBMD/is\\_1999\\_Feb\\_17/ai\\_n27547754/?tag=content;coll](http://findarticles.com/p/articles/mi_mOBMD/is_1999_Feb_17/ai_n27547754/?tag=content;coll), Communications Today, Feb. 17, 1999, 2 pages.
- Mahmassani et al., "Providing Advanced and Real-Time Travel/Traffic Information to Tourists," Center for Transportation Research, Bureau of Engineering Research, The University of Texas at Austin, Oct. 1998, 15 pages.
- Yim et al., "Travinfo Field Operational Test: Work Plan for the Target, Network, and Value Added Reseller (VAR) Customer Studies," Working Papers, California Partners for Advanced Transit and Highways (PATH), Institute of Transportation Studies, UC Berkeley, Apr. 1, 1997, 48 pages.
- Khattak et al., "Bay Area ATIS Testbed Plan," Research Reports, California Partners for Advanced Transit and Highways (PATH), Institute of Transportation Studies, UC Berkeley, Aug. 1992, 83 pages.
- Burnett, "Usable Vehicle Navigation Systems: Are We There Yet?," Vehicle Electronic Systems 2000, Jun. 29-30, 2000, pp. 3.1.1-3.1.12.
- Noonan et al., "Advanced Traveler Information Systems," Intelligent Transportation Systems Field Operational Test Cross-Cutting Study, Sep. 1998, 27 pages.
- Bonsignore, "A Comparative Evaluation of the Benefits of Advanced Traveler Information System (ATIS) Operational Tests," MIT Masters Thesis, Feb. 1994, 140 pages.
- Hoogenraad, "Location Dependent Services," 3rd AGILE Conference on Geographic Information Science, Helsinki/Espoo, Finland, May 25-27, 2000, pp. 74-77.
- Miller et al., "Integrating Hierarchical Navigation and Querying: A User Customizable Solution," ACM Multimedia Workshop on Effective Abstractions in Multimedia Layout, Presentation, and Interaction, San Francisco, CA, Nov. 1995, 8 pages.
- Wheeler et al., "Development of Human Factors Guidelines for Advanced Traveler Information Systems and Commercial Vehicle Operations: Task Analysis of ATIS/CVO Functions," US Dept. Transportation Federal Highway Administration Research and Development, Publication No. FHWA-RD-95-176, Nov. 1996, 124 pages.
- Benefon ESCI GSM+GPS Personal Navigation Phone, benefon.com, Copyright 2001, 4 pages.
- Dey, "Context-Aware Computing: The CyberDesk Project," [online] Retrieved from the Internet on May 25, 2012: URL: <http://www.cc.gatech.edu/fce/cyberdesk/pubs/AAAI98/AAAI98.html>; AAAI '98 Spring Symposium, Stanford University, Mar. 23-25, 1998, 8 pages.
- Ygnace et al., "Travel Time Estimation on the San Francisco Bay Area Network Using Cellular Phones as Probes", Working Paper, Institute of Transportation Studies, University of California, Berkeley, 2000, 56 pages.
- Civilis et al., "Efficient Tracking of Moving Objects with Precision Guarantees", A DB Technical Report TR-5, Feb. 21, 2004, 23 pages.
- Clarke et al., "An Architecture for Dynamically Extensible Operating Systems," Distributed Multimedia Research Group, Department of Computing, Lancaster University, 1998, 20 pages.
- Veltman, "Frontiers in Electronic Media", Interactions Journal of the ACM, New York, Jul.-Aug. 1997, pp. 32-64.
- Goran M. Djuknie, Robert E. Richton, "Geolocation and Assisted GPS," Computer, vol. 34, No. 2, pp. 123-125, Feb. 2001.
- Rozier et al., "Hear & There: An Augmented Reality System of Linked Audio", Proceedings of the International Conference on Auditory Display, Atlanta, GA, Apr. 2000, 6 pages.

(56)

**References Cited**

## OTHER PUBLICATIONS

Rekimoto et al., "Augment-able Reality: Situated Communication through Physical and Digital Spaces", iswc, Second International Symposium on Wearable computers (ISWC'98), 1998, 8 pages.

Nardi et al., "Integrating Communication and Information through Contact Map", Communications of the ACM, vol. 45, No. 4, Apr. 2002, 9 pages.

Meier et al., "Location-Aware Event-Base Middleware: A Paradigm for Collaborative Mobile Applications?", Department of Computer Science, Trinity College Dublin, Ireland, Sep. 2003, 5 pages.

"Map Reading and Land Navigation Field Manual No. 3-25.26", Headquarters Department of the Army, Washington, DC, [online] Retrieved from the Internet on May 25, 2012: URL: <http://155.217.58.58/cgi-bin/atdl.dll/fm/3-25.26/toc.htm>, Jul. 20, 2001, pp. 1-7 and J-1 to J-3.

Dibdin, "Where are mobile location based services?", CM316 Multimedia Systems Paper, Dec. 14, 2001, 8 pages.

Charny, "AT&T puts 411 to the text", [online] Retrieved from the Internet on May 25, 2012: URL: [http://news.cnet.com/2100-1039\\_3-1000669.html](http://news.cnet.com/2100-1039_3-1000669.html); May 8, 2003; 5 pages.

Bederson, "Audio Augmented Reality: A Prototype Automated Tour Guide", [online] Retrieved from the Internet on May 25, 2012: URL: <http://www.cs.umd.edu/bederson/papers/chi-95-aar/>, ACM Human Computer in Computing Systems conference (CHI'95) 1995, 4 pages.

Feddema; et al., "Cooperative Sentry Vehicles and Differential GPS Leapfrog," 2000, United States Department of Energy, pp. 1-12.

Maxwell; et al., "Alfred: The Robot Waiter Who Remembers You," AAAI Technical Report WS-99-15, 1999, 12 pages.

Shibata; et al., "Development and Integration of Generic Components for a Teachable Vision-Based Mobile Robot," IEEE/ASME Transactions on Mechatronics, 1996, 1(3):230-236.

"27 Countries in your pocket"; [online] [Retrieved on Sep. 29, 2005] Retrieved from the Internet URL: <http://www.mio-tech.be/en/printview/press-releases-2005-09-29.htm>; 1 page.

"Mio 269+ Users Manula"; 2005; 44 pages.

Balliet, "Transportation Information Distribution System", IBM Technical Disclosure Bulletin, [online] [Retrieved Nov. 7, 2008] Retrieved from the Internet, URL: <https://www.delphion.com/tdbs/tdb?order=86A+61395>; Jun. 1986; 2 pages.

Beard; et al., "Estimating Positions and Paths of Moving Objects", IEEE 2000, pp. 1-8.

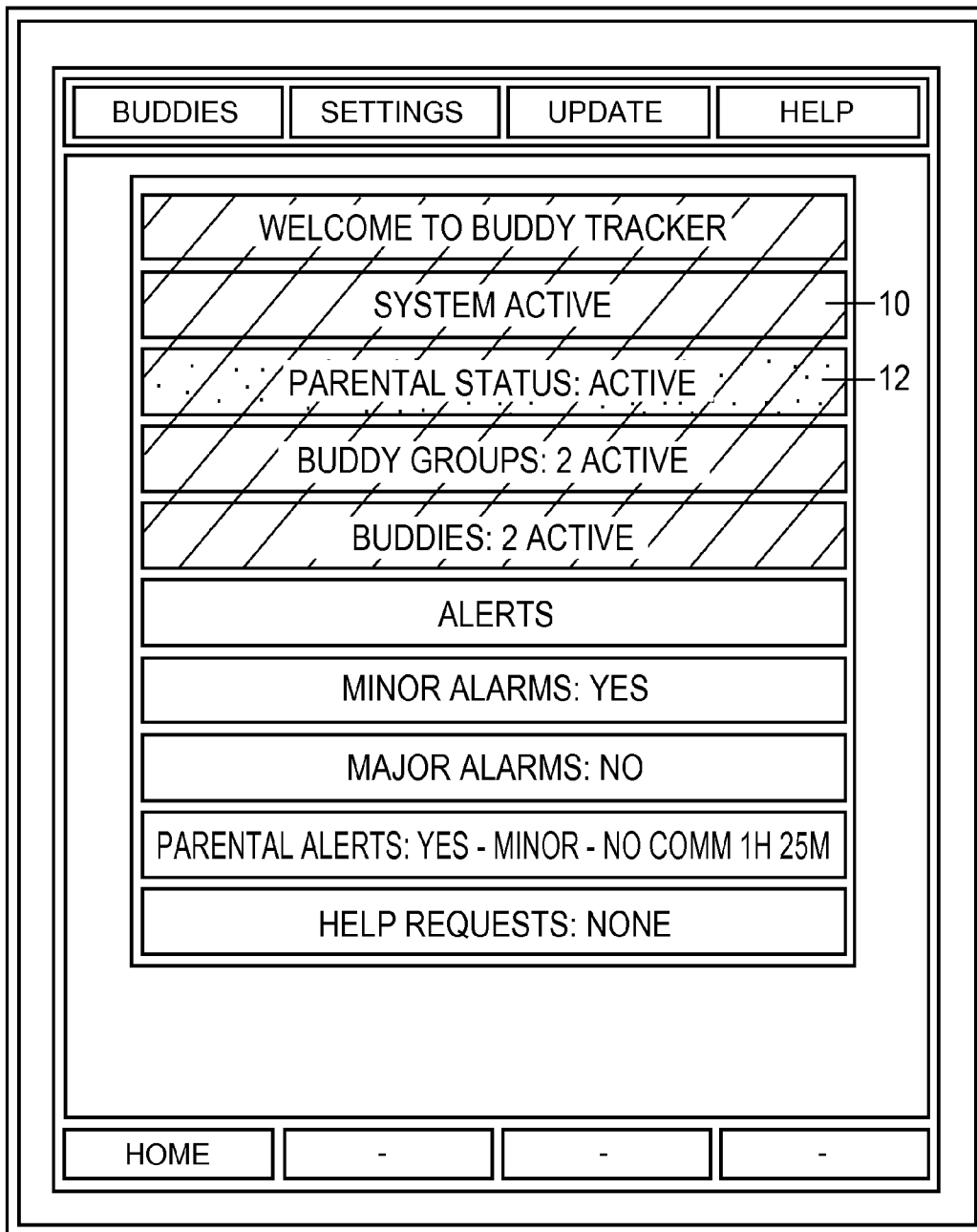
Berman; et al., "The Role of Dead Reckoning and Inertial Sensors in Future General Aviation Navigation", IEEE, 1998, pp. 510-517.

Boonsrimuang; et al., "Mobile Internet Navigation System", IEEE, 2002, pp. 325-328.

Camp; et al., "A computer-based method for predicting transit time systems", Decision Sciences, vol. 5, pp. 339-346, 1974.

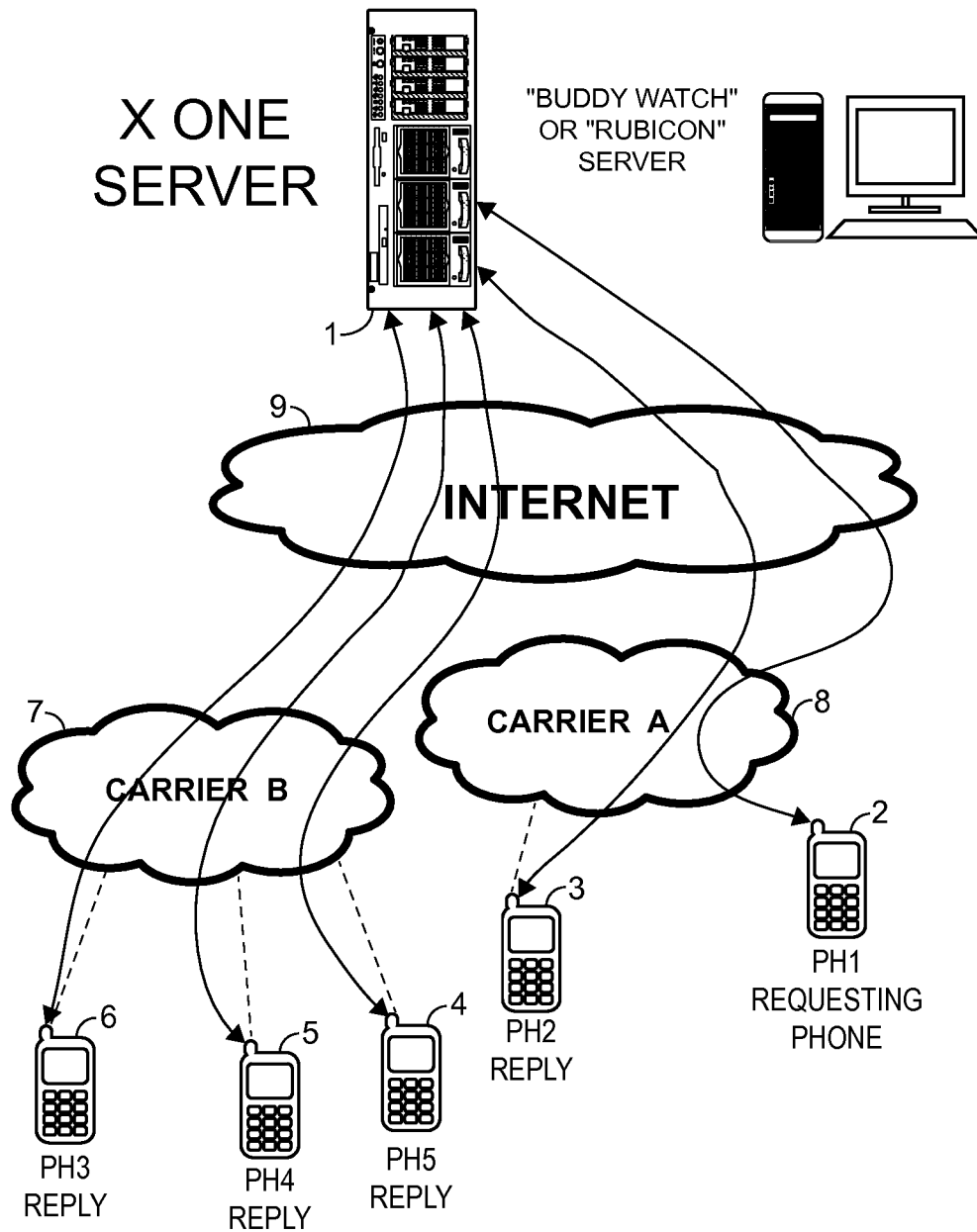
Christie; et al., "Development and Deployment of GPS wireless devices for E911 and Location based services", IEEE 2002.

\* cited by examiner

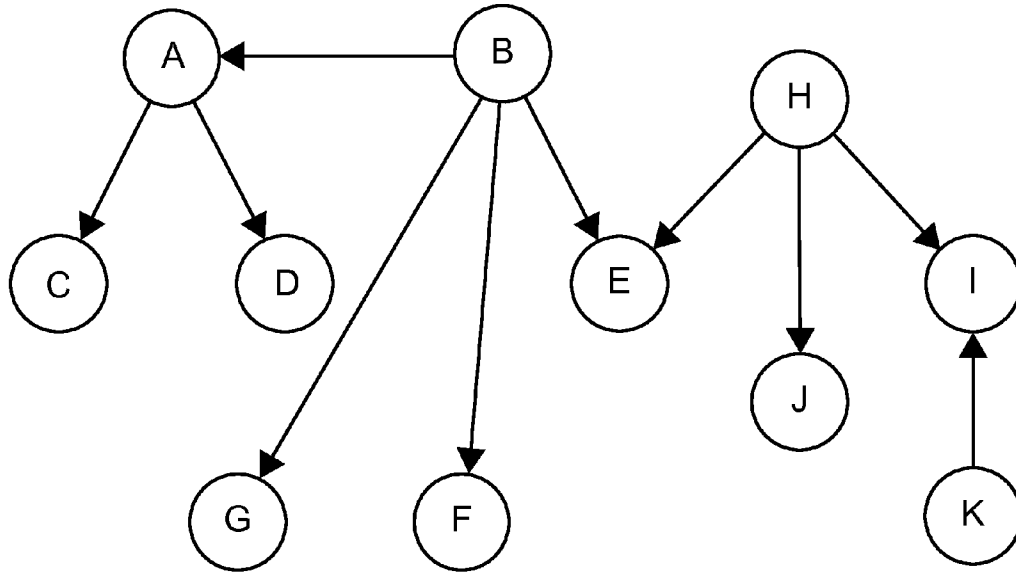


OPENING SCREEN

**FIG. 1**

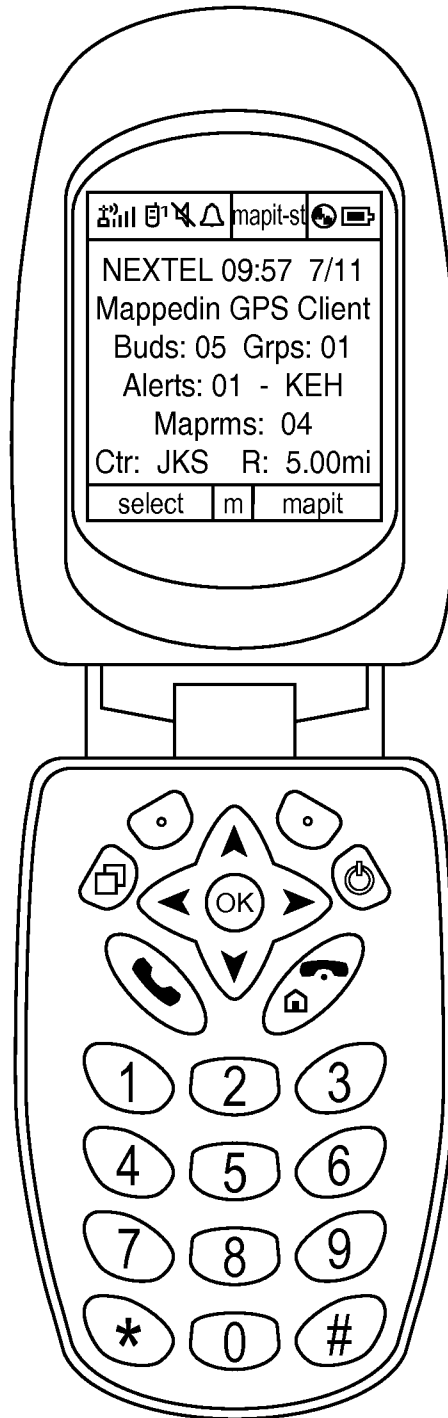


**FIG. 2A**



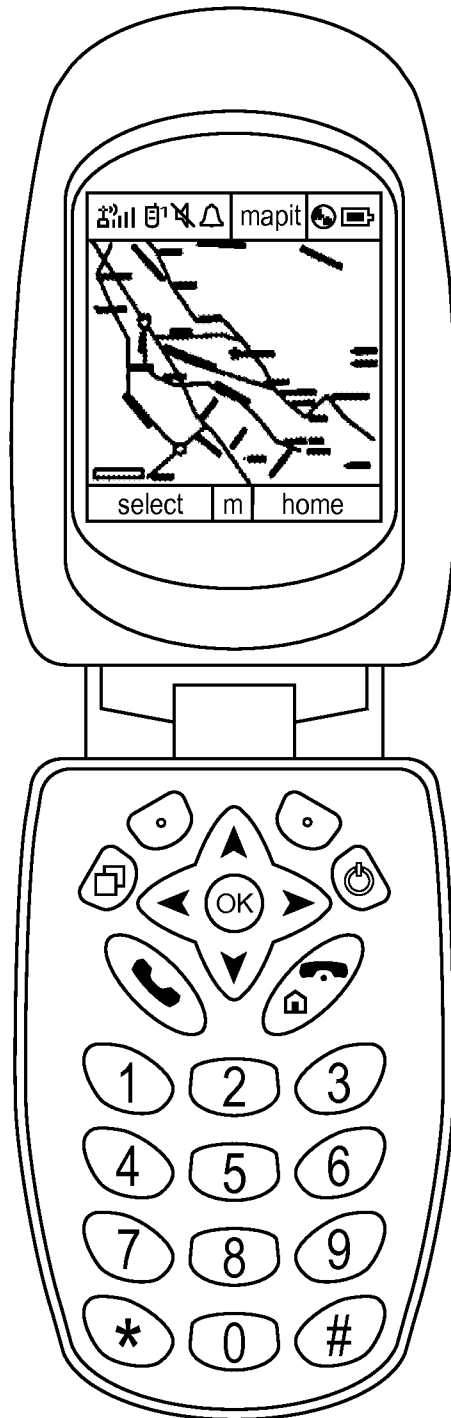
MATRIX OF BUDDY LIST

**FIG. 2B**

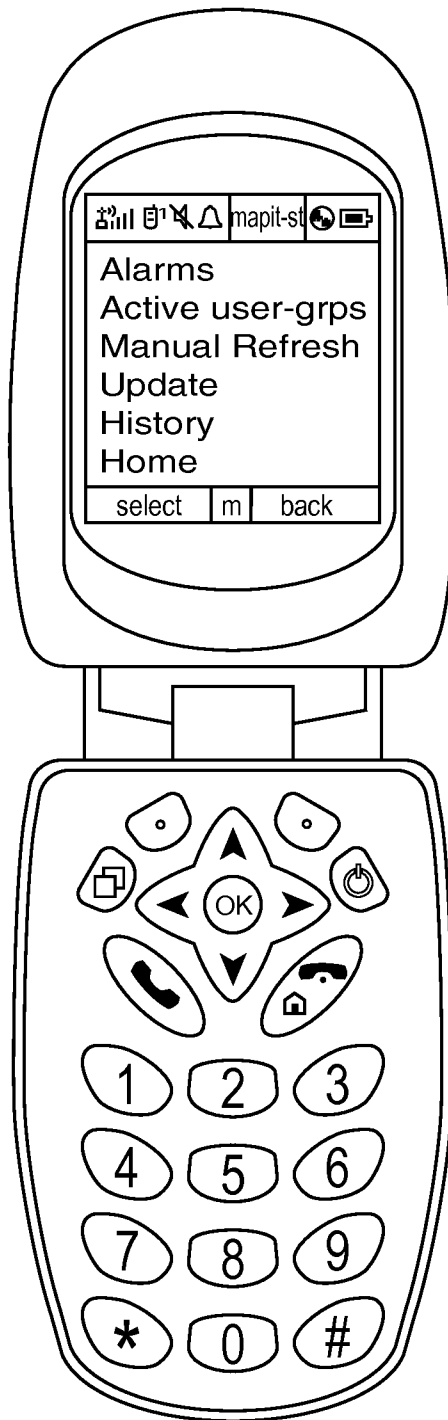


**FIG. 2C**

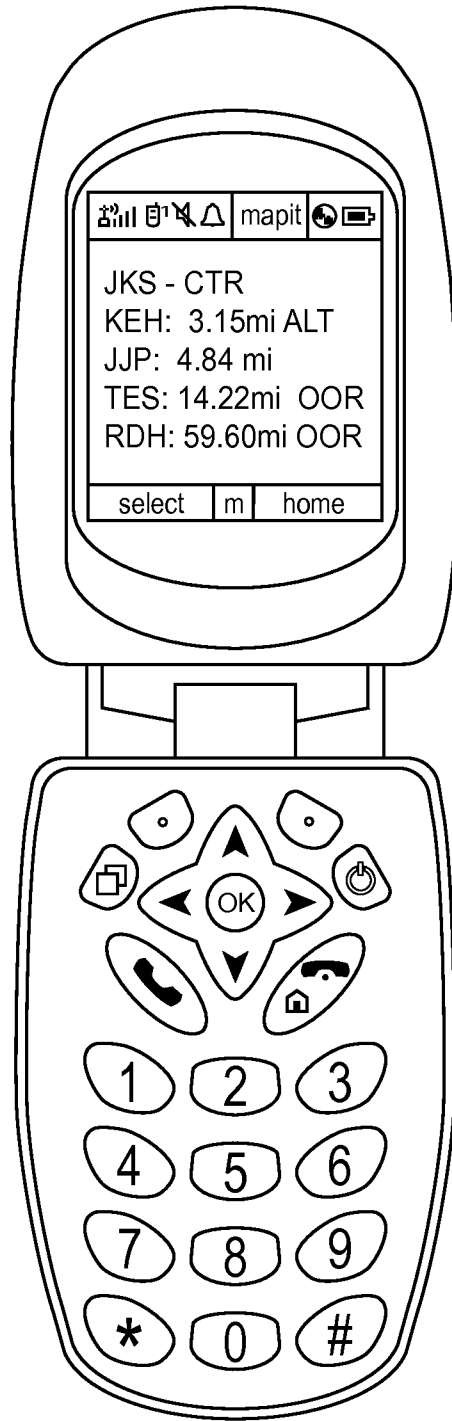




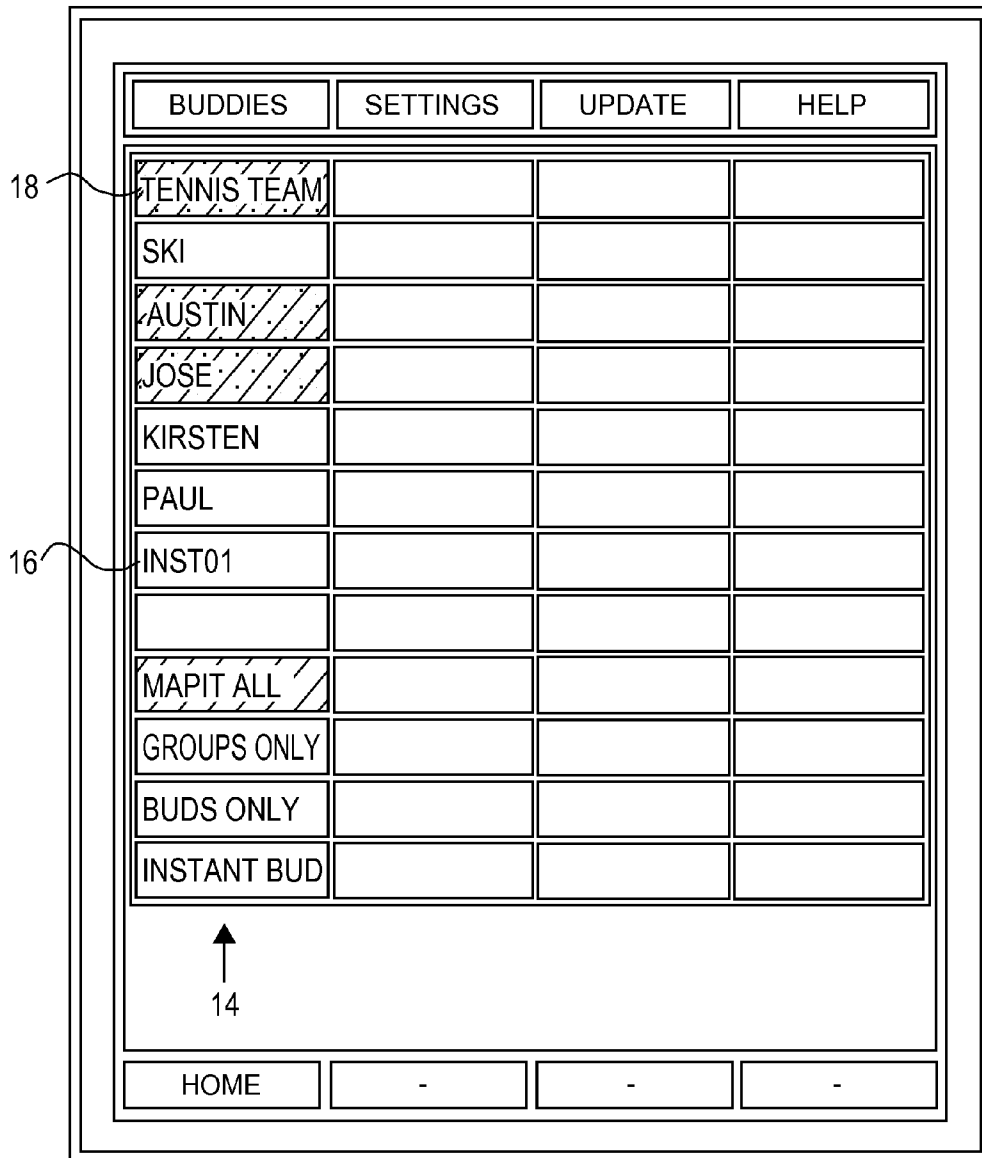
**FIG. 2D**



**FIG. 2E**

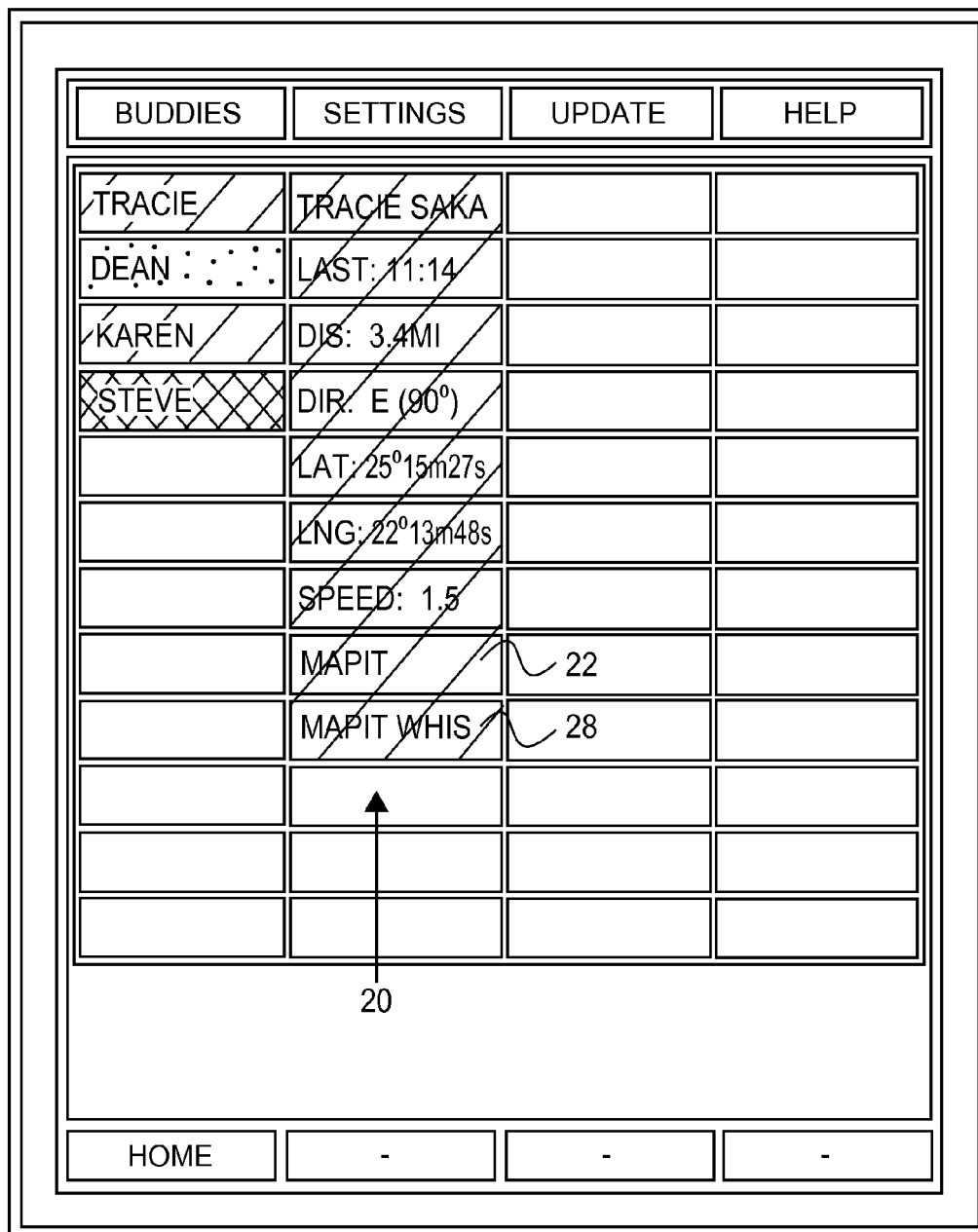


**FIG. 2F**



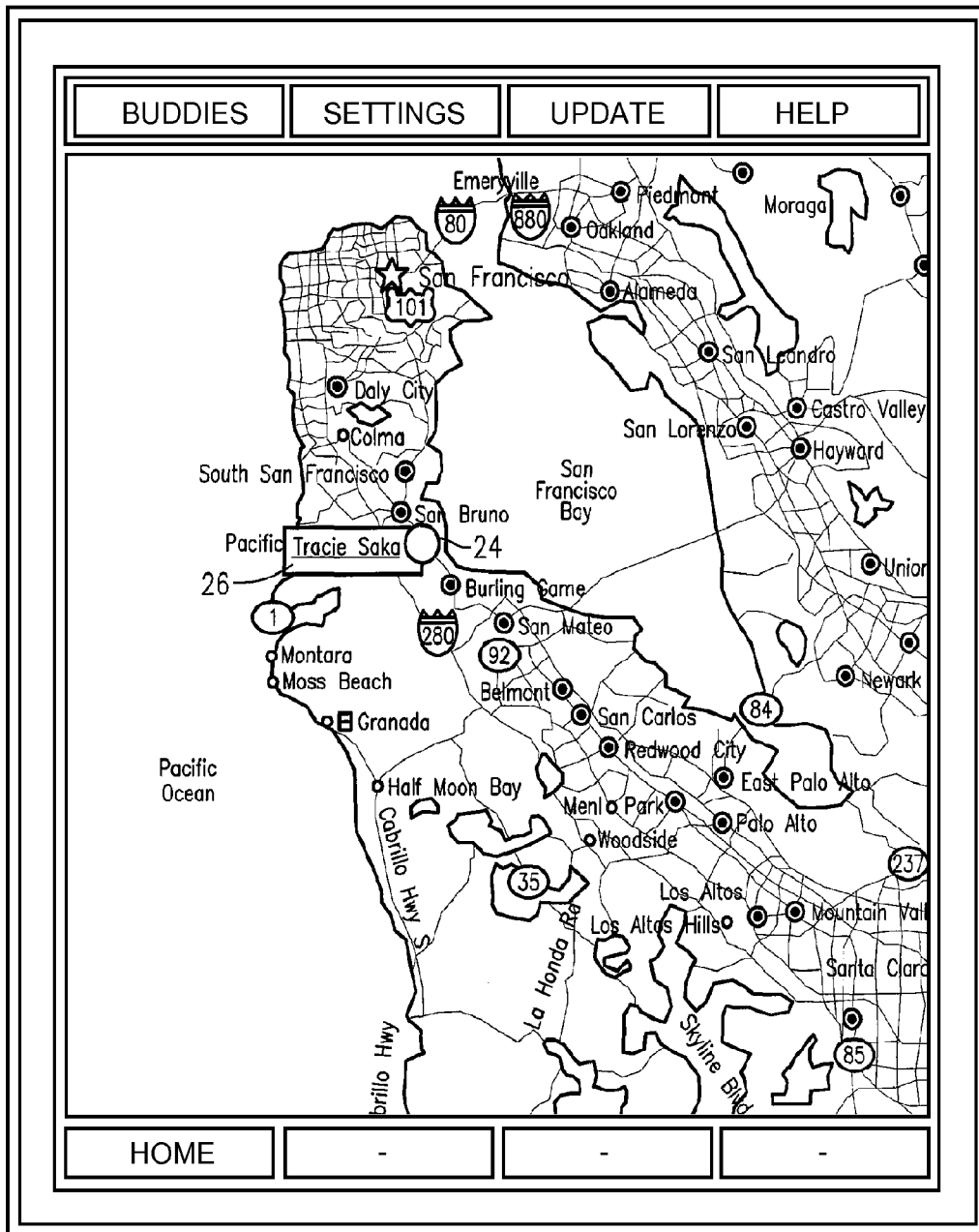
TYPICAL SCREEN SHOWING A NAMED BUDDY LIST'S CONTENTS

**FIG. 3**



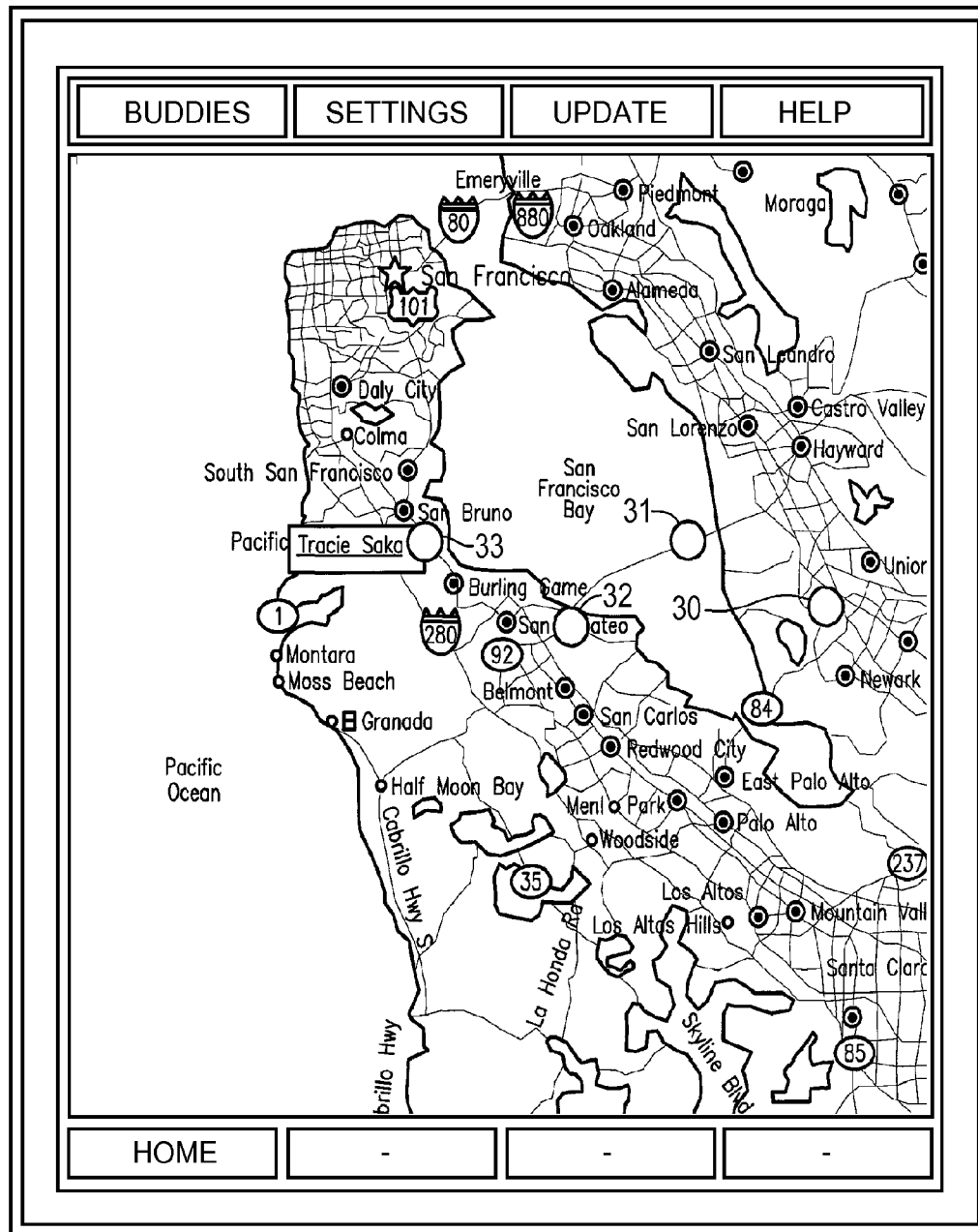
TYPICAL SCREEN SHOWING A BUDDY'S LOCATION ETC.

**FIG. 4**



MAPIT™ DISPLAY

**FIG. 5**



MAPIT DISPLAY SHOWING POSITION HISTORY OF A BUDDY

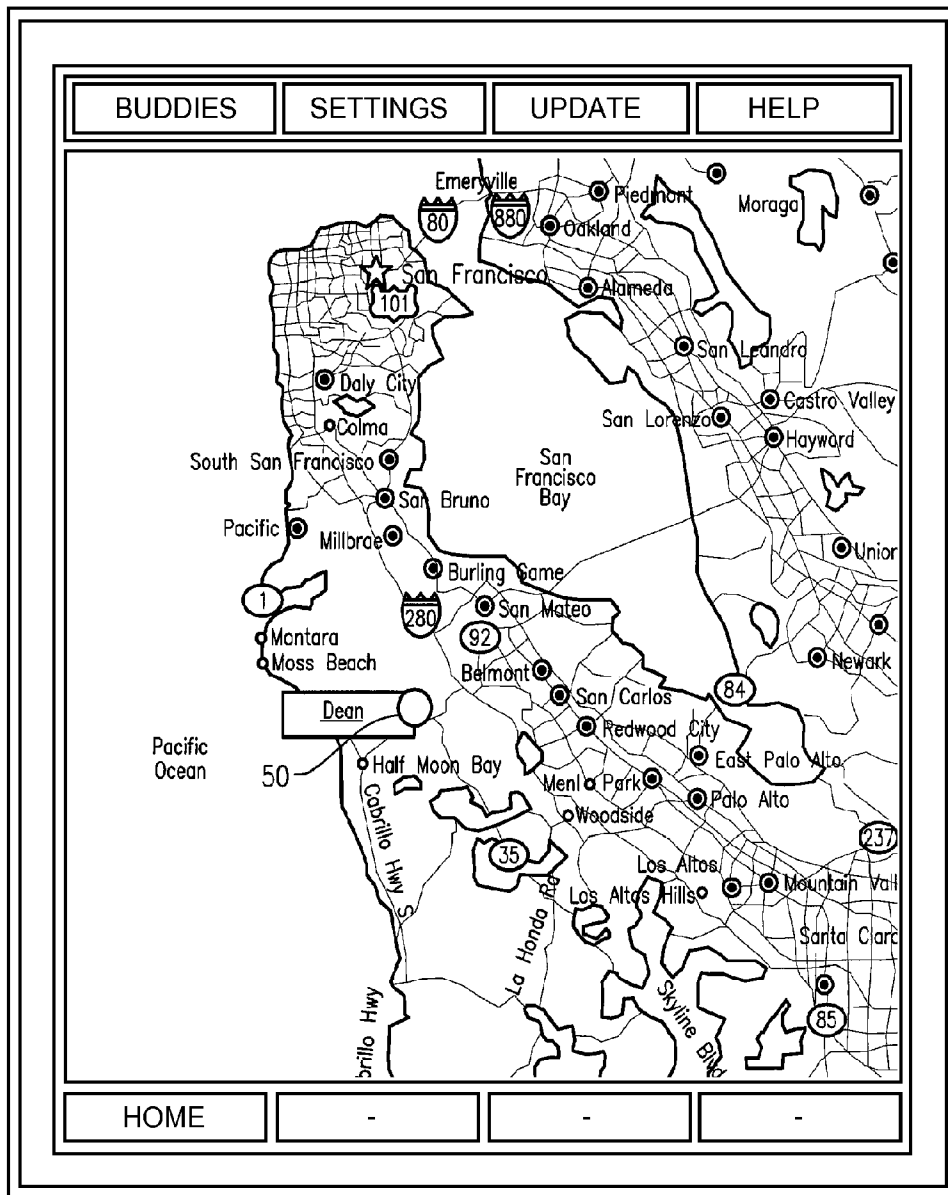
**FIG. 6**

BUDDIES	SETTINGS	UPDATE	HELP
TRACIE			
<del>DEAN</del>	<del>DEAN SMITH</del> — 36		
KAREN	<del>LAST: 11:14</del> — 34		
STEVE	<del>DIS: 3.4MI</del> — 38		
	<del>DIR: E (90°)</del> — 40		
	<del>LAT: 25°15m27s</del> — 42		
	<del>LNG: 22°13m48s</del> — 44		
	<del>SPEED: 1.5</del> — 46		
	MAPIT — 48		
	MAPIT W HIS		
HOME	-	-	-

TYPICAL SCREEN SHOWING POSITION AND STATUS OF A MEMBER OF A GROUP

**FIG. 7**





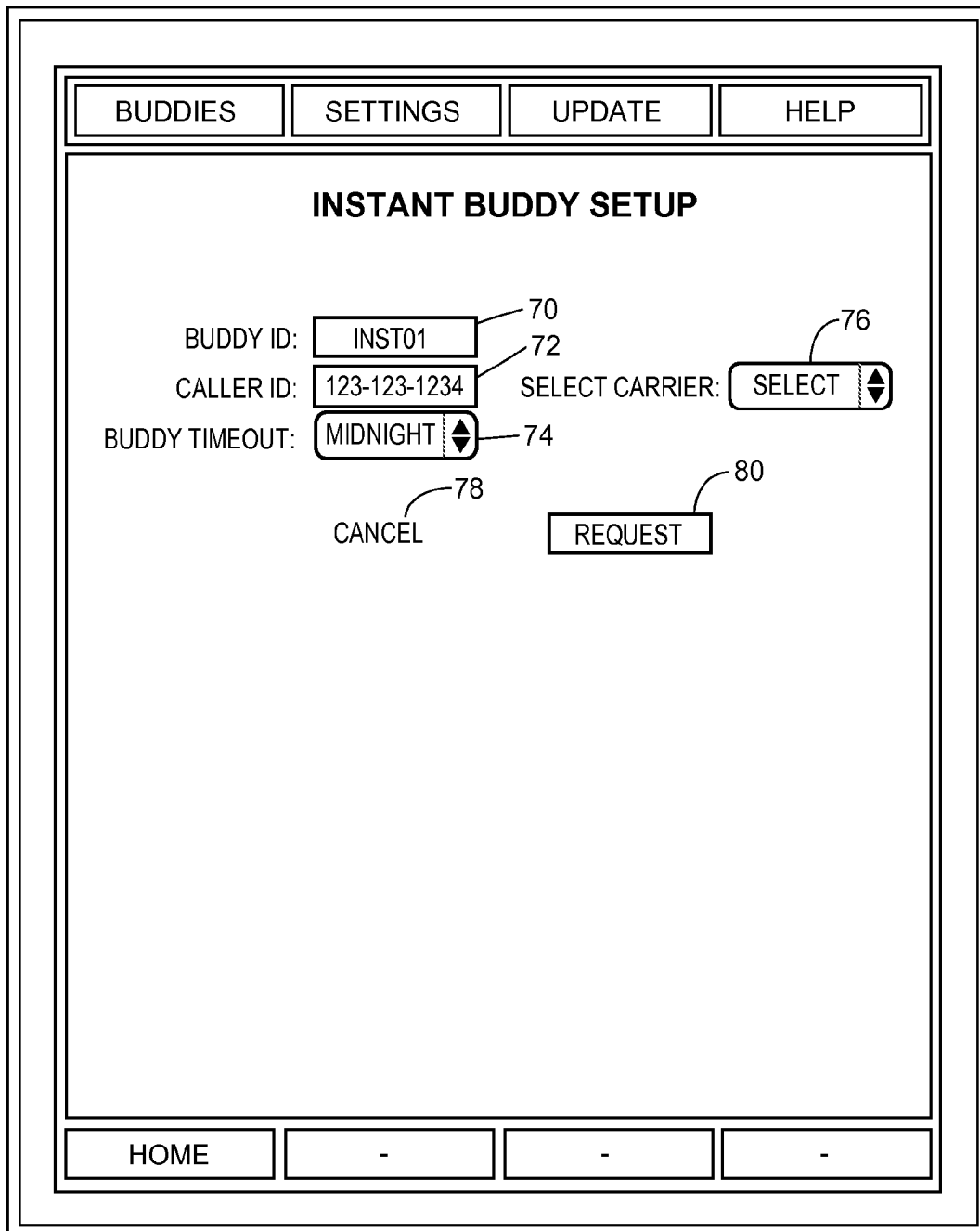
MAPIT DISPLAY WHEN THE POSITION OF A BUDDY IS REQUESTED

**FIG. 8**

BUDDIES	SETTINGS	UPDATE	HELP
TENNIS TEAM			
SKI			
AUSTIN			
JOSE			
KIRSTEN			
PAUL			
12313134Kdx1	INST01	52	
	LAST: 10:47	54	
	DIS: 4.7MI	56	
	DIR: NE (45°)	58	
	LAT: 25°15m27s	60	
	LNG: 22°13m48s	62	
	SPEED: NONE	64	
	MAPIT	66	
	MAPIT W HIS	68	
HOME	-	-	-

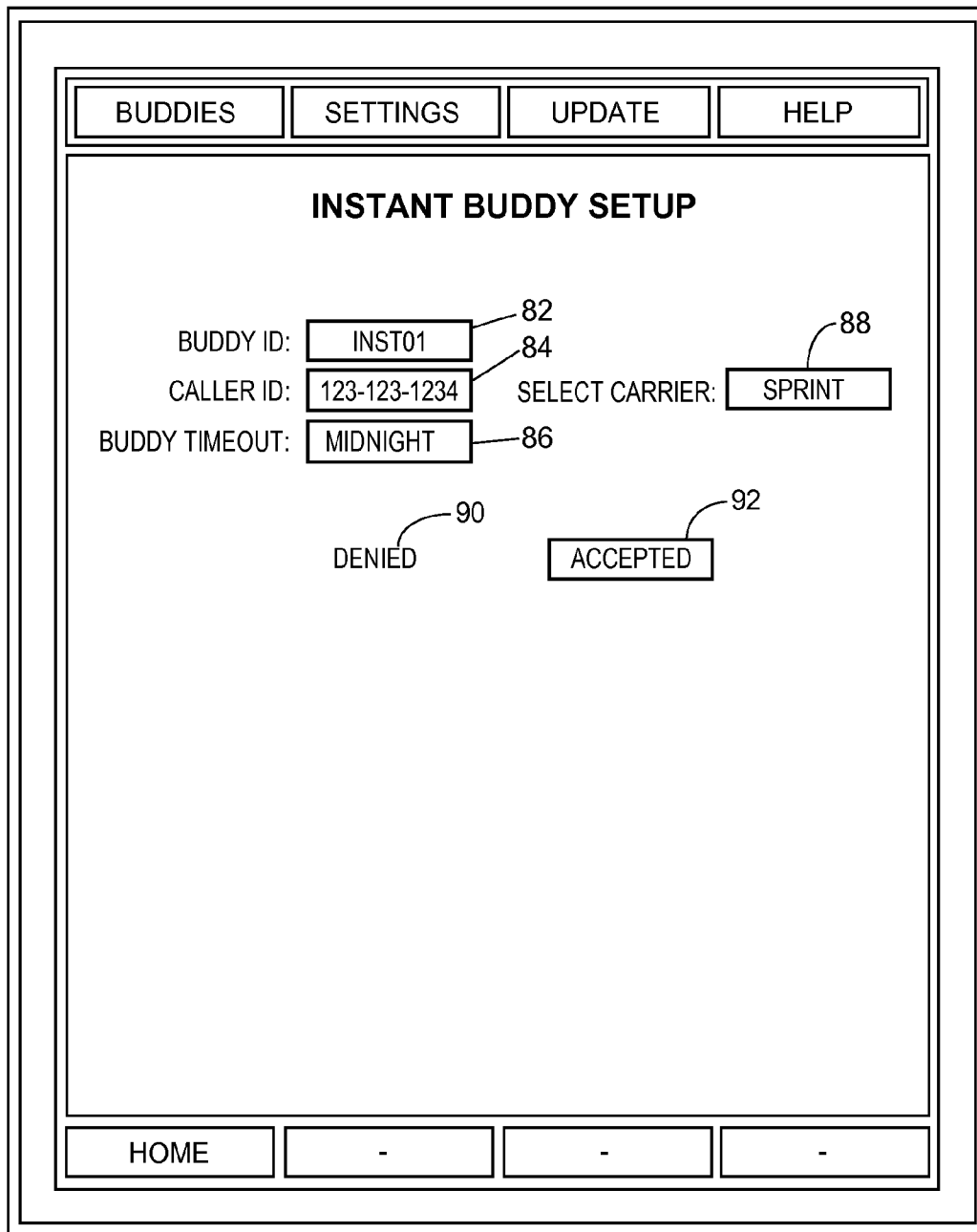
SCREEN SHOT SHOWING AN INSTANT BUDDIES LOCATION

**FIG. 9**



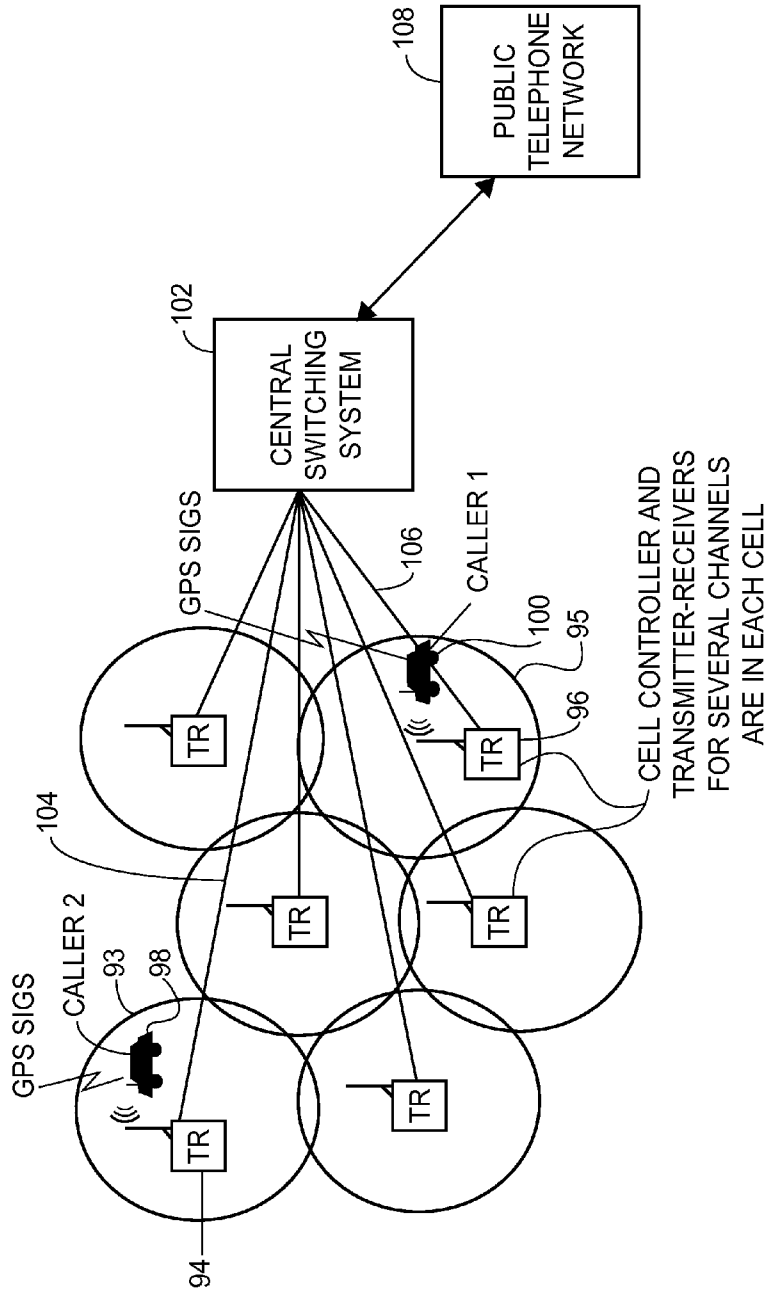
INSTANT BUDDY SETUP SCREEN

**FIG. 10**



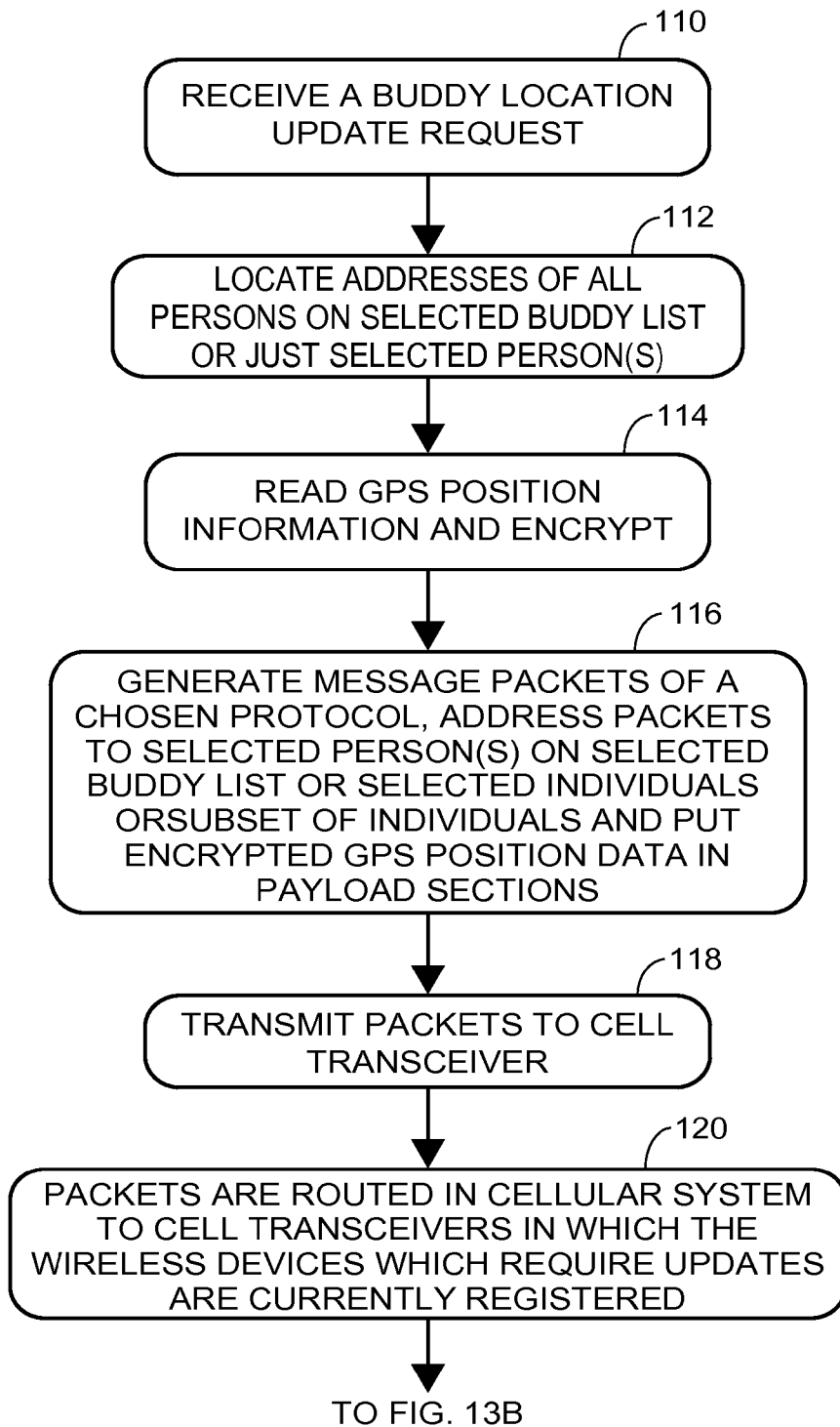
INSTANT BUDDY SETUP SCREEN DISPLAYED ON PHONE OF INSTANT BUDDY

**FIG. 11**



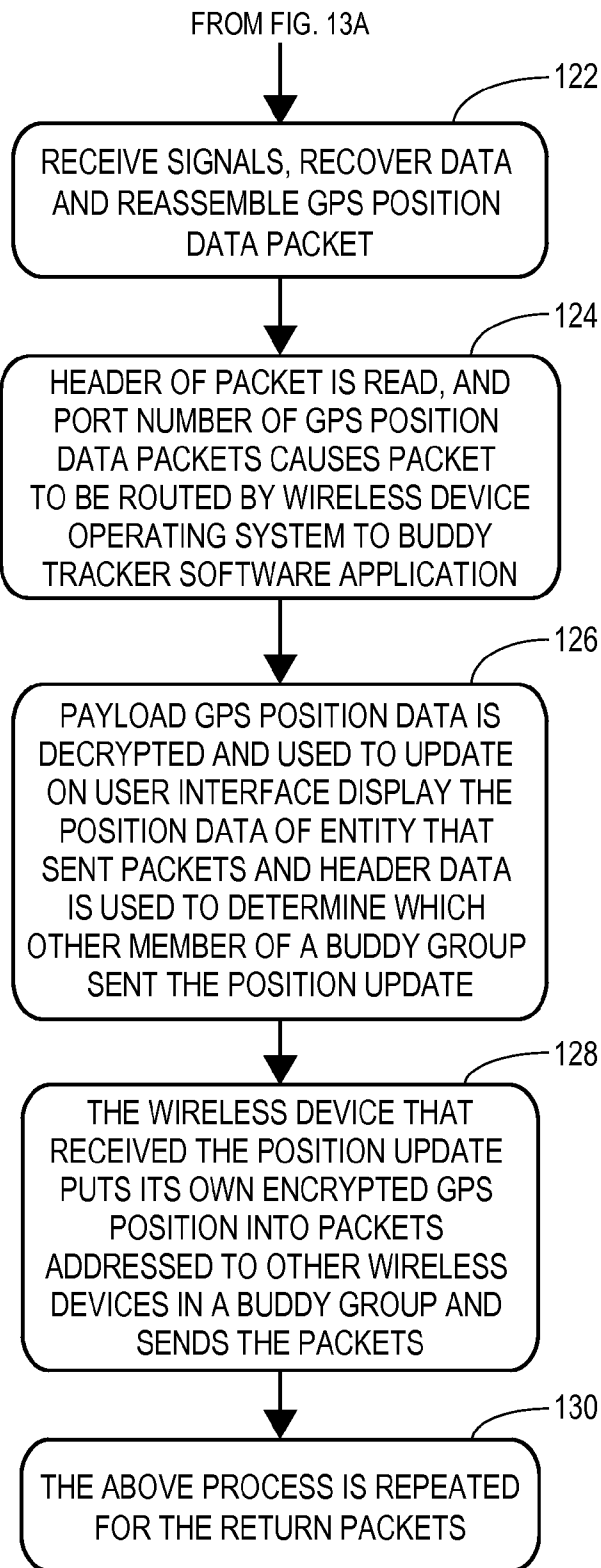
PRIOR ART CELL PHONE SYSTEM  
PEER TO PEER EMBODIMENT

**FIG. 12**

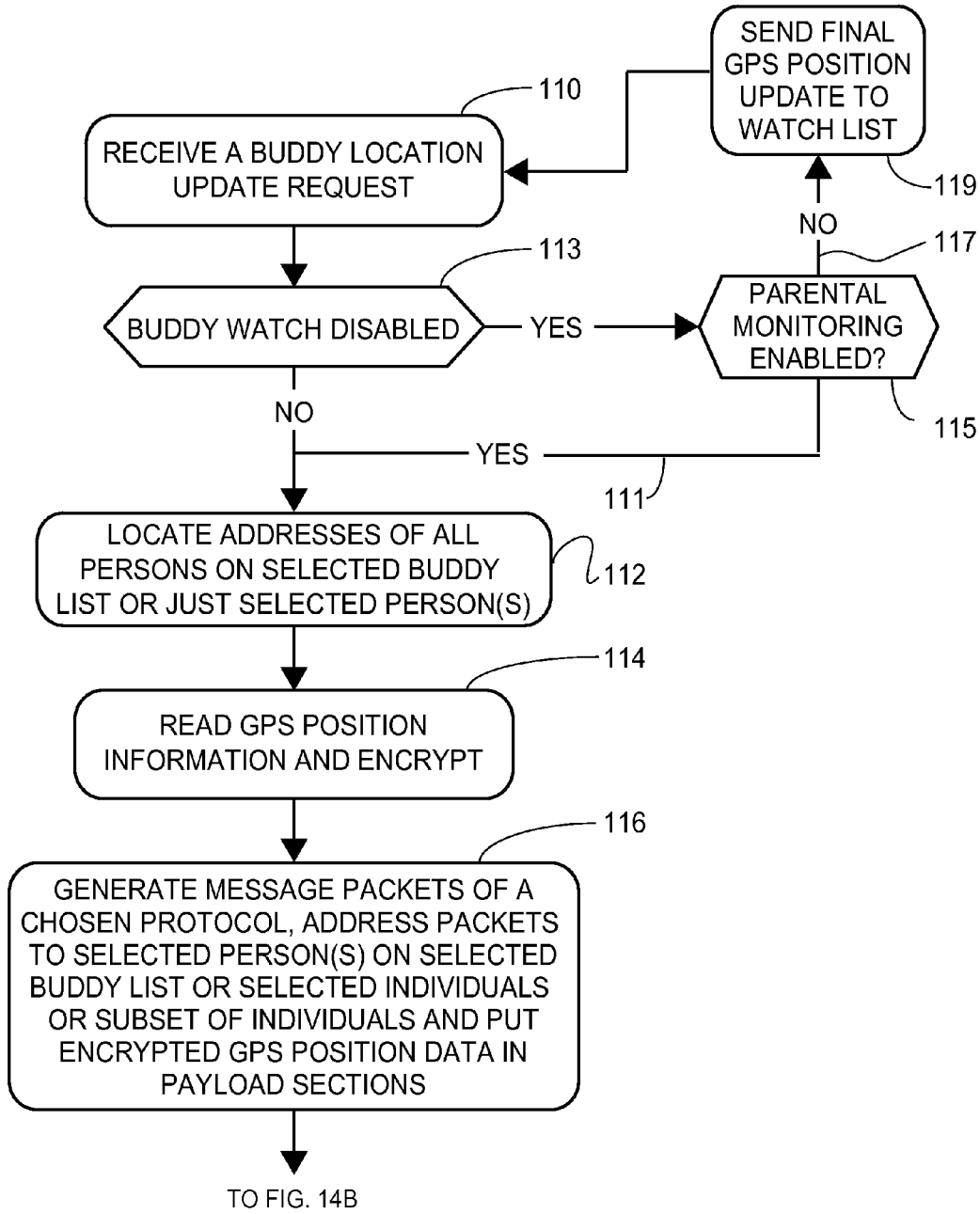


BUDDY WATCH SERVER & CELL PHONE PROCESS TO EXCHANGE POSITION DATA

**FIG. 13A**



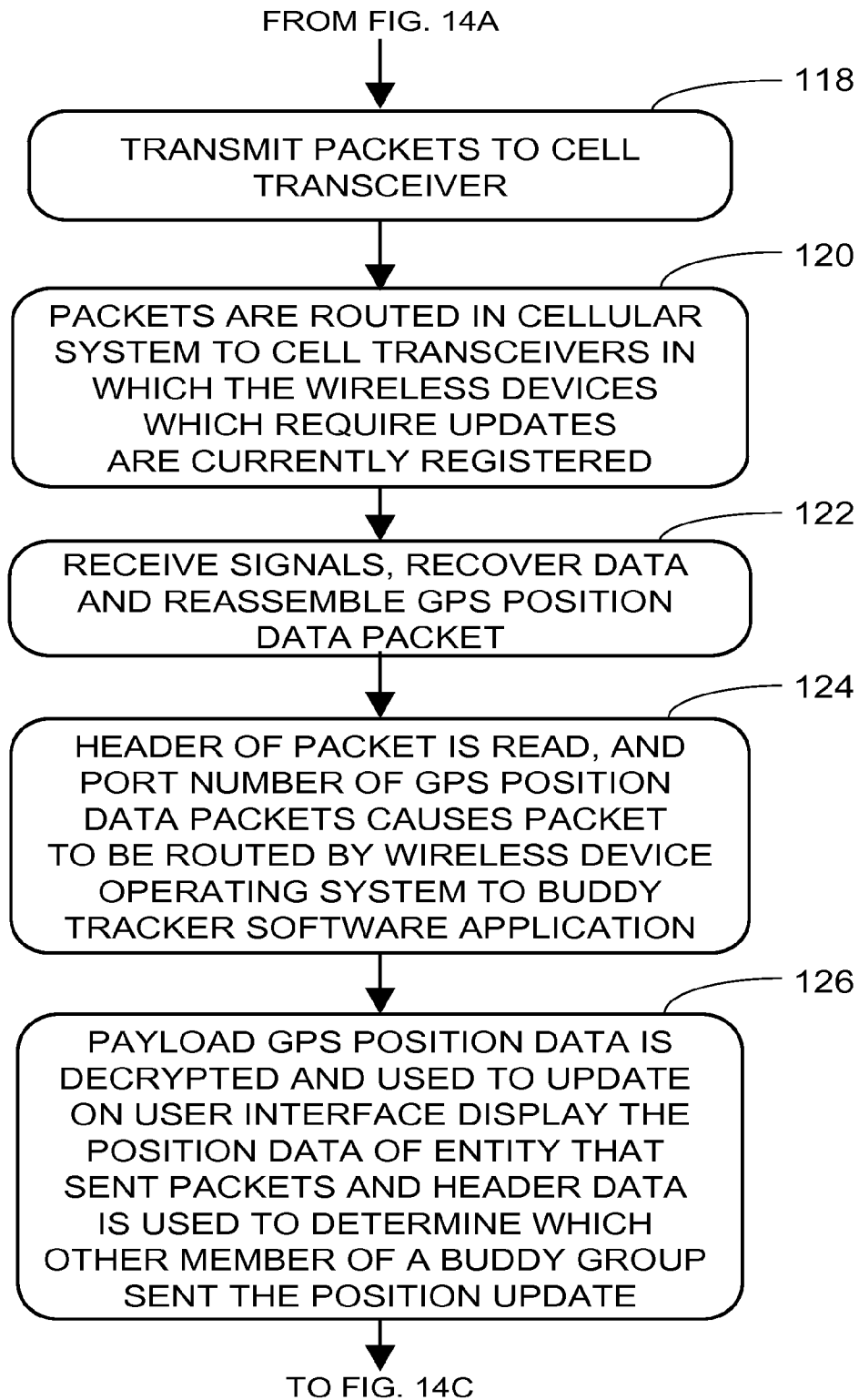
**FIG. 13B**



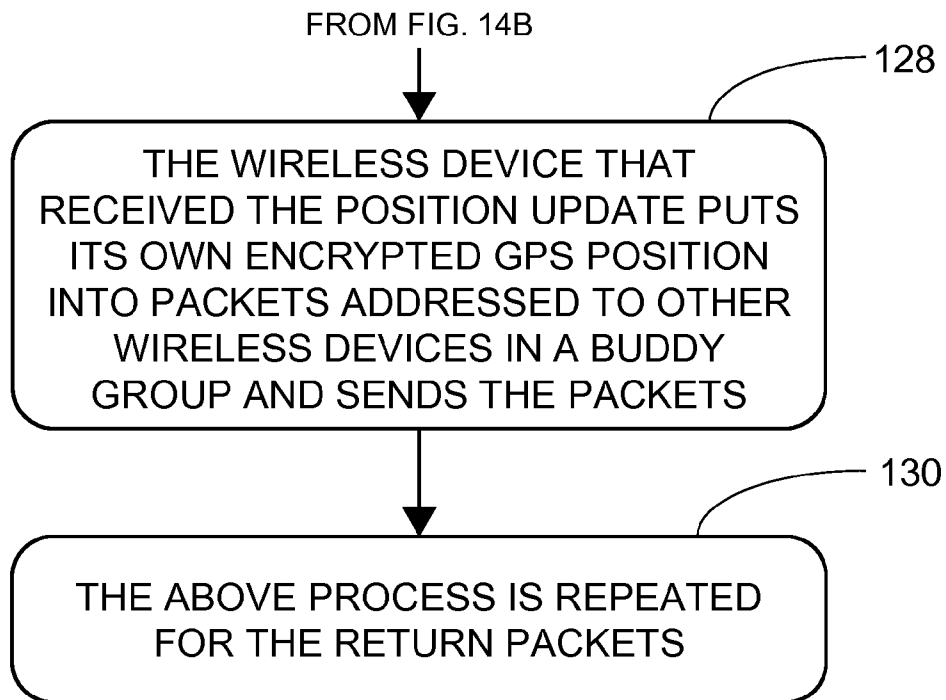
ALT. EMB. OF POSITION EXCHANGE PROCESS

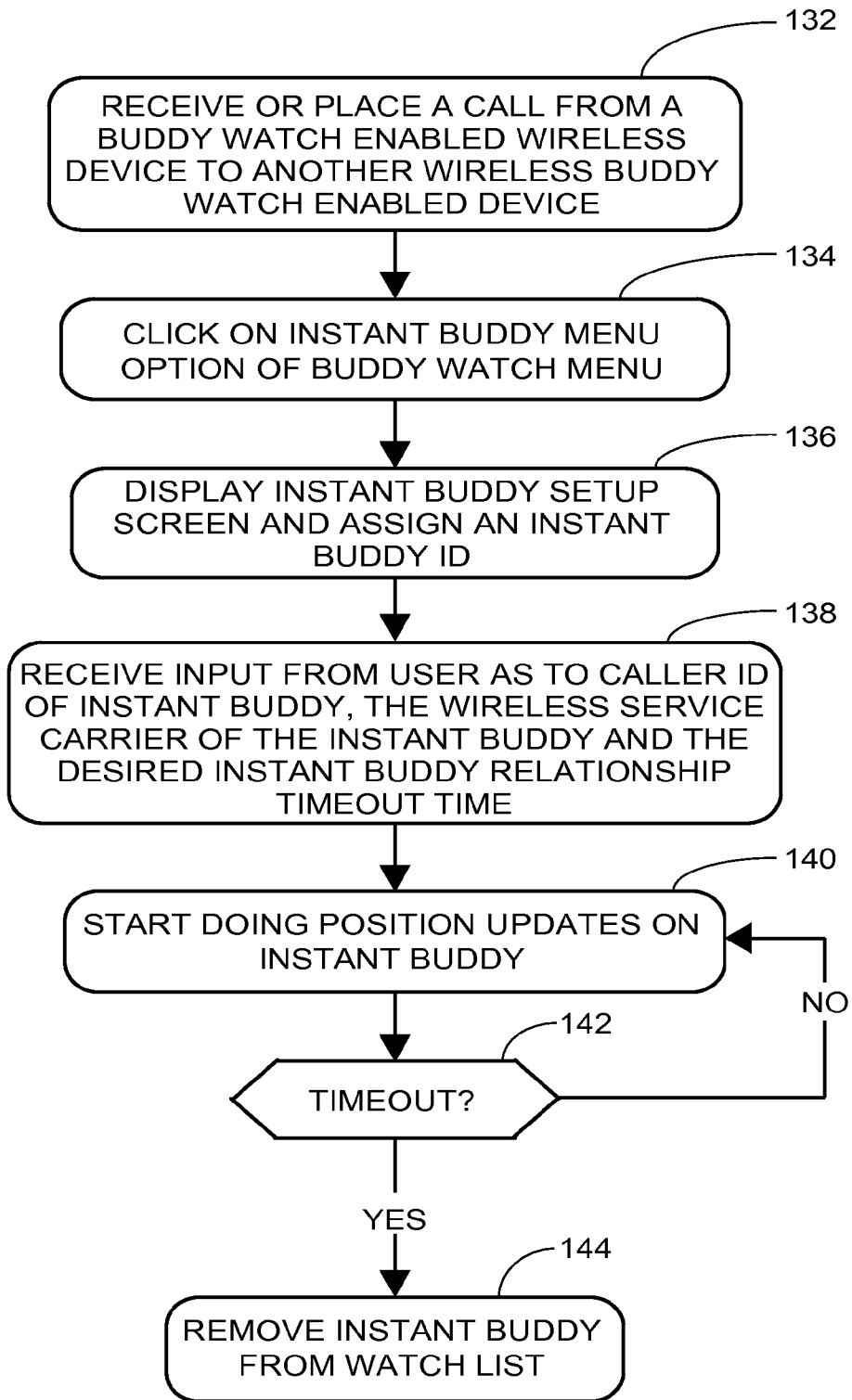
**FIG. 14A**



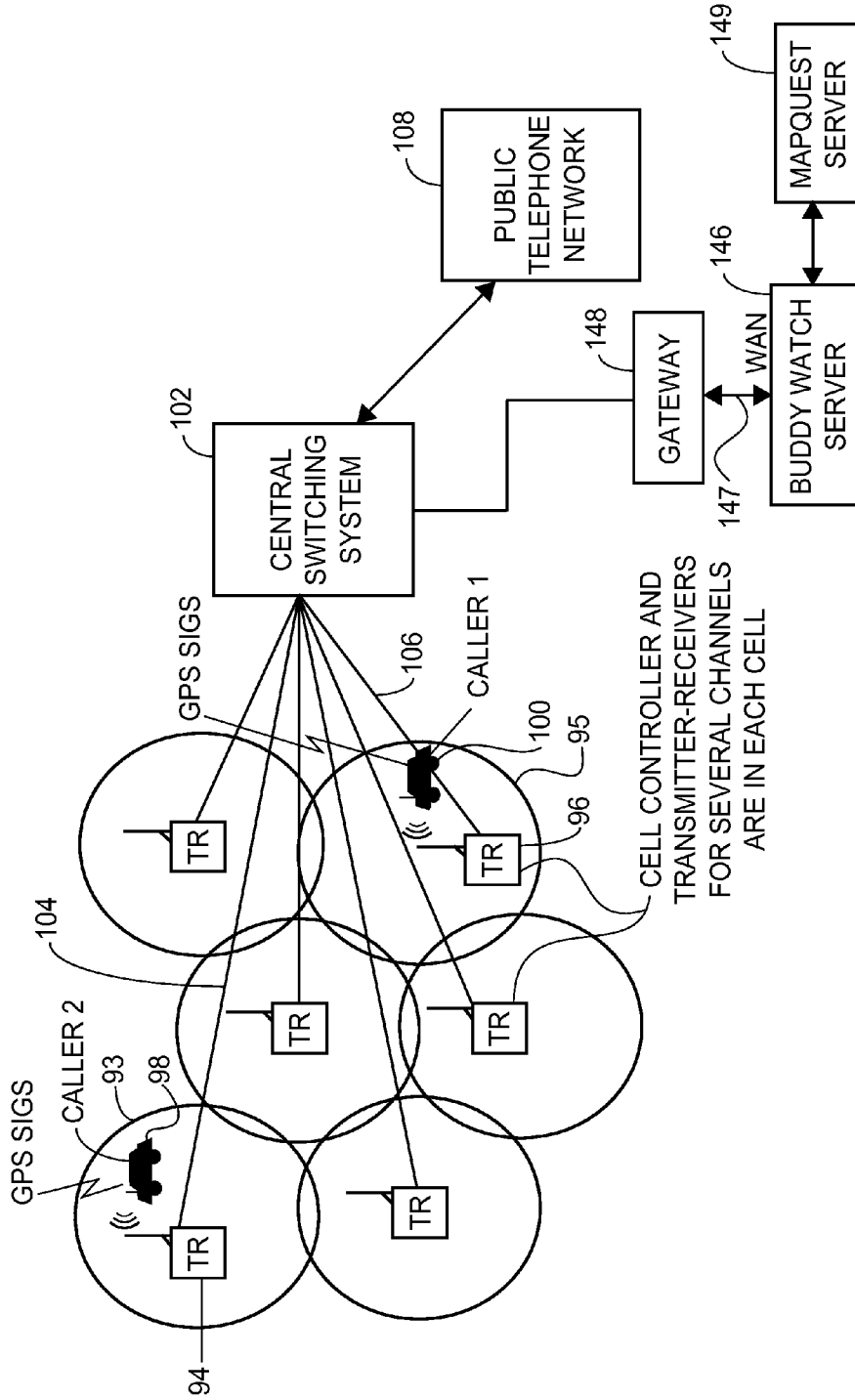


**FIG. 14B**

**FIG. 14C**



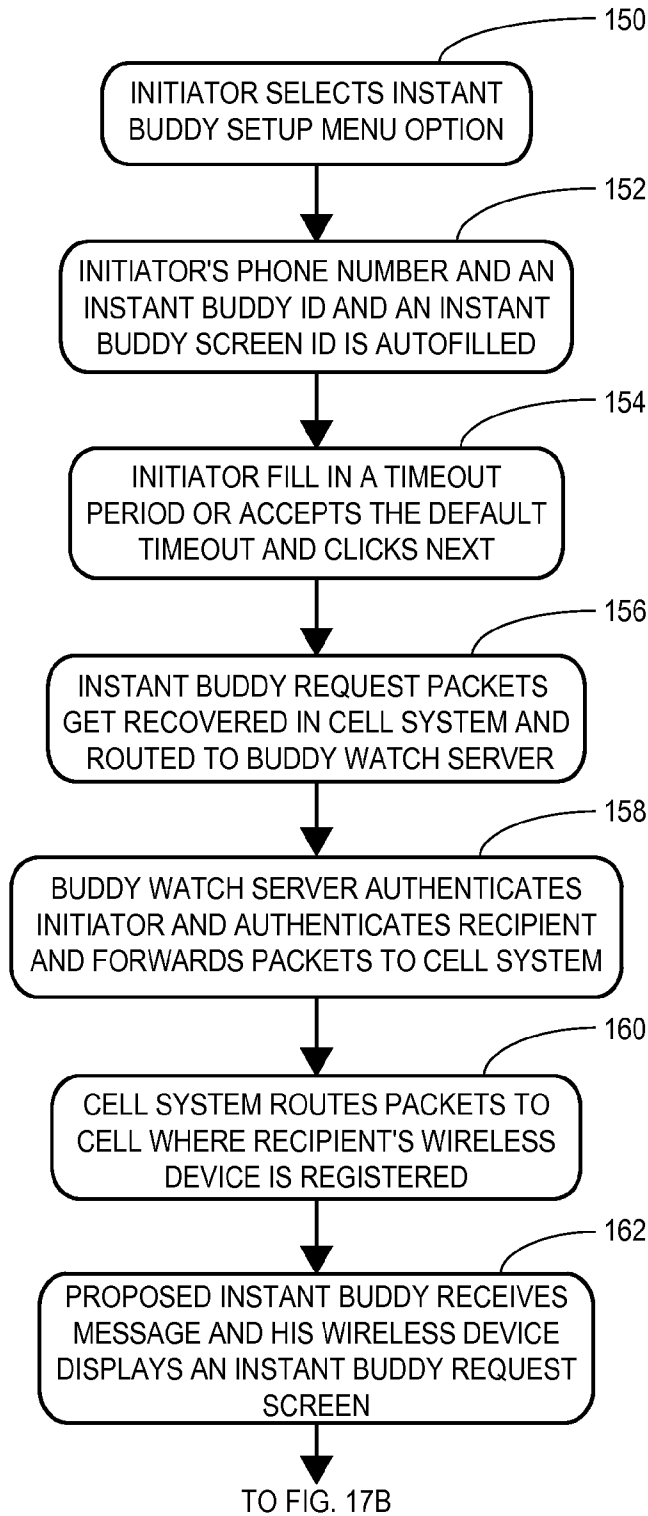
**FIG. 15**



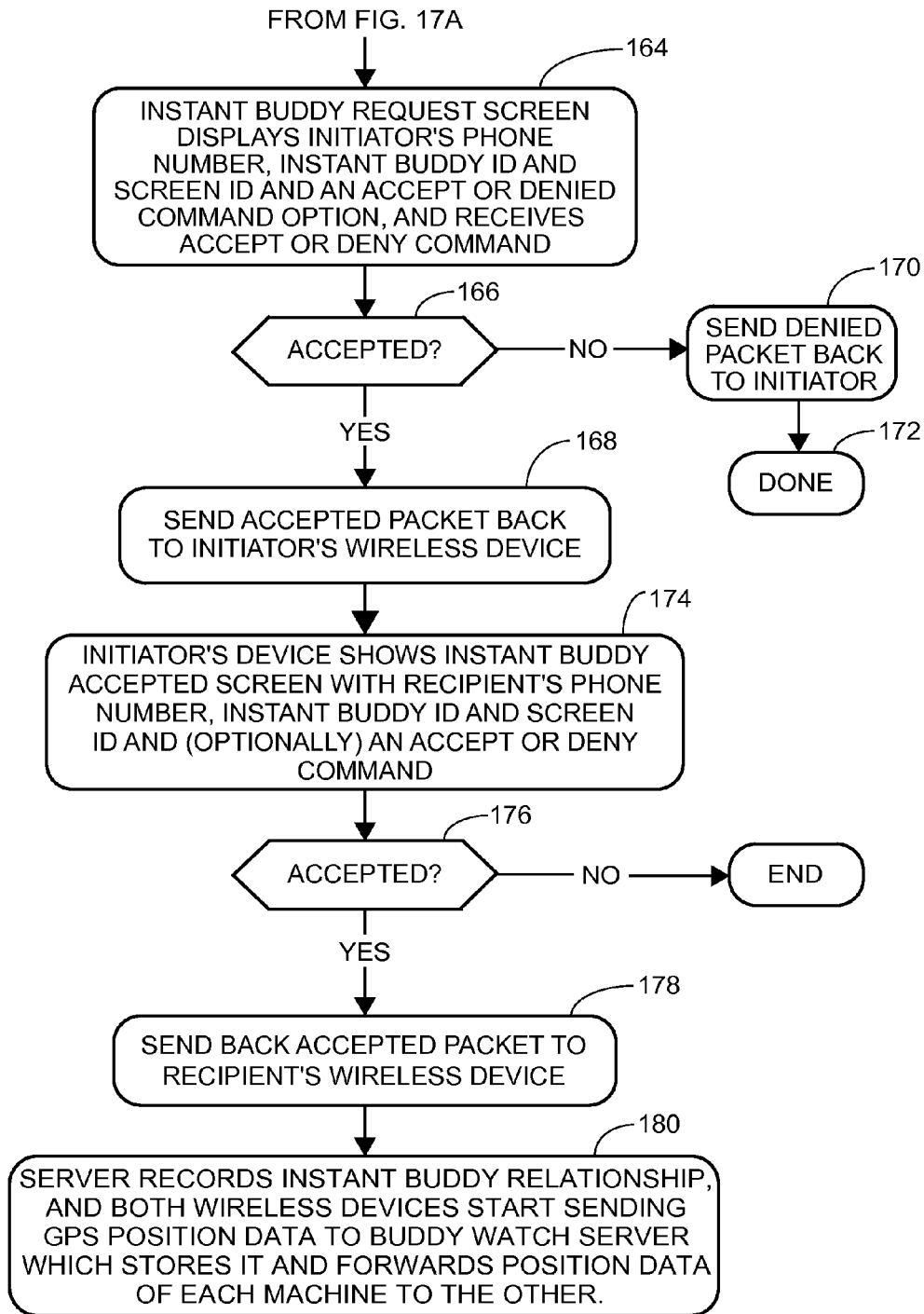
**FIG. 16**

SERVER-BASED BUDDY WATCH SYSTEM

PREFERRED INSTANT BUDDY SETUP PROCESS



**FIG. 17A**



**FIG. 17B**

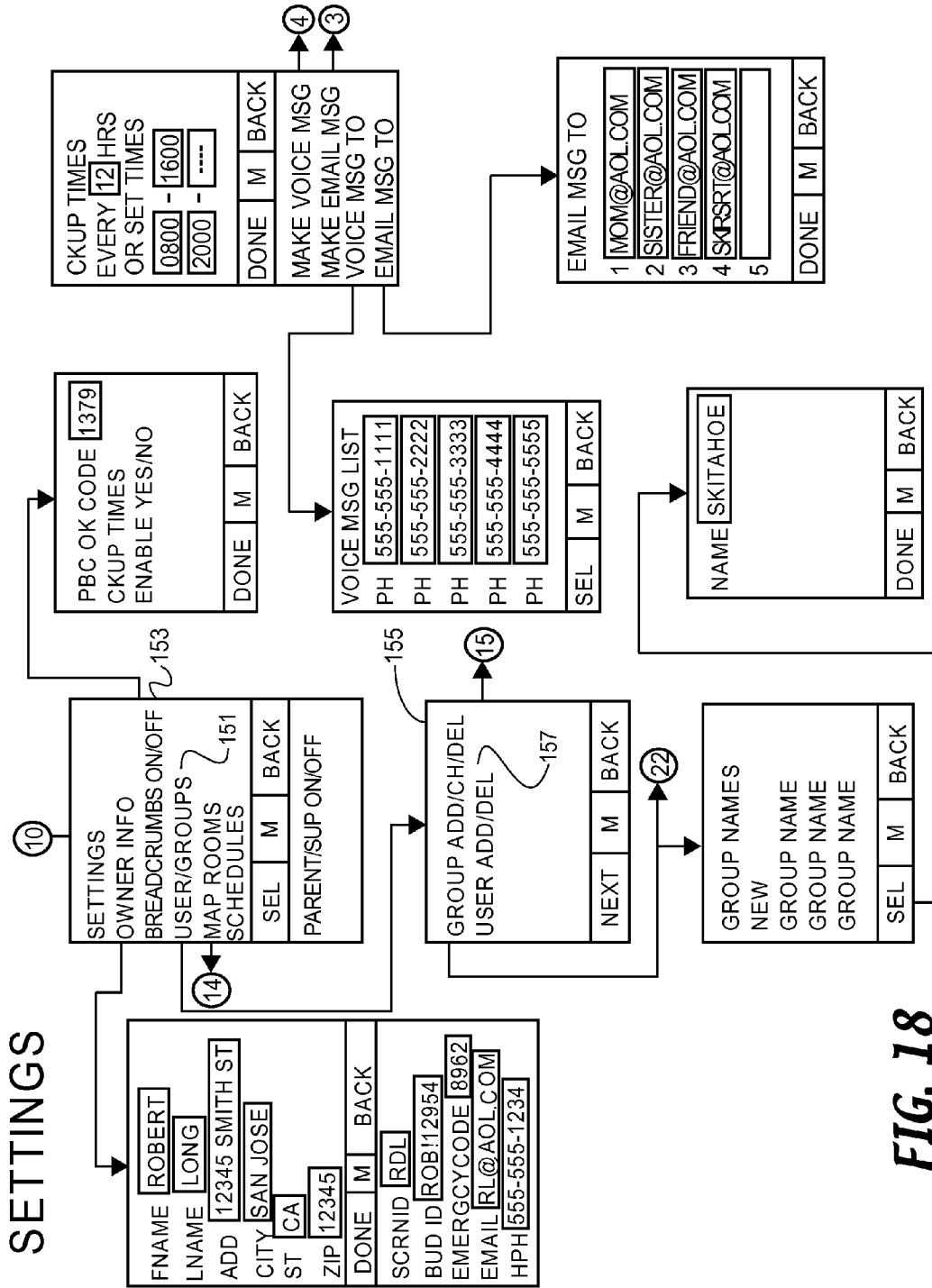


FIG. 18

# CREATE AN INSTANT BUDDY

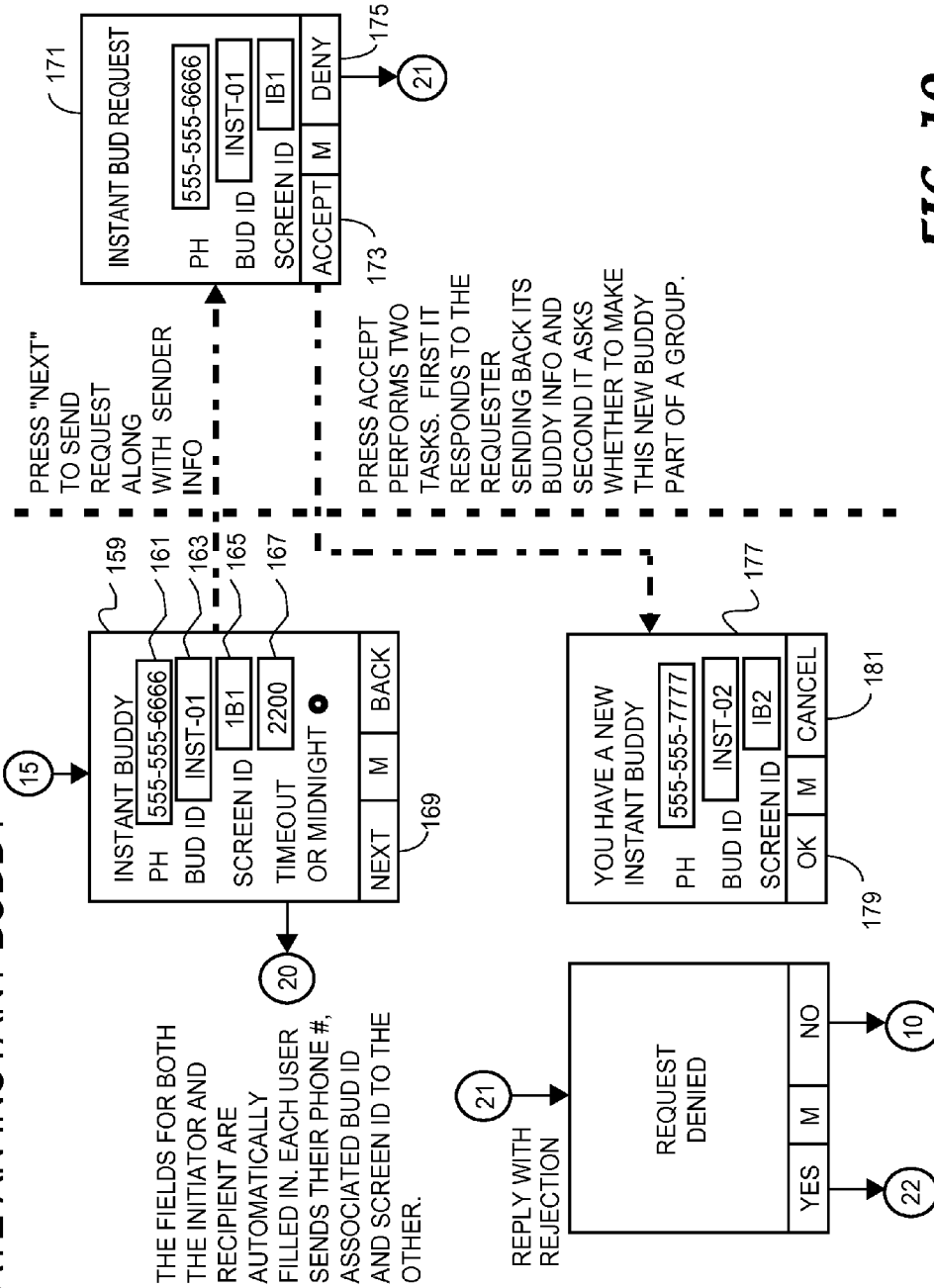
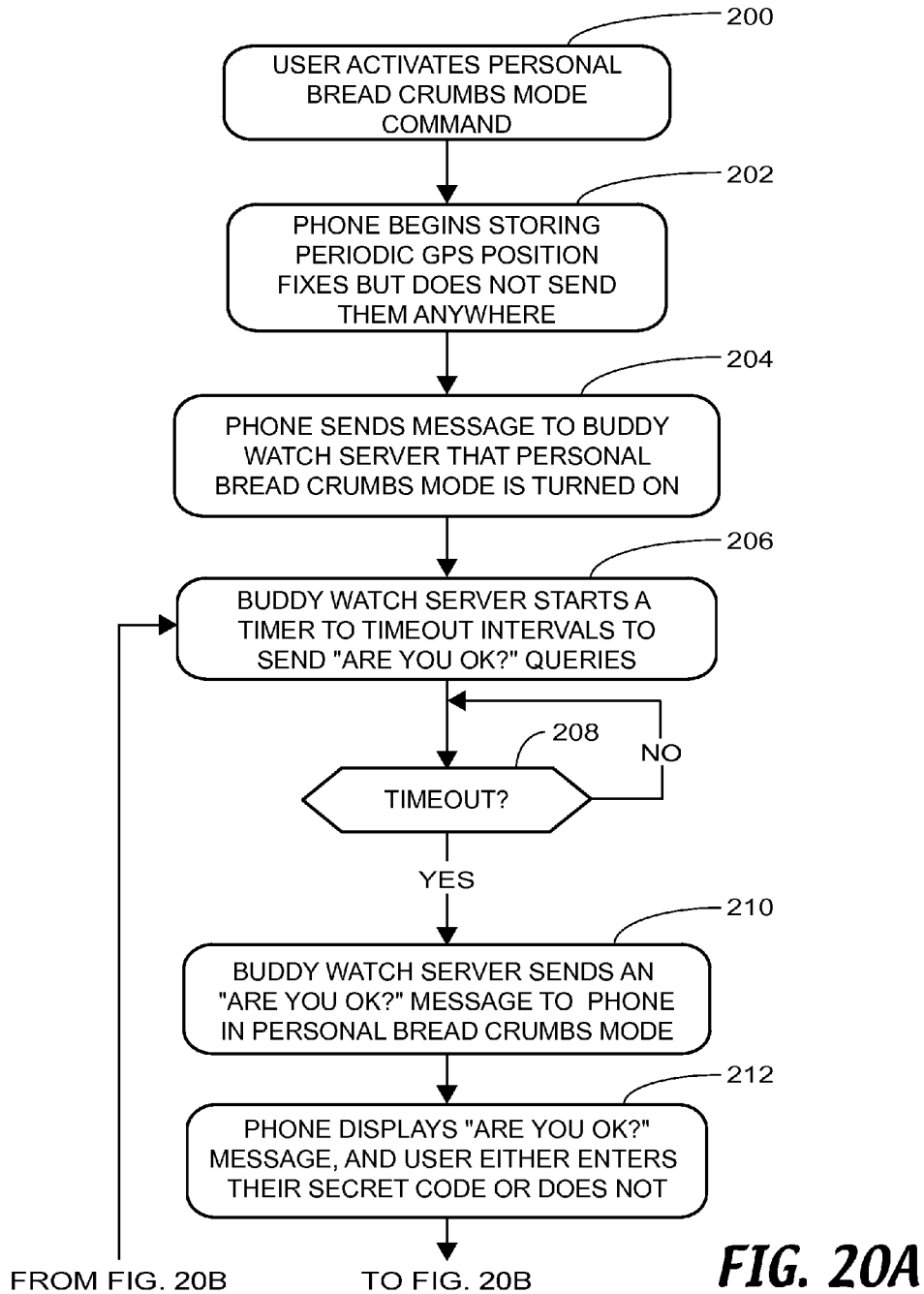
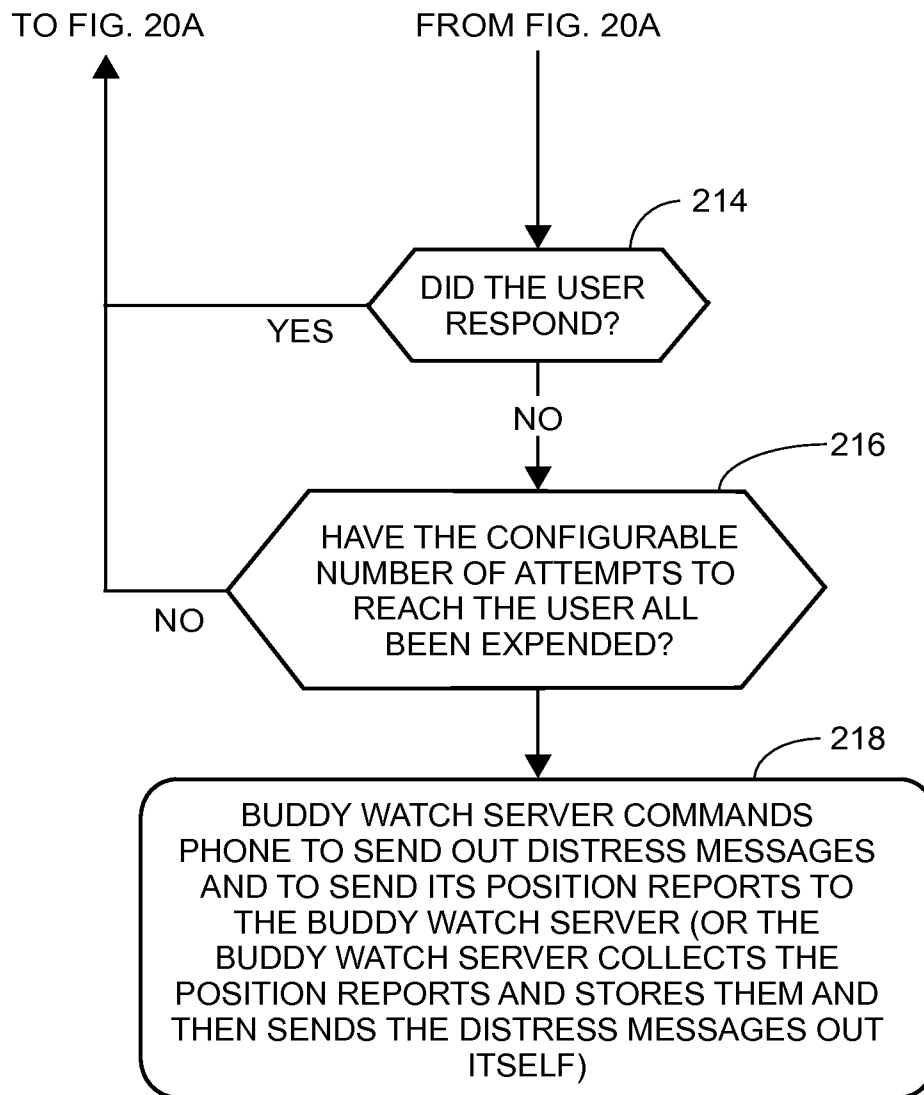


FIG. 19

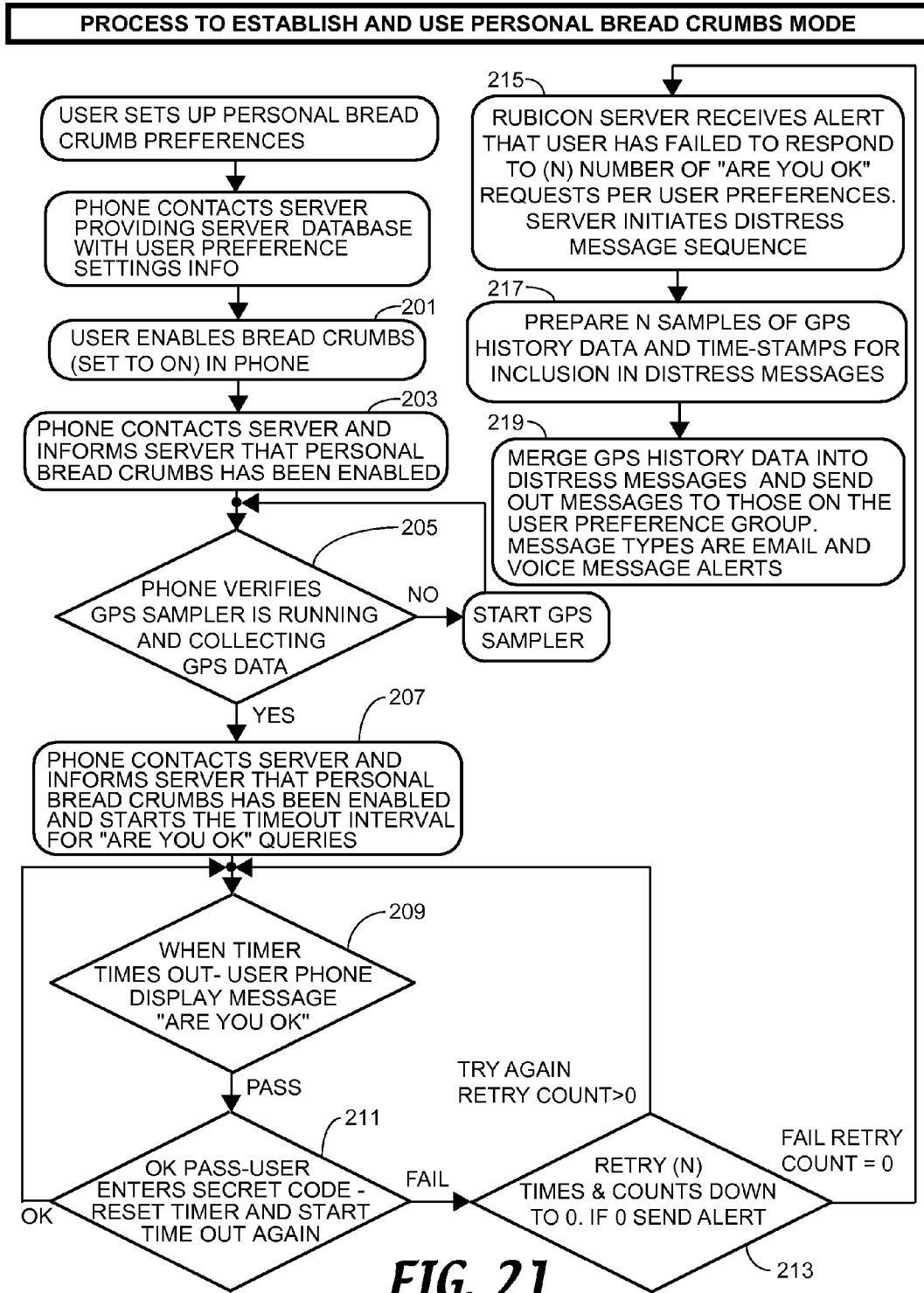


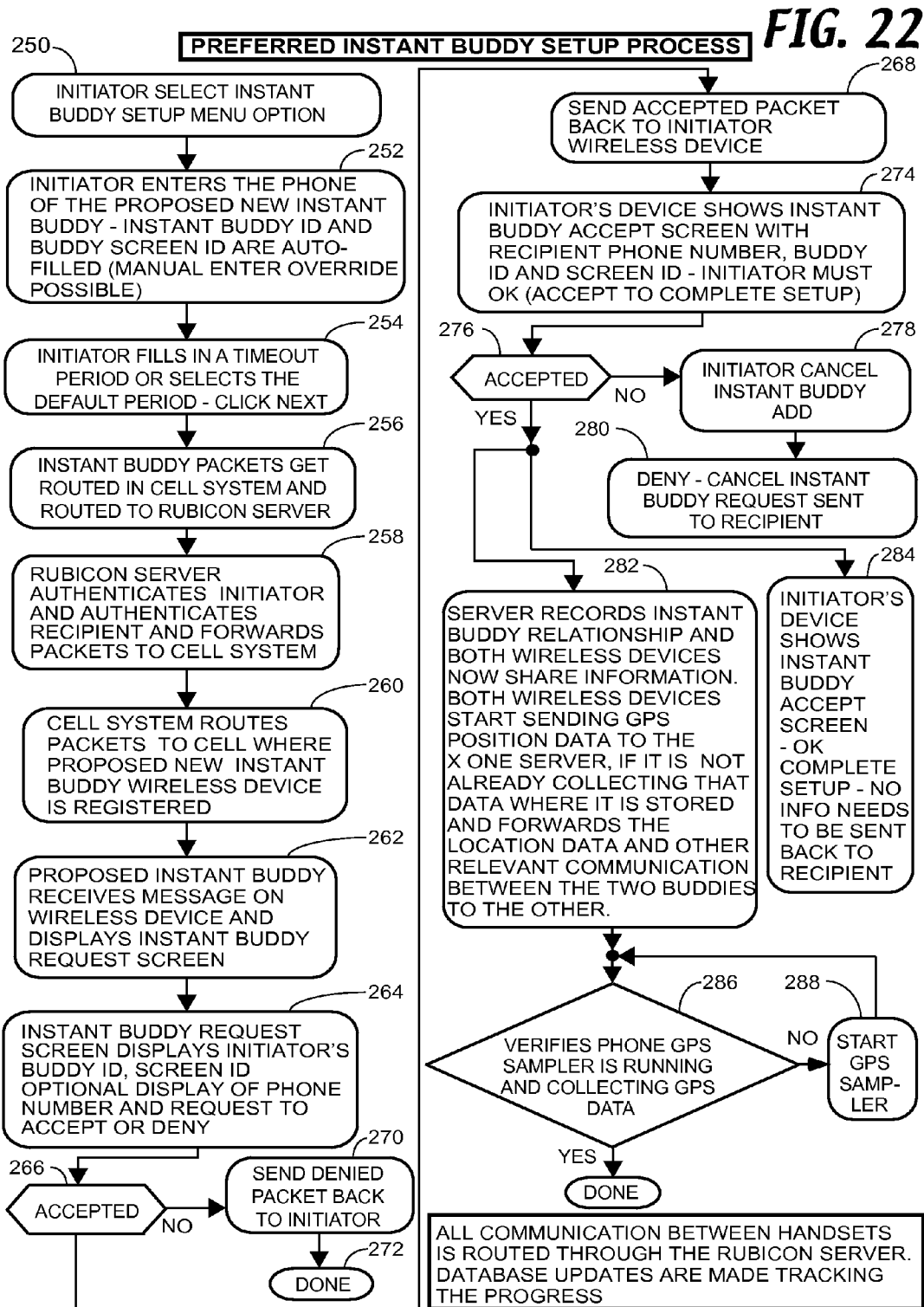
PROCESS TO ESTABLISH AND USE PERSONAL BREAD CRUMBS MODE

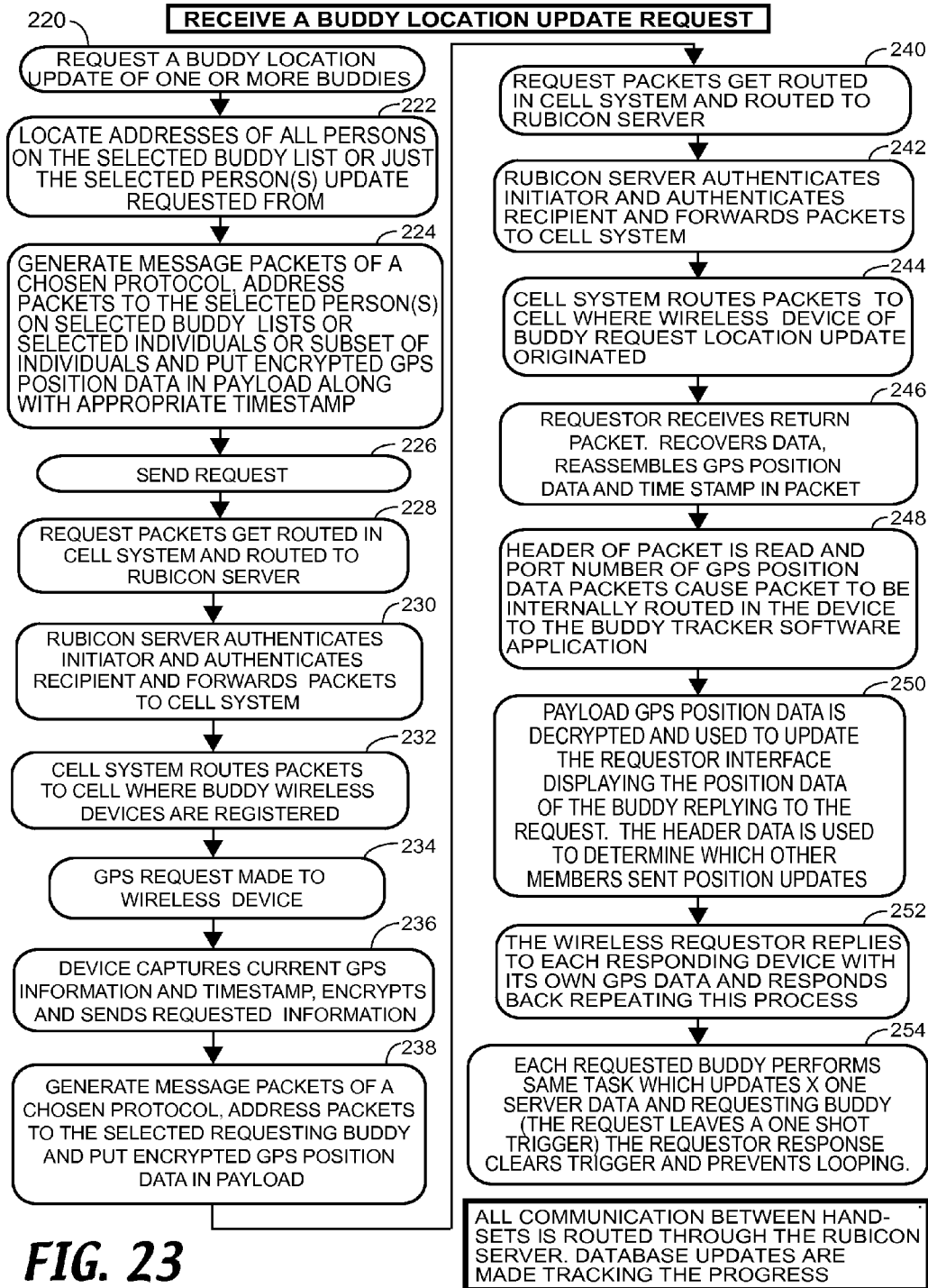


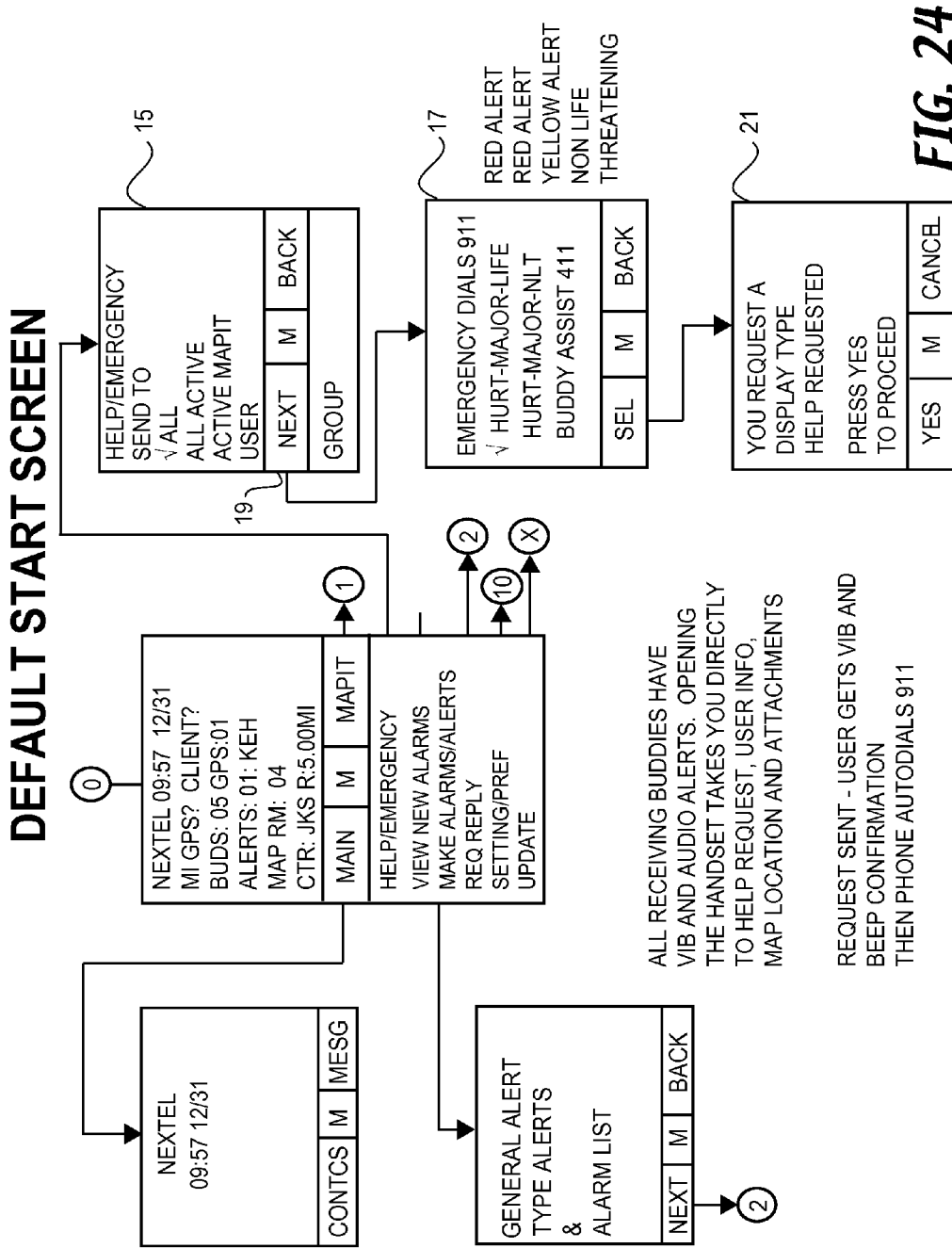


**FIG. 20B**









**FIG. 24**

# HELP

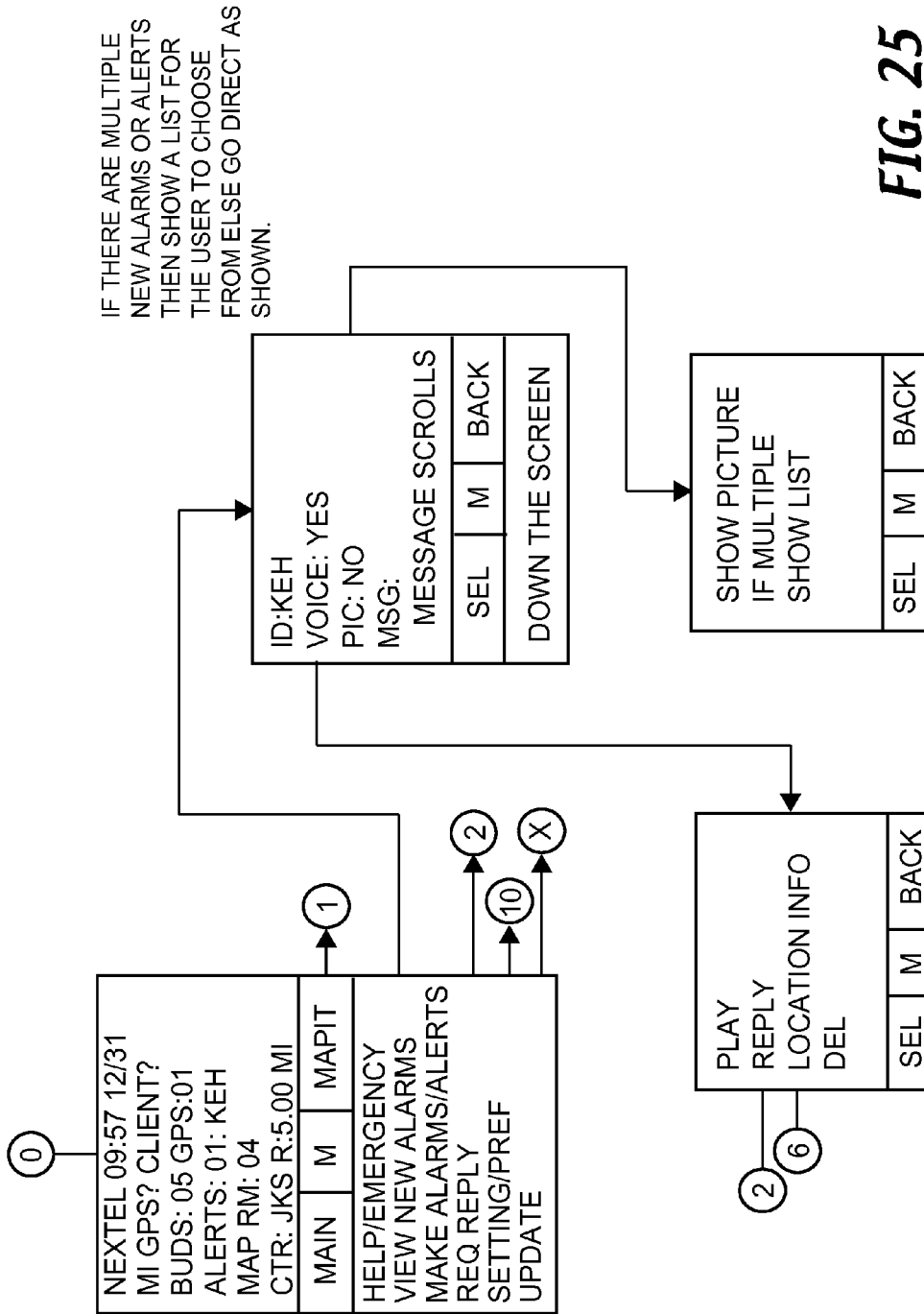


FIG. 25

# MAPIT

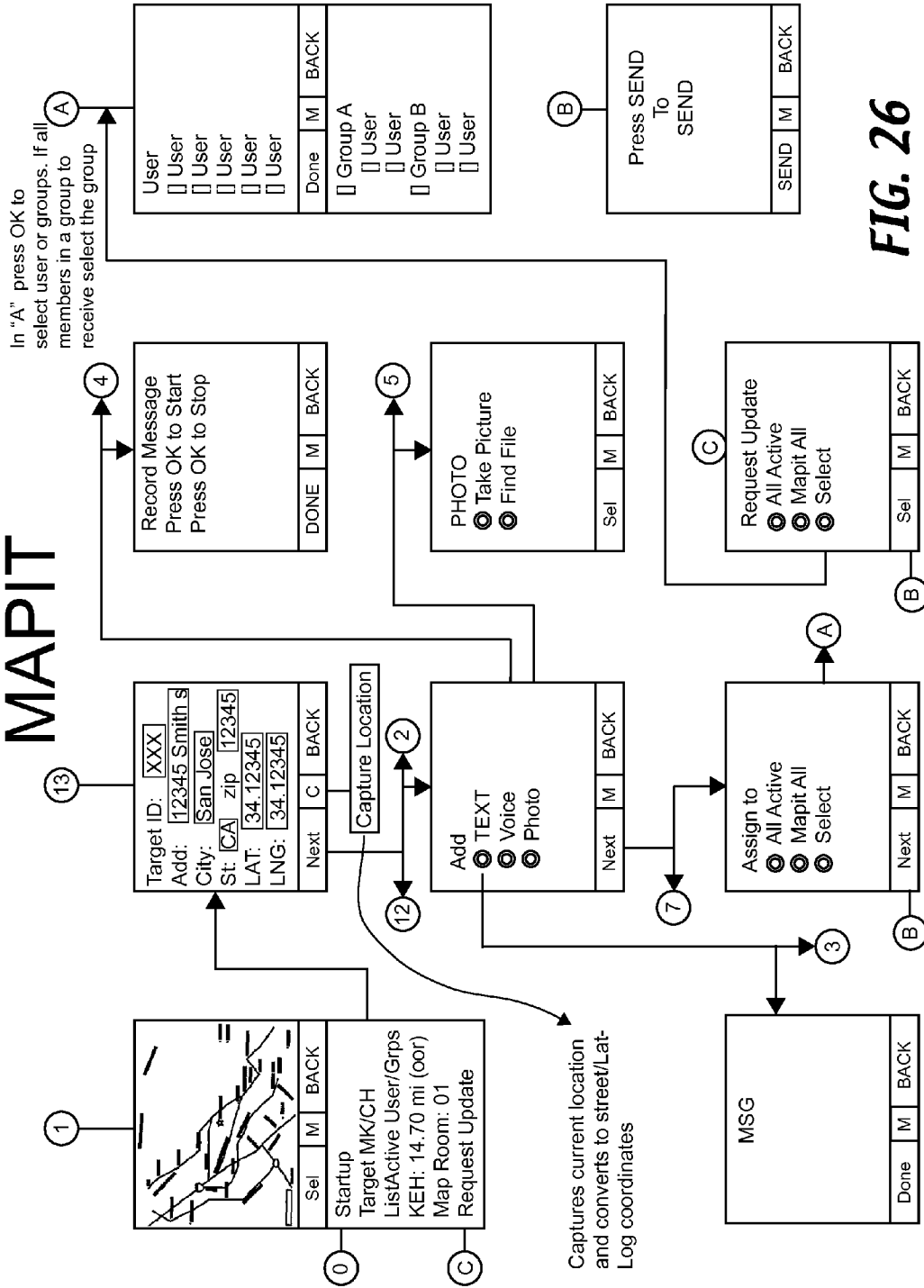


FIG. 26



# RECENTER ON USER

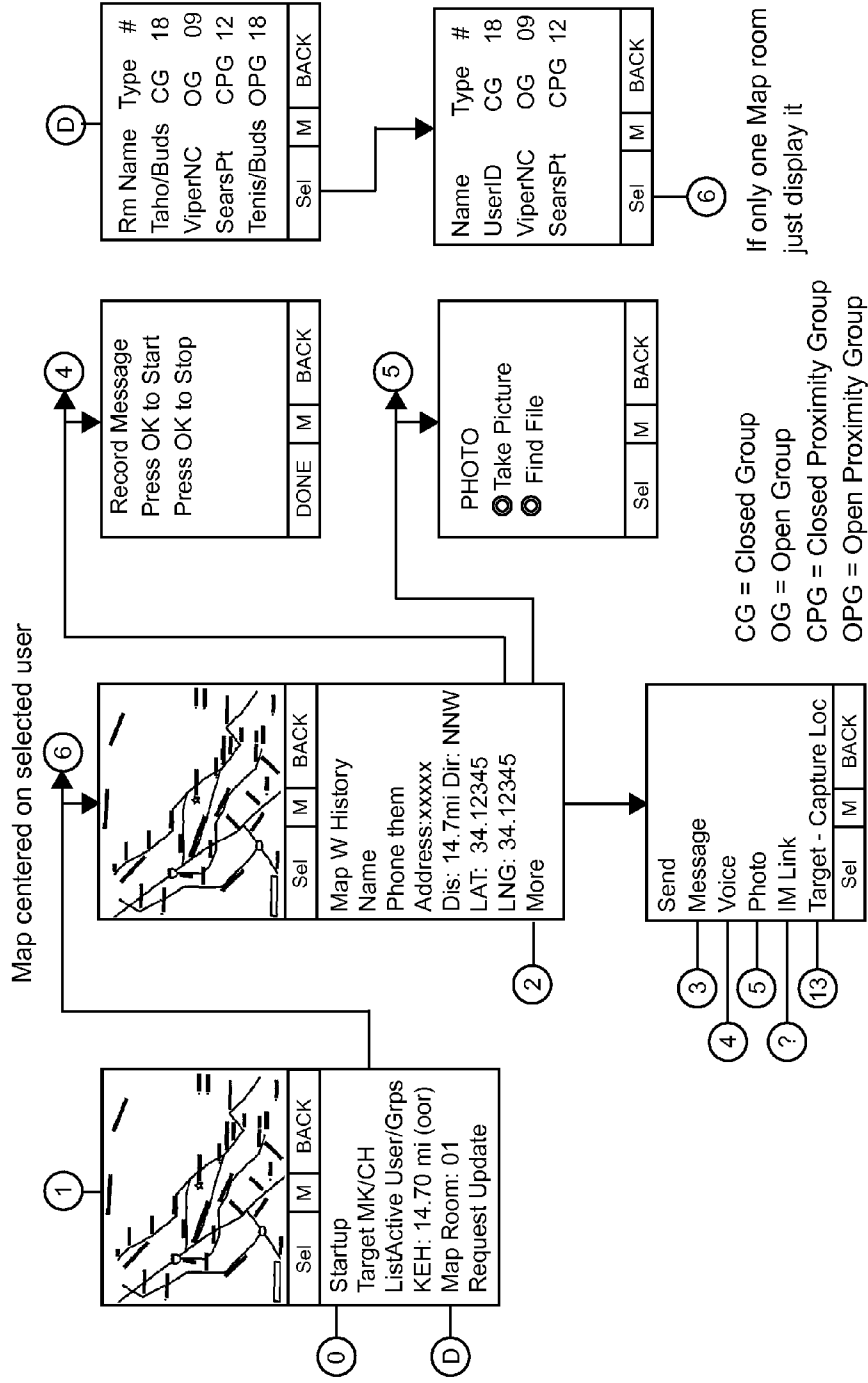
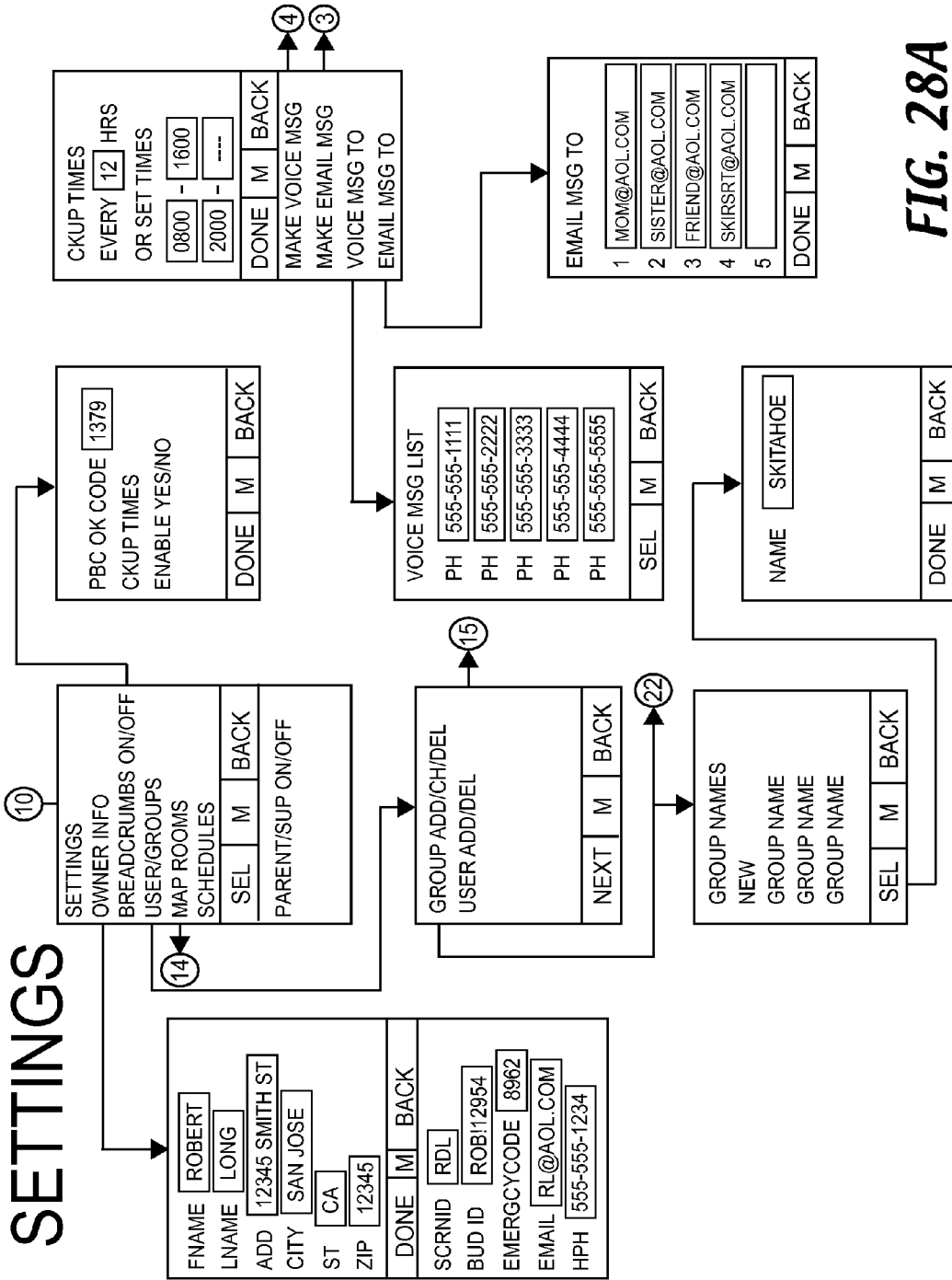


FIG. 27



**FIG. 28A**

# SETTINGS (CONT)

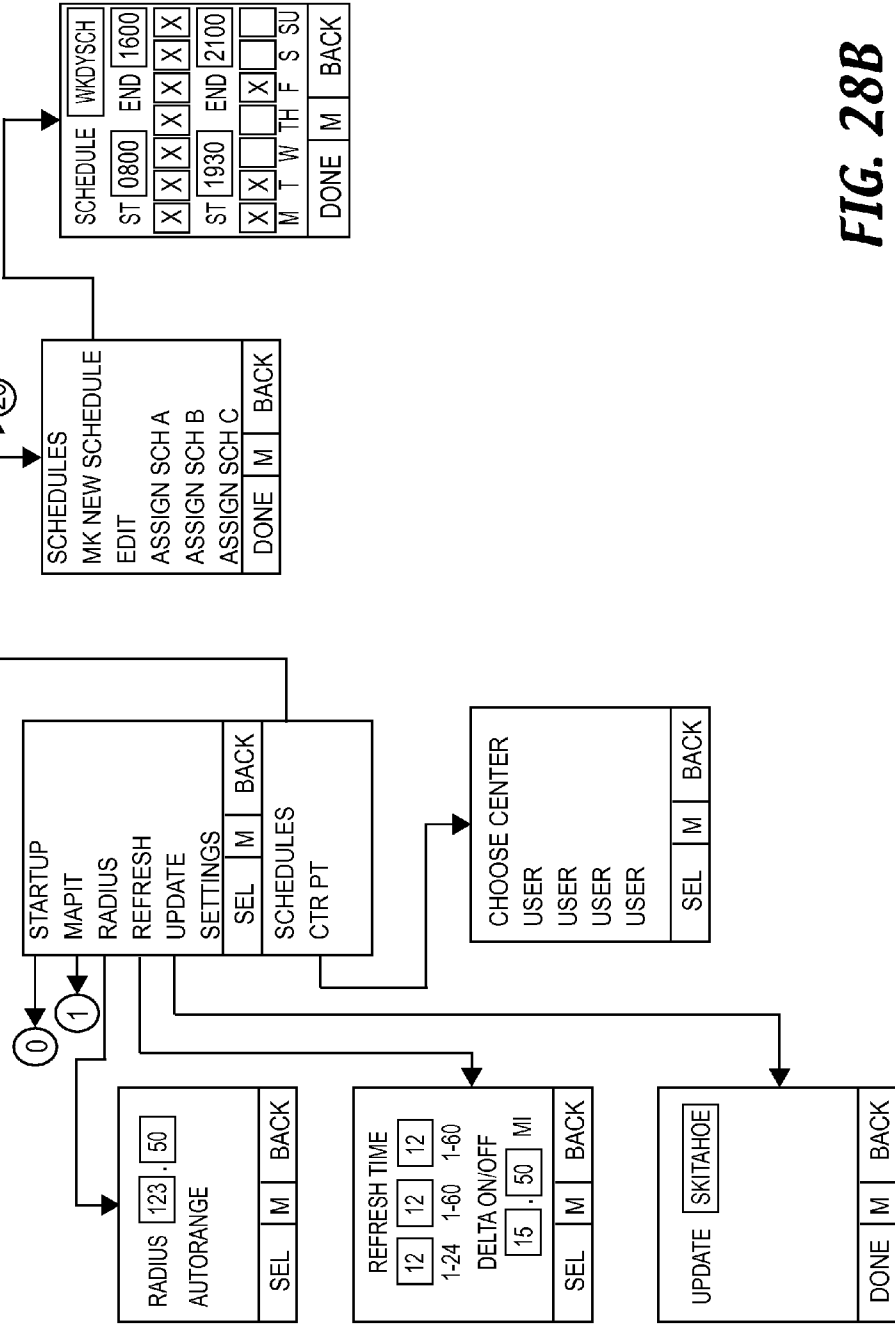


FIG. 28B

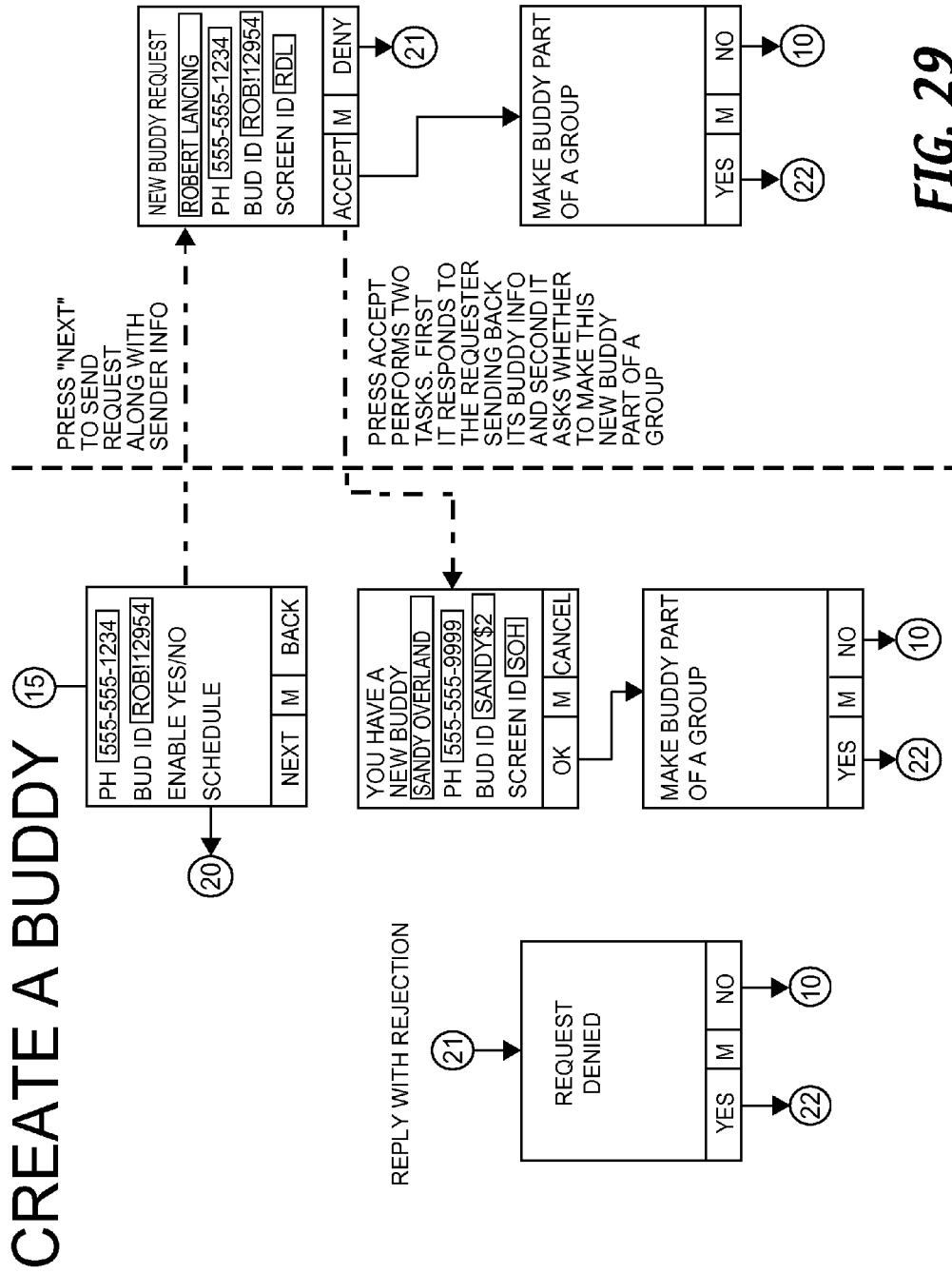


FIG. 29

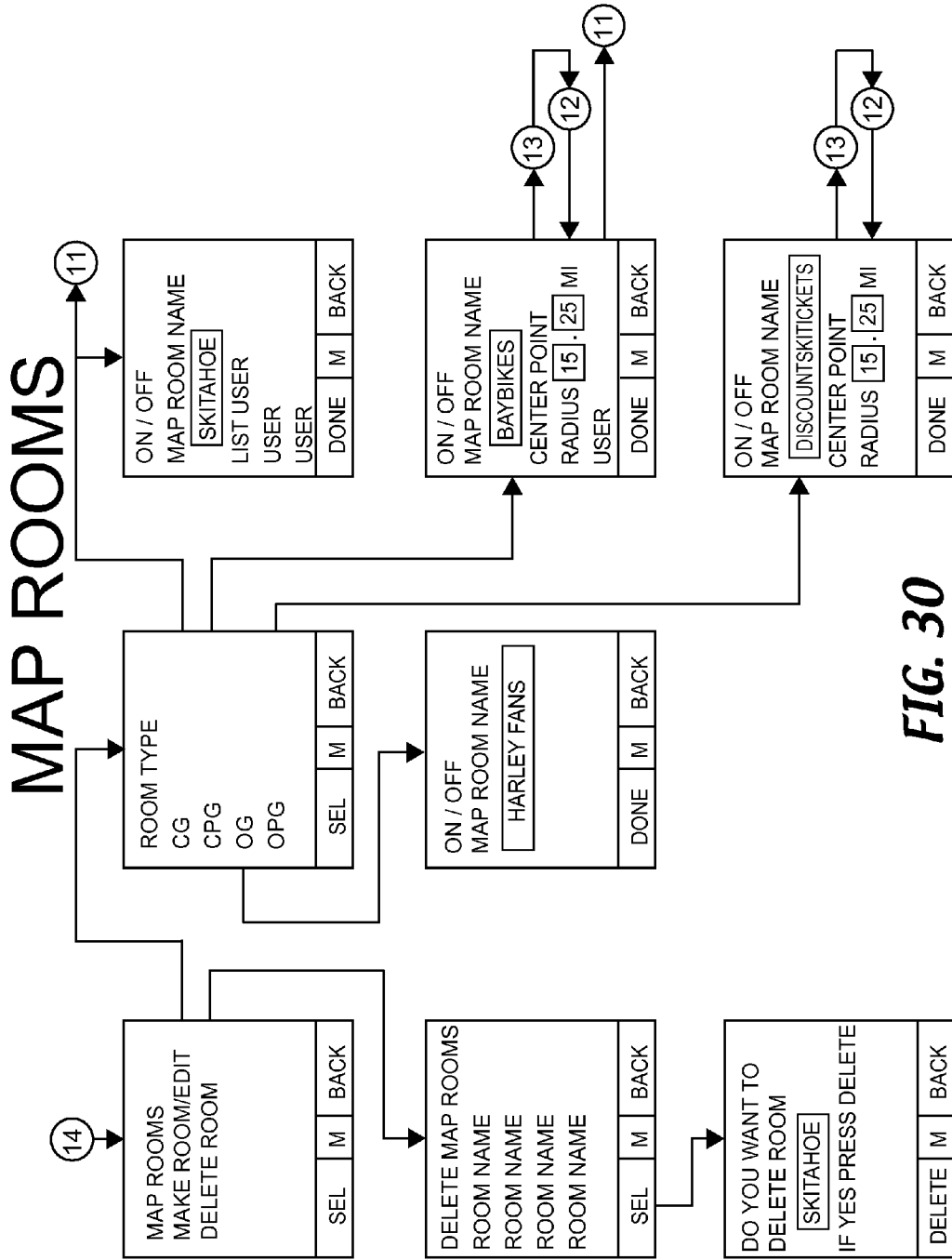
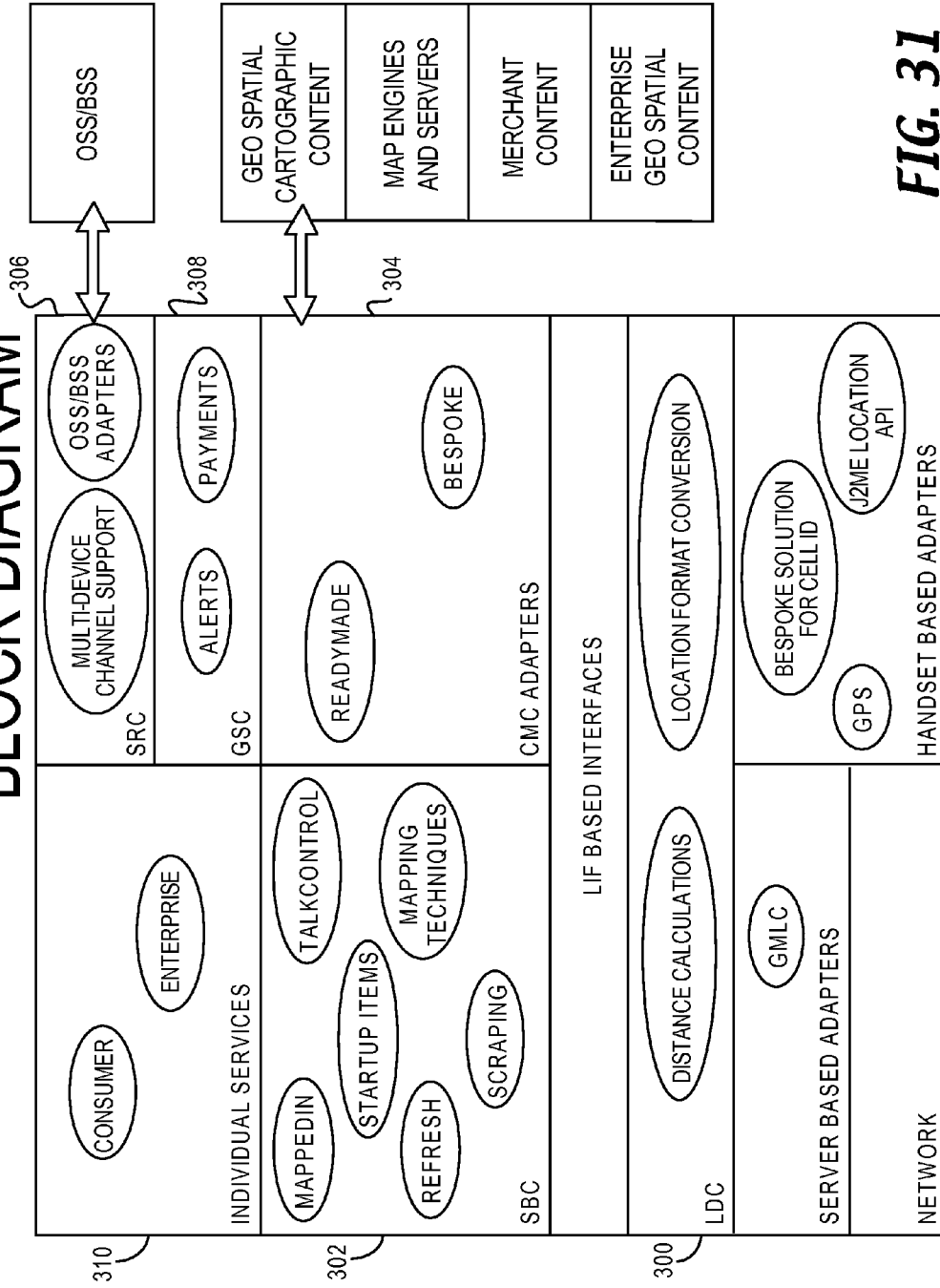
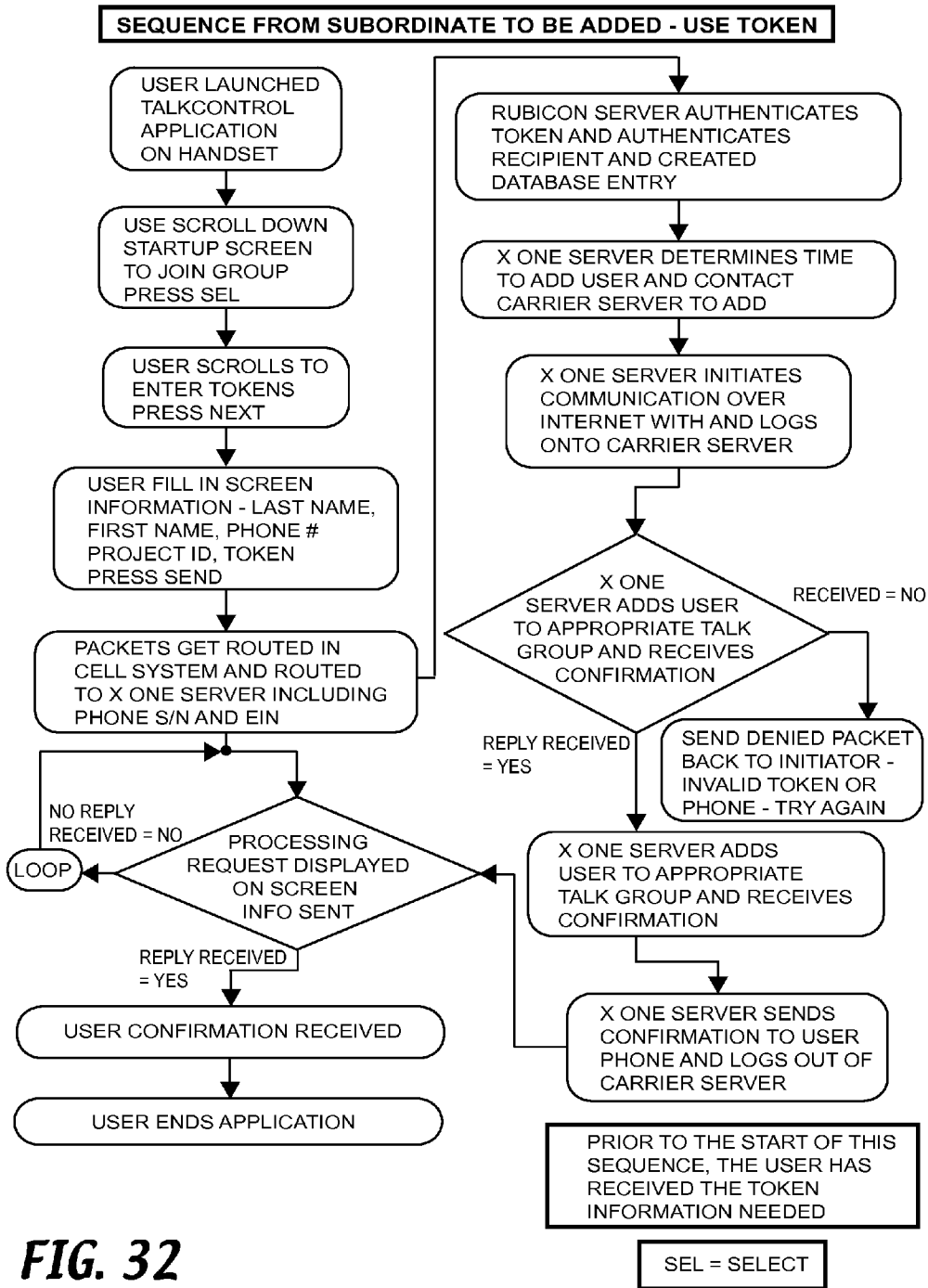


FIG. 30

# BLOCK DIAGRAM

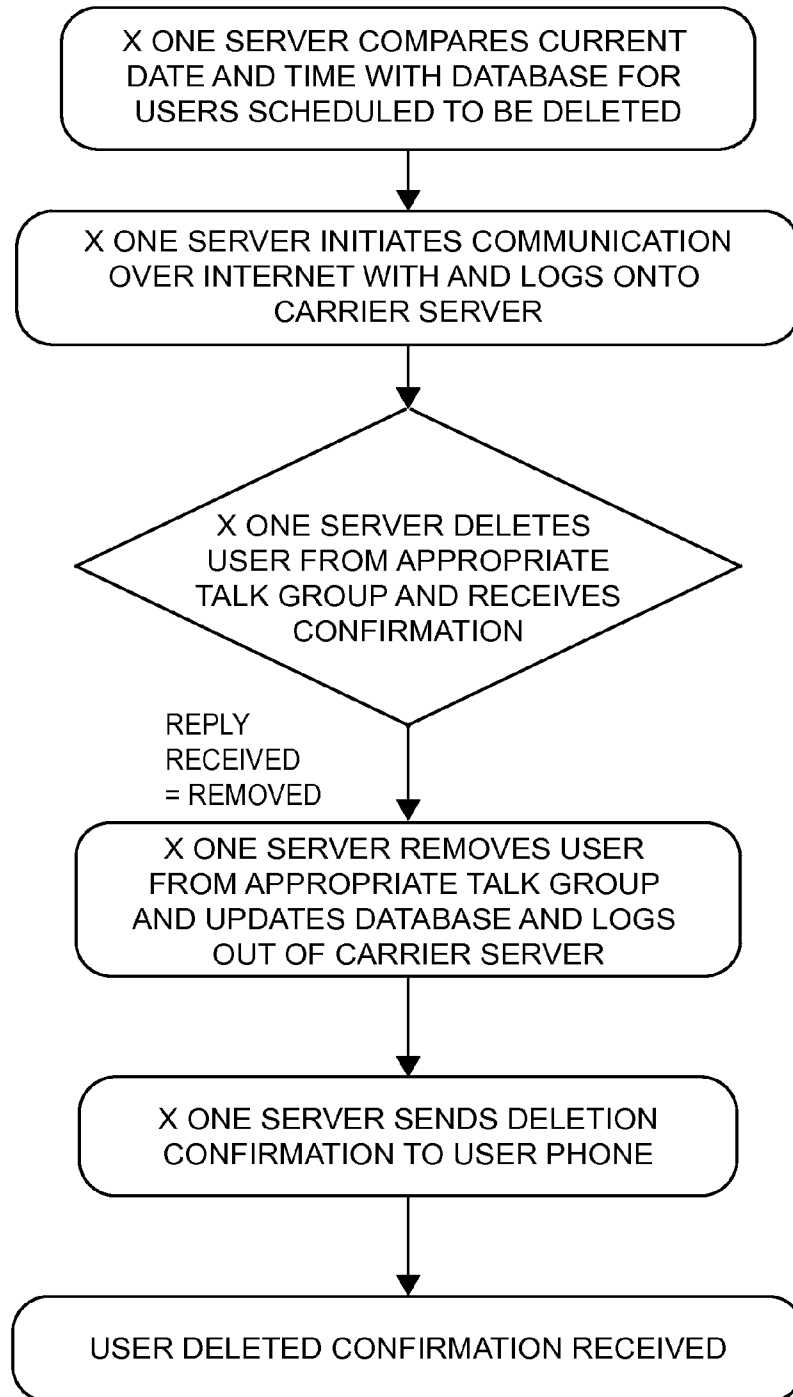


**FIG. 31**



**FIG. 32**

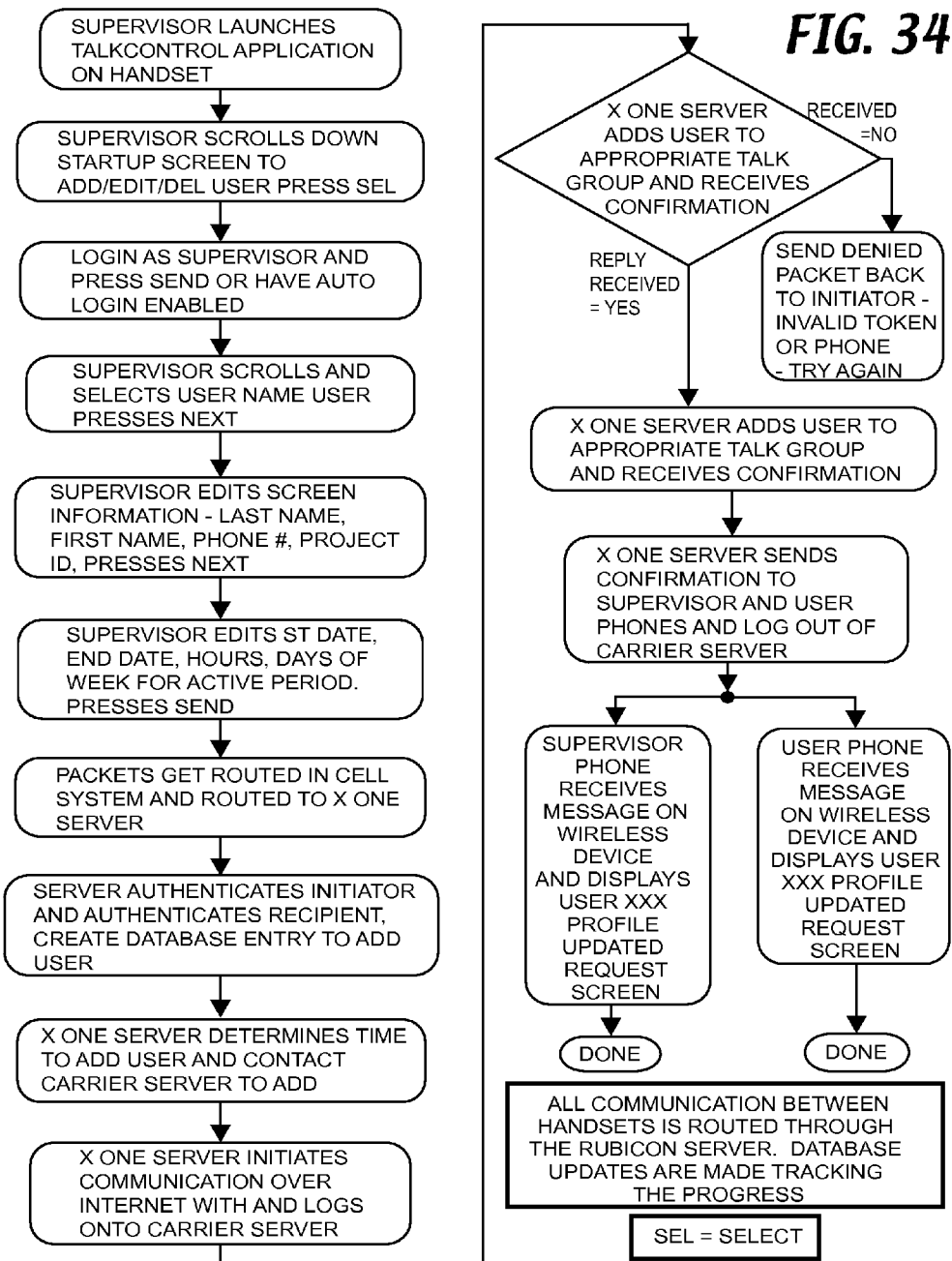
**SEQUENCE FROM SERVER TO AUTO DELETE A USER - SCHEDULE**



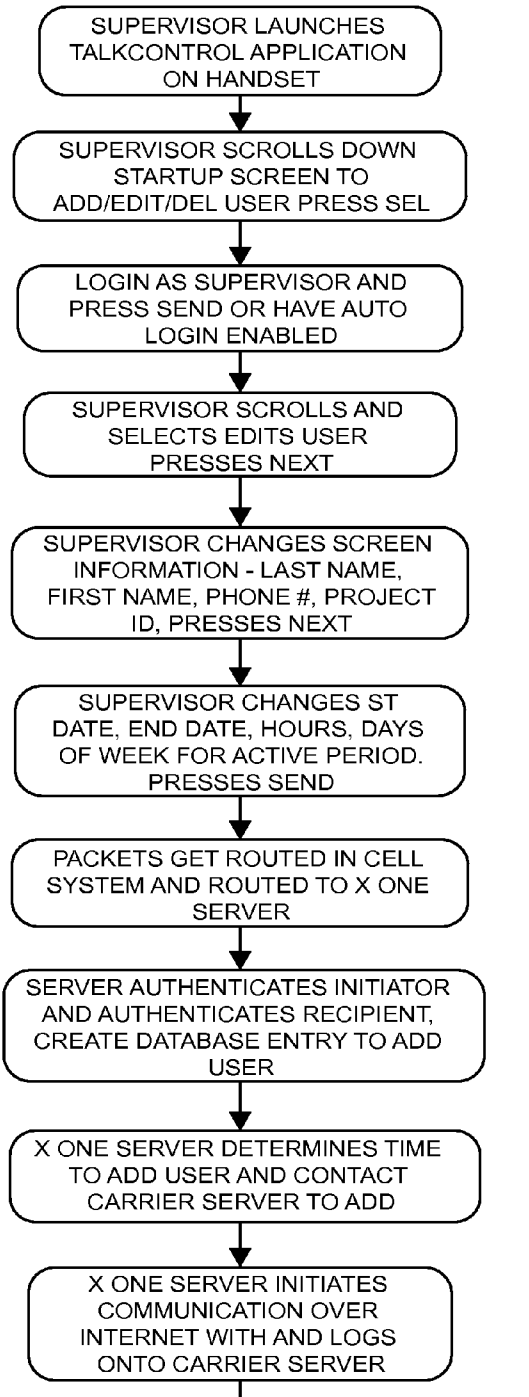
**FIG. 33**



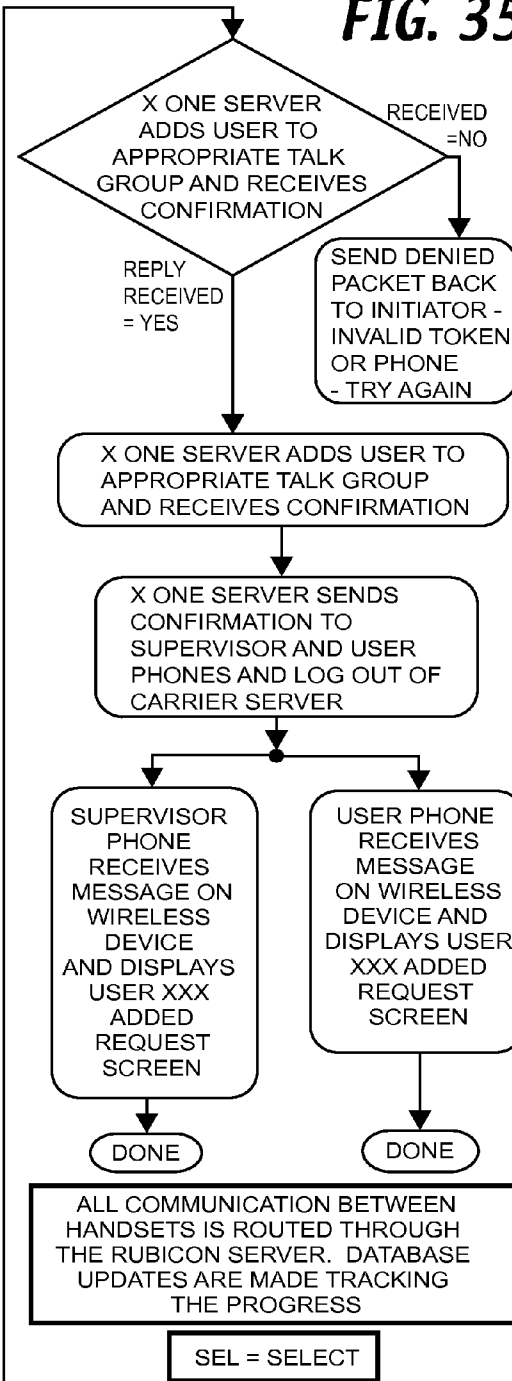
**SEQUENCE FROM SUPERVISOR TO ADD USER**



**SEQUENCE FROM SUPERVISOR TO EDIT USER**



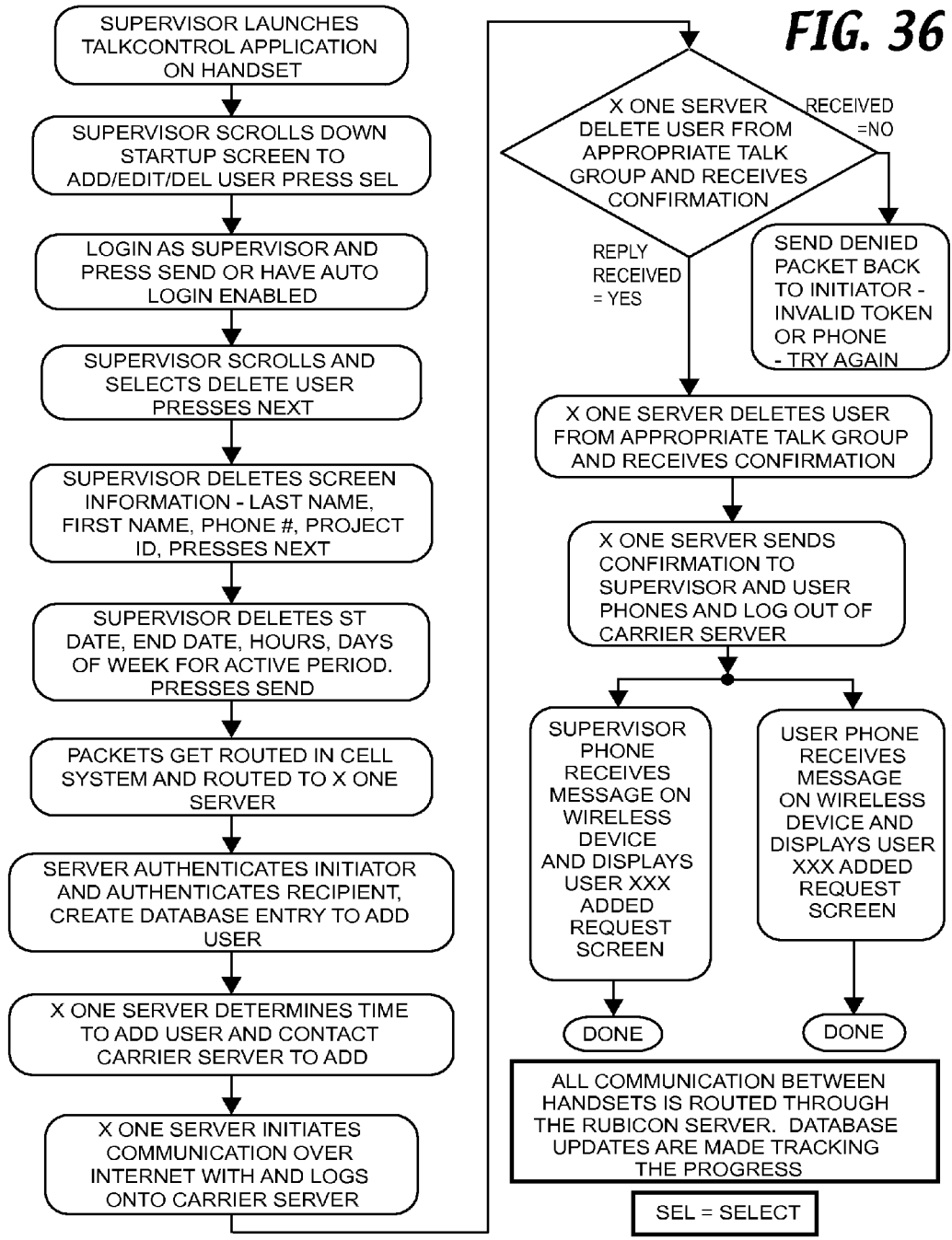
**FIG. 35**

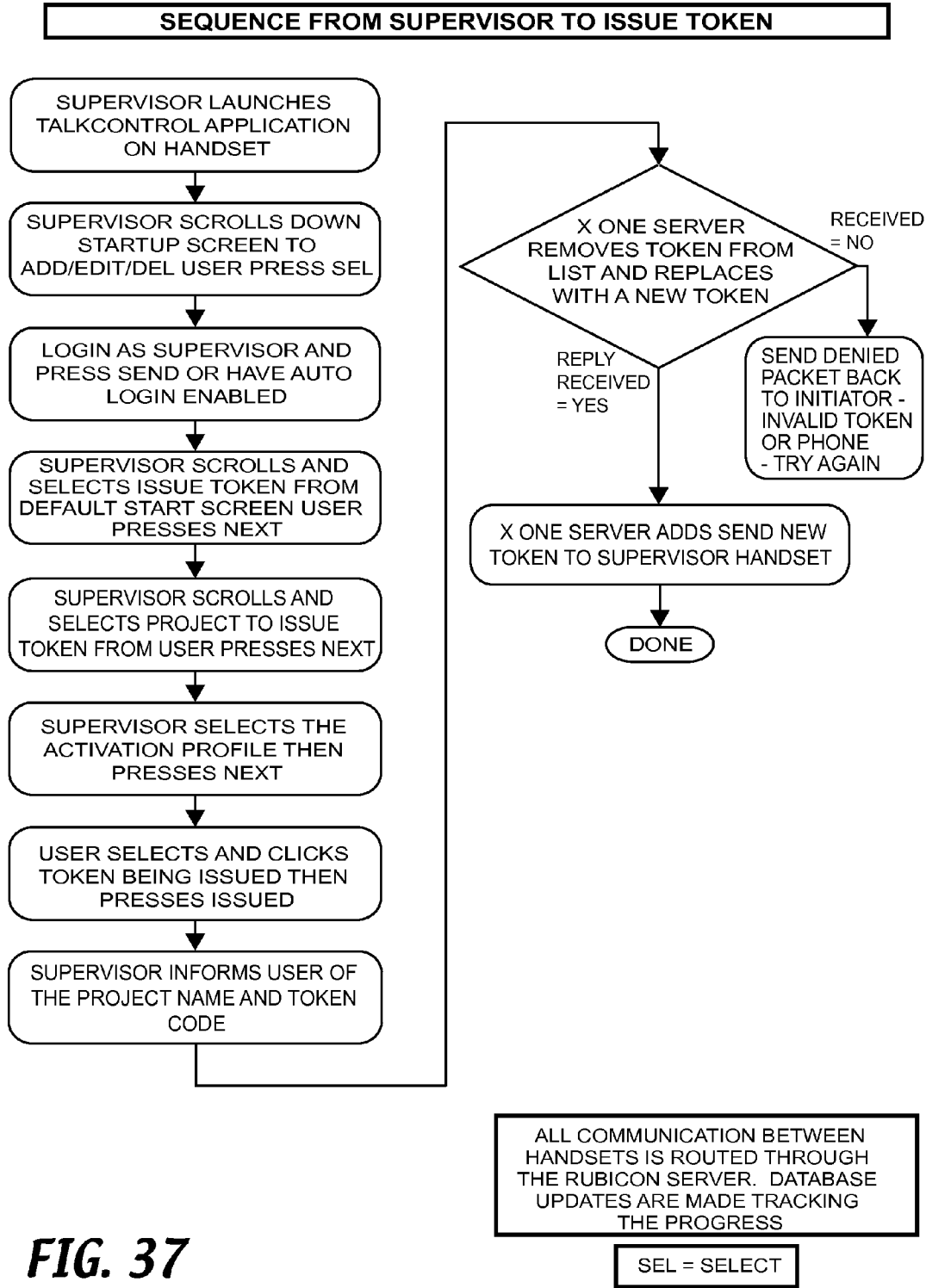


ALL COMMUNICATION BETWEEN HANDSETS IS ROUTED THROUGH THE RUBICON SERVER. DATABASE UPDATES ARE MADE TRACKING THE PROGRESS

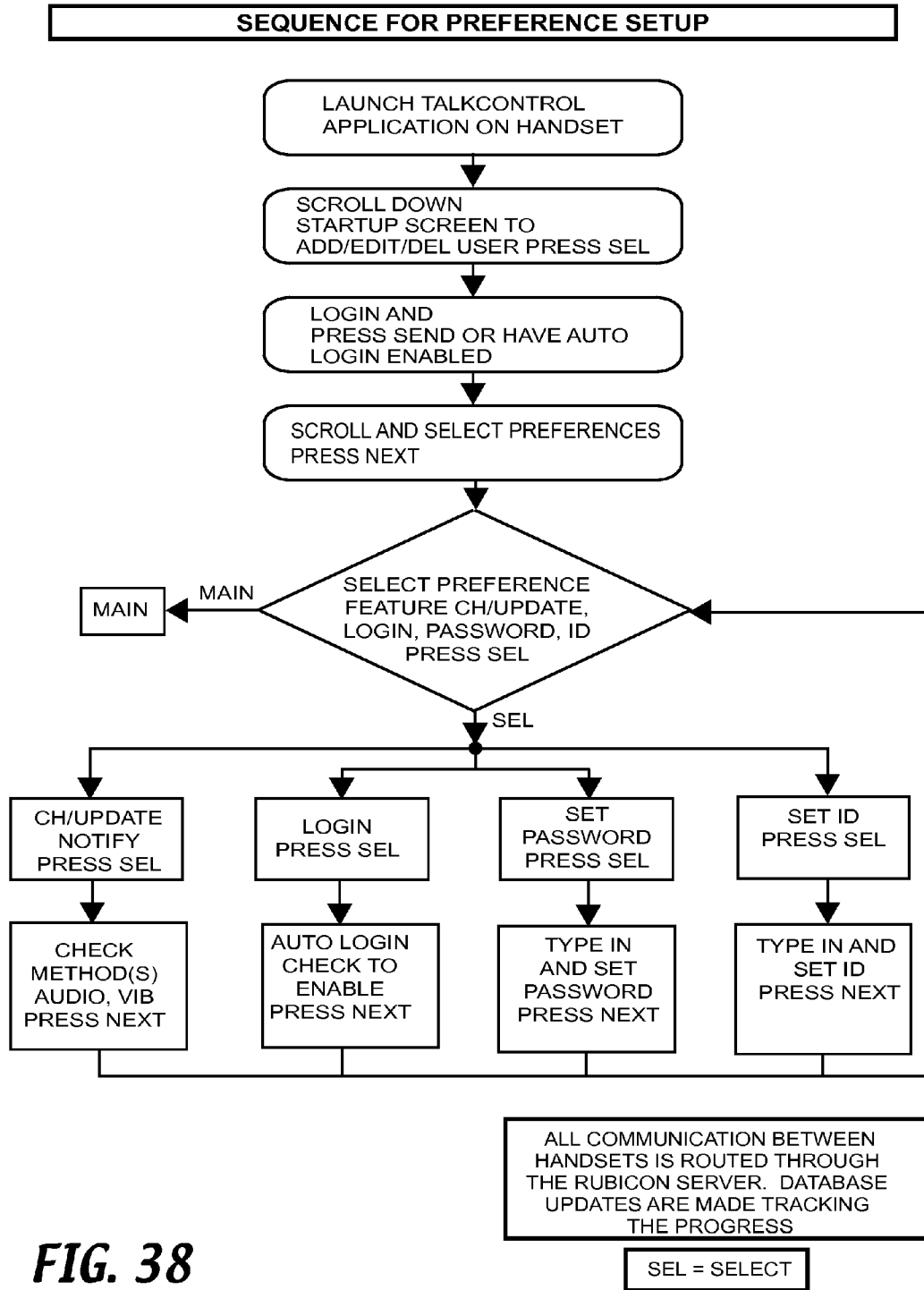
SEL = SELECT

**SEQUENCE FROM SUPERVISOR TO DELETE USER**

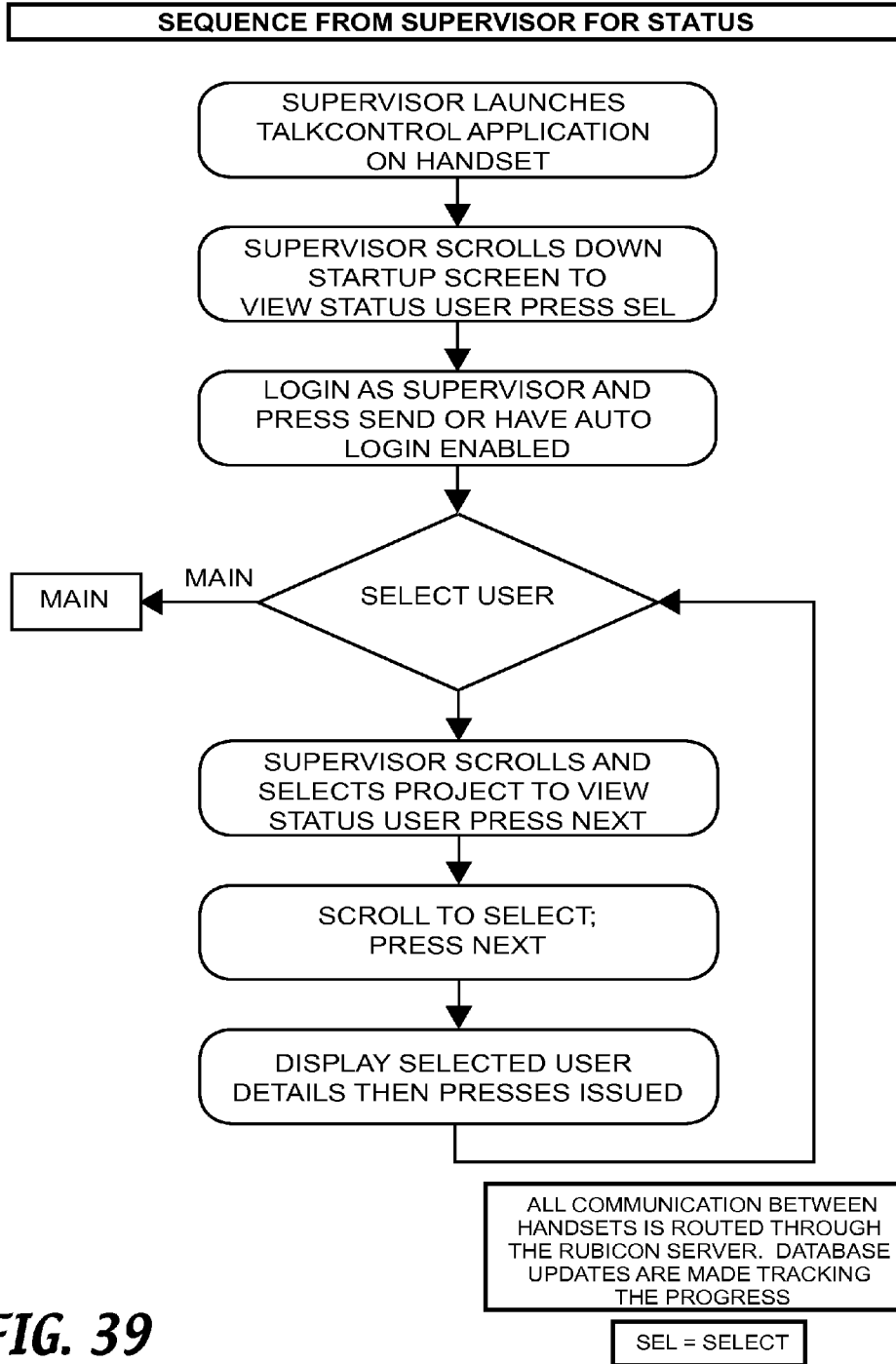




**FIG. 37**

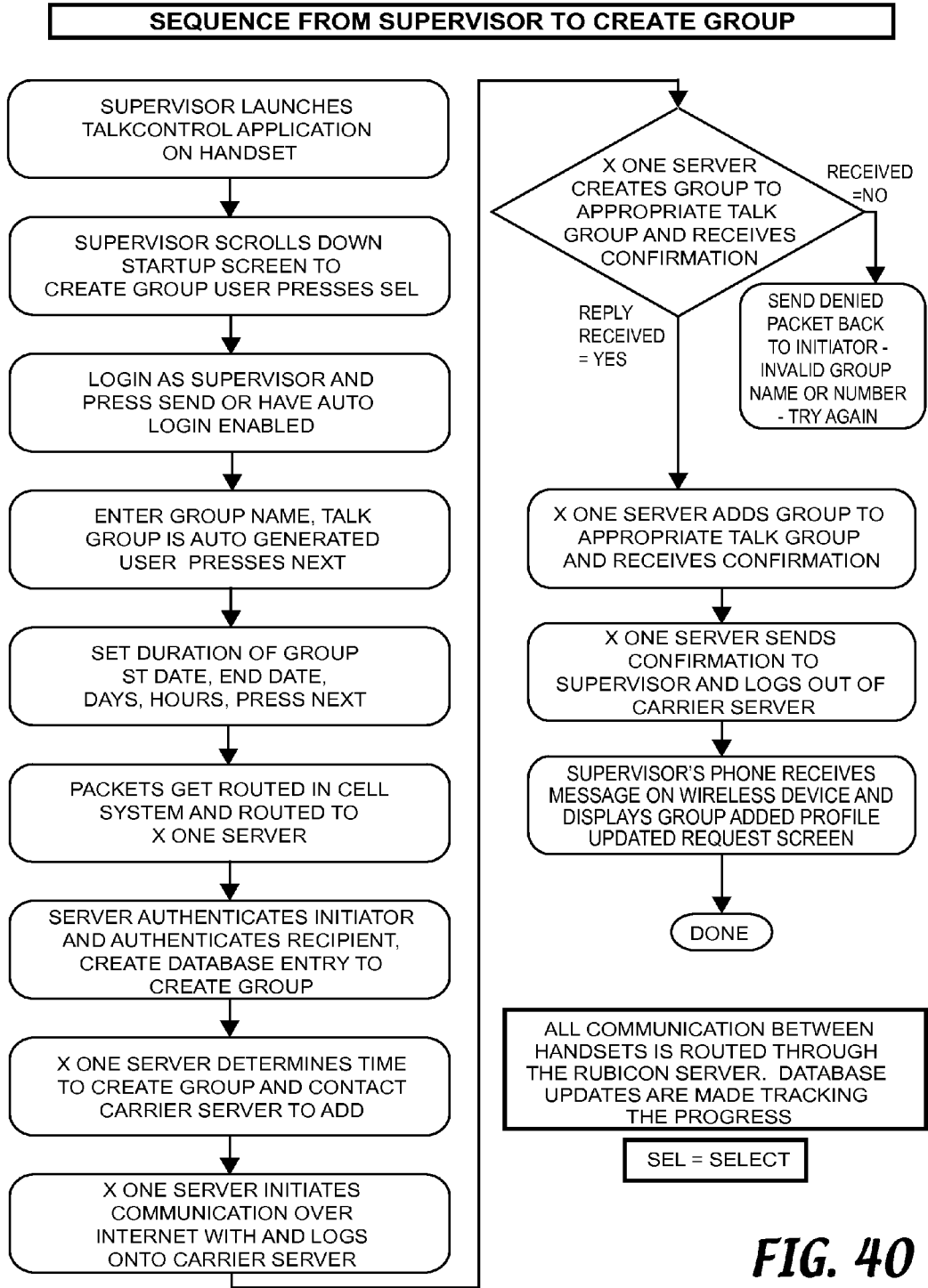


**FIG. 38**



**FIG. 39**





**FIG. 40**

**APPARATUS AND METHOD FOR  
OBTAINING CONTENT ON A CELLULAR  
WIRELESS DEVICE BASED ON PROXIMITY  
TO OTHER WIRELESS DEVICES**

CLAIM OF PRIORITY

This application is a continuation of U.S. patent application Ser. No. 14/139,695, filed Dec. 23, 2013, which is a continuation of U.S. patent application Ser. No. 13/889,132, filed Jun. 17, 2013 (now issued as U.S. Pat. No. 8,798,593), which is a continuation of U.S. patent application Ser. No. 12/075,408, filed Mar. 11, 2008 (now issued as U.S. Pat. No. 8,538,458), which is a continuation of U.S. patent application Ser. No. 11/099,362, filed Apr. 4, 2005 (now issued as U.S. Pat. No. 7,353,034). Priority is hereby claimed under 35 U.S.C. §120 or 365(c) to each aforementioned application, and each such application is incorporated herein by reference.

FIELD OF USE AND BACKGROUND OF THE  
INVENTION

The cellular market in 2003 was around 150-160 million devices in the US and the number is growing at over 10% per year at least. Europe already has 320 million cell phone users, and the global market is over 1.4 billion devices.

Cell phone carriers are looking for opportunities to increase both revenue and profits by providing new services. For example, recently cell phones have been provided with browsers to allow surfing the internet from the phone. One of the needs businesses, families and individuals have is the need to know where their employees, children and friends are. No two way position information sharing technology currently exists as far as the applicant is aware.

The one way location sharing prior art includes On Star and the Mercedes Benz TeleAid services where, via GPS receivers and cellular phone capability built into a car, an aid center can track cars all over the world and speak with the occupants and sense when the cars airbags have deployed. Other commercial services allow parents to track the locations of their children in a one way location sharing manner. None of these services allow the occupants of the car to know where the aid center is or allows the children to know where their parents are.

Another need is for a system for use by motorists, hikers, pilots and boatmen to allow them to be able to contact rescuers and know the location of the rescuers as they come to the aid of the stranded person and to allow the rescuers to know the location of the victims they are trying to rescue. The need requires that cell phones have the capability to be reconfigured in the field to add an "instant buddy" to the list of people with whom location information is shared. The prior art kid tracking systems could not be reconfigured in the field to add new individuals with whom location information was to be shared.

DIFFERENCES OVER KID TRACKING PRIOR  
ART

In the prior art, one could buy phones that were set up at the manufacturer to enable parents to locate their children. One such service allows up to eight phones to be used and allows parents to monitor the locations of their kids. But these services do not allow the kids see the locations of their parents because the service is not set up to share location information between phones. In other words, it is a one way service with the kid's locations being sent to the parents phones for display

but not vice versa. Further, there is no mechanism to add groups and members of groups, and there is no mechanism to set up "instant buddies" as that term is used below (temporary location sharing between phones on an ask and accept basis which automatically expires after a configurable interval terminates). The kid locator phones are set up at the factory and nothing can be changed in the field by the users and they are always on and cannot be disabled.

It is useful to be able to share locations among multiple cell phones which have GPS locator ability. Such an ability would be useful for people in groups who have made plans to meet at specific locations at specific times. When one person is late, the others in the group would be able to ascertain the tardy person's location. To alleviate privacy concerns, it would be useful to be able to turn off location sharing or to program location sharing so that it turns itself on automatically at some date and time and turns itself off at some other programmable date and time. It would also be useful to have a map display on cell phones which are picture enabled and to plot the locations on the map of persons in a group who have their location sharing capability turned on.

SUMMARY OF THE INVENTION

The invention contemplates 2.5 GHz and 3 GHz Java enabled, web enabled (or similar) cell phones and Personal Digital Assistants or other web enabled wireless products with global positioning system (GPS) receivers and sufficiently large liquid crystal displays for the preferred embodiment. The phones must be web enabled to be able to send and receive TCP/IP or other protocol packets over the internet to the Buddy Watch server.

In some embodiments where push-to-talk enablement is implemented, GPS receivers are not necessary in the cell phones but they must be web enabled to be able to send and receive TCP/IP or other packets over the internet to the Buddy Watch server.

These phones and other wireless devices are programmed with software (programmed at the factory or downloaded from the assignee of the present invention) to have the user interface and functionality described herein to allow mutual tracking and optional position mapping displays of members of groups and of instant buddies coming to the rescue of stranded motorists, hikers, pilots and boatmen. These phones work with a Buddy Watch™ server coupled to the internet. The server is not limited to any specific language or technology nor is it limited to any specific wired or wireless solution or any particular transmission physical layer or protocol.

The teachings of the invention do not require development of new cell phone or PDA technology nor do they require development of new cellular communication infrastructure. The functionality implemented by the software of the invention utilizes existing platforms and infrastructure. In the preferred embodiment, the software of the invention is developed to JAVA specifications.

In its primary mode, the process of the invention only allows exchanging and mapping of position data with persons on a Buddy List™ programmed into a Buddy Watch™ (synonym for Buddy Tracker™) device (defined as any of the devices mentioned anywhere in the specification when programmed to operate in Buddy Watch mode or coupled to another device operating in Buddy Watch mode). The user must allow others on his Buddy Lists to "see" his location (location sharing may be turned off), and the user must request to see the location of others on his Buddy Lists to be able to have their positions reported and/or mapped. Position information exchanged via radio transmission on the cellular



infrastructure is encrypted so that outsiders cannot see or use location information that is transmitted. A simple menu structure allows easy setup and management of Buddy Watch application programs. The keypad of the phone or PDA is used to enter information into the Buddy Watch enabled device. Online help is available to setup and use the Buddy Tracker application program(s).

The teachings of the invention can also be integrated into other products and services such as autos with GPS based navigation systems. This would be done by expanding the navigation system to have a cellular transceiver capable of sending and receiving digital data including position data to the Buddy Tracker server. It could also be done by expanding the GPS navigation system product to have a USB or other interface port to couple the system to a cell phone or PDA of the type described above. This interface would allow the GPS navigation system to receive position data from the wireless digital data transceiver and map the position data on the GPS navigation system display of the auto. Handheld GPS navigation devices can also be expanded by integrating a cell phone therein or providing a port to interface to a cell phone to exchange position information with the Buddy Tracker server.

In a system employing the teachings of the invention, the users can change things on the fly in the field such as: adding groups and members; adding instant buddies, changing the size of the area in which their buddies can be tracked, enabling or disabling the location information sharing function without disabling the phone, etc.

Some of the benefits of the Buddy Tracker technology are that it allows businesses to easily identify which service persons are closest to the next job and to let personnel in the field know the positions of their co-workers and to share their location with their co-workers. Parents can keep track of where their kids are. Friends can keep track of where their buddies are and share their position with their buddies. Location information will be shared only so long as the phone is on and in an area where the device can receive a GPS signal and send the phone's coordinates out on the cellular network (and the location sharing capability is enabled).

Further, the cellular carriers do not have to invest in engineering or infrastructure to offer the Buddy Watch functionality. The software that implements the Buddy Watch functionality can be downloaded from the web or installed at the point of sale of a cell phone or PDA. Use and sale of an application that makes use of the on-board GPS capability of cell phones and PDAs built to comply with the E911 requirement allows the carriers to recoup some of the costs imposed upon them by the E911 requirement.

Enhancements to cellular phones in recent years such as the addition of cameras and web browsers have lost track of one of the basic reasons for cell phones in the first place—people want to communicate with and know where other people are. This is applicable to parental monitoring and increasing the efficiency of business and increasing the effectiveness of law enforcement. The Buddy Watch system also functions to decrease the load on the 911 system since not every situation requires the help of 911 authorities.

#### BRIEF DESCRIPTION OF THE DRAWINGS

FIG. 1 is a screen shot of a typical opening screen which would be displayed on a cellphone with the BuddyTracker™ software enabled.

FIG. 2A shows a block diagram of the Buddy Watch system.

FIG. 2B illustrates a matrix or web of supervisory relationships and Buddy Lists.

FIG. 2C is a diagram of the start-up screen.

FIG. 2D shows the Mapit page.

FIG. 2E shows additions options for manual refresh, etc. which can be reached by scrolling down the Mapit page below the list of active users.

FIG. 2F is a screen of active users.

FIG. 3 represents a display in the user interface which shows individuals on the phone's Buddy List as well as a group of buddies which has been given the name Tennis Team.

FIG. 4 is a user interface display showing the result when the tennis team Buddy List entry is selected and the information that is displayed when one of the members of the tennis team is selected for display of location information.

FIG. 5 is a user interface display showing a map rendering with the location of a selected member of the tennis teach group displayed thereon.

FIG. 6 is a user interface display showing a map rendering with the location history of a selected member of the tennis team rendered thereon.

FIG. 7 is a screen shot of a display in a typical system employing the invention showing positions and status of members of a selected group.

FIG. 8 is a screen display showing what is displayed when Dean is selected and the Mapit command in box 48 is given by double clicking on the box or by any other means.

FIG. 9 is a screen shot of an instant buddy display after an instant buddy relationship has been set up.

FIG. 10 is a screen shot of a typical display in a system employing the teachings of the invention to establish an instant buddy ID in box 70, and give the instant buddy a caller ID in box 72 (the instant buddy's caller ID or phone number is used by default).

FIG. 11 is a screen shot of the display which appears on at least the instant buddy's phone after a stranded motorist, pilot or hiker has contacted 911 and entered a caller ID and carrier for a proposed instant buddy.

FIG. 12 is a block diagram of a typical prior art cellular system infrastructure in which the method and apparatus of the invention work in a peer-to-peer embodiment.

FIG. 13, comprised of FIGS. 13A and 13B, is a flowchart of the method of exchanging GPS position data among cell phones of a watch list.

FIG. 14, comprised of FIGS. 14A, 14B and 14C, is a flowchart of processing of an embodiment that implements several modes of operation.

FIG. 15 is a flowchart of the process of establishing an Instant Buddy Relationship.

FIG. 16 is a block diagram of a typical cellular system coupled by a gateway and a Wide Area Network such as the internet to a Buddy Watch server to provide the infrastructure of the invention.

FIGS. 17A and B are a flowchart of the preferred Instant Buddy Setup process.

FIGS. 18 and 19 are diagrams of some of the user interface display screens involved in the Instant Buddy Setup process.

FIGS. 20A and B are a flowchart of the process of enabling the personal bread crumbs mode and how it works.

FIG. 21 is a flowchart of another embodiment of a process to establish and use the personal bread crumbs mode.

FIG. 22 is a flowchart of the preferred embodiment for the instant buddy setup process.

FIG. 23 is a flowchart of another embodiment of a process to receive buddy location update requests and process them.

FIG. 24 is a diagram of the default start screen and some of the other user interface screens that the user can navigate to from the start screen.

FIG. 25 is a help screen showing how navigation to a view new alarms screen can be accomplished.

FIG. 26 shows the tree structure of a plurality of other screens which can be used to add target locations, annotate the target locations with text, voice or photo notes, add a text message, give commands to take a picture or find a picture file, record a voice message to be appended to the target, request position updates for all active buddies, map the positions of all active buddies or select particular buddies for mapping or requesting a position update.

FIG. 27 shows a number of screens which can be displayed to map the position of a selected user with history and give information about the user as well as send short text messages, record and send voice messages, photos, Instant Messenger links, target positions, etc.

FIGS. 28A and 28B show user interface screens created by Buddy Tracker software to create settings such as bread crumbs on or off, security codes for personal bread crumbs tracking and verification that a user is OK, set checkup timeout intervals, establish phone numbers and email addresses of other users to call in case of emergency in personal bread crumbs mode, add, change or delete group names, set the Mapit screen radius, refresh rate and update setting, refresh time, delta position change for refresh.

FIG. 29 shows the user interface screens to create a new buddy and showing the communication paths and accept protocol to do this.

FIG. 30 is a diagram of the user interface screens for defining, deleting and using map rooms for closed proximity groups, open proximity groups, etc. For closed proximity group map rooms, listed users can set their preferences to automatically enter or be alerted that they are in the Zone and manually decide to enter.

FIG. 31 is a block diagram of the system for TalkControl to simplify cell phone walkie-talkie operations.

FIG. 32 is a flow diagram of a process a user of a walkie-talkie enabled phone can initiate to join a talk group to enable subsequent walkie-talkie operations.

FIG. 33 is a flowchart of the process the Rubicon server carries out to automatically delete a user.

FIG. 34 is a flowchart of the process the Rubicon server carries out to allow a supervisor to add a user.

FIG. 35 is a flowchart of the process for a supervisor to edit a user in a talk group.

FIG. 36 is a flowchart of a process for a supervisor to delete a user from a talk group.

FIG. 37 is a flowchart of a process for a supervisor to issue a token.

FIG. 38 is a flowchart for the process of setting up preferences.

FIG. 39 is a flowchart of the process to allow a supervisor to request status.

FIG. 40 is a process flowchart of the process for a supervisor to create a group.

#### DETAILED DESCRIPTION OF THE PREFERRED AND ALTERNATIVE EMBODIMENTS

FIG. 1 is a screen shot of a typical opening screen which would be displayed on a cellphone with the Buddy Tracker™ software enabled on the phone. FIG. 2A is a block diagram of the Buddy Watch system. A Buddy Watch or Rubicon server communicates with wireless devices 2 through 6 via the internet 9 and wireless carrier systems 7 and 8. In the claims, the

Buddy Tracker software is called the GPS position data sharing software application and it is resident on each of wireless devices 2 through 6. Generally, communication between the handsets and the Rubicon (Buddy Watch) server occurs as follows. Each handset communicates data packets through its local cellular carrier network via TCP/IP compliant data packets encapsulated in cell system packets. The carrier network tower receives the packets and strips off the cellular encapsulation and forwards the TCP/IP packet to an appropriate gateway connected to the internet 9. Routers in the internet route the packet to its destination, generally the Buddy Watch server 1. The receiving server validates the content of the IP packet to authenticate the sender as a registered Rubicon user and to verify that the sending phone EIN matches the phone EIN stored in the server. Once authenticated, the packet content is processed by the server. A response to the request in the packet is prepared using information from a database maintained by the Rubicon server and any associated map needed for the response is requested from a map server. The complete response is compiled, including any data needed to render a map on the recipient wireless device display and packetized into a TCP/IP packet and sent back to the originator of the request via internet routers and carrier gateways that couple the wireless carrier systems to the internet. The gateway of the carrier identifies the correct tower for the cell in which the recipient's phone is currently resident and the packet is encapsulated in a cell system packet and forwarded to the appropriate tower where it is transmitted wirelessly to the cell phone or other wireless device of the recipient. The wireless device then recovers the data in the TCP/IP packet and the port address in the TCP/IP packet header causes the packet to be routed to the Buddy Watch software where it is processed.

FIG. 2C is a diagram of the start-up screen. On startup, each handset starts its GPS sampler and the Buddy Watch application program. If Main is pressed, the user is taken to the Nextel default page (or whatever other carrier is being used). If Mapit is selected, the user is taken to the Mapit page shown in FIG. 2D. FIG. 2D shows the Mapit page where the positions of active users within the radius set up in the preferences of the center point XXX within radius YYY is shown. Scrolling down the Mapit page below the map is the list of active users including those outside the radius. FIG. 2E shows additional options for manual refresh, etc. which can be reached by scrolling down the Mapit page below the list of active users. FIG. 2F is a screen of active users. Color is used to highlight items. Scrolling to a user and pressing OK gives two options: re-centering the map on the user and displaying details of that user.

The Buddy Tracker software creates the displays such as that shown in FIG. 1 and other user interface displayed discussed elsewhere herein. FIG. 24 is a diagram of the default start screen and some of the other user interface screens that the user can navigate to from the start screen. This is a help/emergency screen 15 which has a next command 19 which can be selected to take the user to the 911 screen 17 which can be used to take the user to a screen 21 wherein the user can select the type of help requested. FIG. 25 is the help screen and shows how navigation to view a new alarms screen can be accomplished. FIG. 26 shows the tree structure of a plurality of other screens which can be used to add target locations, annotate the target locations with text, voice or photo notes, add a text message, give commands to take a picture or find a picture file, record a voice message to be appended to the target, request position updates for all active buddies, map the positions of all active buddies or select particular buddies for mapping or requesting a position update. FIG. 27 shows a

number of screens which can be displayed to map the position of a selected user with history and give information about the user as well as send short text messages, record and send voice messages, photos, Instant Messenger links, target positions, etc. FIGS. 28A and 28B show user interface screens created by Buddy Tracker software to create settings such as turning bread crumbs on or off, security codes for personal bread crumbs tracking and verification that a user is OK, set checkup timeout intervals, establish phone numbers and email addresses of other users to call in case of emergency in personal bread crumbs mode, add, change or delete group names, set the Mapit screen radius, refresh rate and update setting, refresh time, delta position change for refresh. FIG. 29 shows the user interface screens to create a new buddy and shows the communication paths and accept protocol to do this. FIG. 29, is discussed more below, and is a representation of the screens and protocols to initiate and accept an instant buddy relationship. FIG. 30 is a diagram of the user interface screens for defining, deleting and using map rooms for closed proximity groups, open proximity groups, etc. For closed proximity group map rooms, listed users can set their preferences to automatically enter or be alerted that they are in the Zone and manually decide to enter. For Open Proximity Group Map Rooms, anyone can join by opting in from their phone or from a sponsor's website. Upon entry, they can view and be viewed by all other members in the map room. Proximity rooms are useful to find and be found by friends attending an event.

In FIG. 1, area 10 discloses that the Buddy Tracker location sharing application software is active and is sharing the location of the phone with other members of a designated group. Area 12 indicates that parental status is active which means that the employer of the employee carrying the phone or the parent of the kid carrying the phone can see the location of the employee or kid if the phone is on. When parental status is active, the supervisory function cannot be turned off or evaded. This supervisory location sharing can be hierarchical such that an employer can see the location of all its employees, and each of the employees can be set up as supervisor of their children such that the employees can see the locations of their children, but the employer of each employee cannot see the locations of the children of each employee. The supervisory relationships can be set up to define a matrix or web of Buddy List and supervisory relationships, such as is illustrated in FIG. 2B.

In FIG. 2B, phone A has phones C and D on its Buddy List and is set up as the supervisor of those two phones. Phone B has phones A, G, F and E on its Buddy List and is set up as the supervisor of those phones. Phone H has phones E, J and I on its Buddy List and is set up to supervise those. Phone K has phone I on its Buddy List and is set up to supervise phone I.

Each of the phones in FIGS. 2A and B is coupled to the cellular carrier infrastructure in a conventional manner and can send phone calls or short text messages or email messages to any other phone including the cell phones represented by lettered circles in FIG. 2B. FIG. 12 is a block diagram of a typical prior art cellular system infrastructure in which the teachings of the invention in a peer-to-peer embodiment can be practiced. An area of the country is divided into several cells represented by circles such as 93 and 95. Inside each cell is a transceiver tower, represented by blocks 94 and 96 which carries out time division multiple access or code division multiple access digital radio communications with cell phones in its cell. The cell phones or PDAs are represented by autos 98 and 100. Data recovered from the cell phone transmissions is transmitted to a central switching system 102 by

data paths such as 104 and 106. The central switching system 102 is coupled to a public service telephone network 108.

Transmissions from one cell phone to another take place via the towers such as 94 and 96 and the central switching system 102. For example, suppose cell phone 98 wants to send its GPS location data to cell phone 100 and cell phone 100 wants to send its GPS location data to cell phone 98. The system of the invention uses some communication protocol such as XML, modified short text messages or other methods to send GPS location information to all cell phones on a Watch list. XML is a slimmed down version of SGML and enables Web authors to create their own tags so that they can more accurately capture the structure of their data. Because this structure can be read by SML-compliant browsers, the information encoded in these tags can be made available to programs such as Java applets or it can be displayed by formatting the XML tags with a style sheet.

In the preferred embodiment, the wireless devices in a group which has location tracking turned on periodically send their GPS position data to all the other members in the group. The process for each wireless device to send its position data to any other wireless device in the group is as shown in FIGS. 13A and 13B. Basically, FIG. 13 is a flow chart of the process of two or more cell phones exchanging encrypted GPS position data. FIG. 23, discussed below, is a flowchart of another embodiment of a process to receive and process Buddy location update requests. The process of FIG. 13 starts at step 110 with a request for a position update. In the preferred embodiment, this happens when a user of a Buddy Tracker phone uses his phone to make a request for a location update. In other embodiments, location updates can be requested automatically and periodically by the Buddy Tracker software on a device that is reporting its position. In other embodiments, a position update can be automatically generated by a device which is reporting its position to other members of a group whenever the position of the device has changed from its last reported position by a programmable amount. The requested position update may be sent to everybody on a selected Buddy List or just a single person's wireless device. In some embodiments, the position update is sent to some subset of persons on a selected Buddy List. Step 112 represents the process of looking up the addresses for all people on the selected Buddy List, a watch list, or just a selected individual or a subset of individuals from a watch list, as the case may be. Some embodiments may be limited to position updates on entire Buddy Lists.

Step 114 represents the process of reading the GPS position data from the built in GPS receiver of the phone (or the GPS receiver of the navigation system) and encrypting the position data.

In step 116, cell phone 98 puts its encrypted GPS location data into a message according to the chosen communication protocol (assume short text message—SMS for short) and addresses the message packets to the one or more phones of the selected persons with which position information is to be shared.

In step 118, the SMS message packets are transmitted to tower 94 using whatever physical layer protocol the cellular system uses such as TDMA or CDMA. The header of the SMS packets contains data indicating the payload data is to be sent to the Buddy Watch software of a particular cell phone and not to the inbox of the phone's SMS software. The payload data of these packets is the encrypted GPS position data. The physical layer protocol typically involves the following steps. First, the packets are disassembled into groups of bits of some predetermined size called codewords the size of which depends upon the particular configuration of the forward

error correction software. The codewords are then interleaved to help defeat burst errors. Each codeword can then be encoded with error detection and correction bits such as by using Reed Solomon encoding. The codewords are then broken down into groups of bits called constellation points. The number of bits in each group depends upon the type of modulation scheme in use. In some embodiments, the groups of bits are then further encoded in a Trellis encoder.

The encrypted GPS position data packets would be addressed such that they would be routed in the cellular system to all the other wireless devices using the Buddy Tracker software which requested a position update. This is done by routing the packets to the cell transceivers in the cells in which the wireless devices which require updates are currently registered, as represented by step 120. For example, if cell phone 100 in FIG. 12 is on the Watch list or is being automatically updated or has requested a position update manually, it will have transmitted a packet to transceiver 96 indicating it needs a position update and, when the wireless device entered cell 95, it will have exchanged packets with transceiver 96 to achieve synchronization with transceiver 96 and to register in cell 95. Each wireless device that is registered in a cell will have done this, and the transceivers in each cell will communicate with the central switching system 102 to indicate which wireless devices are registered in their cells. Therefore, the routers in central switching system 102 will know which wireless devices are registered in each cell and will know which wireless devices are to receive position updates. Step 120 represents the process of receiving the signals from each wireless device that are modulated with constellation points that contain the data of packets that contain GPS positions, recovering the data from the constellation points and doing error detection and correction and recovering the GPS position data packets. These packets are then routed to the central switching system which uses the destination addresses in the packets and its routing tables to route them to the transceivers in whatever cell or cells the wireless devices that require position updates are registered. There, the packets are disassembled, encoded with error correction and detection data, and assembled into symbols or constellation points in whatever type modulation (QAM, QPSK, etc.) is being used and transmitted to the wireless device. This happens for every wireless device on a watch list or which has requested a position update.

At each wireless device which receives the signals modulated with the constellation points bearing the GPS position data, the data of each packet is recovered and the packet is reassembled, as symbolized by step 122. The header data of the packet (the port number in the case of TCP/IP packets) causes the wireless device to pass the packet to the Buddy Tracker software which is monitoring a particular port, step 124. When a packet is passed to that port (or just the payload data thereof), the payload data is decrypted and the position data recovered, step 126. Step 126 also represents the process of reading the header data of the incoming packets and determining which other member of a buddy group sent the position update so that the position information for the proper member of the Buddy Group is displayed. The position data is then used to display the position of the other party in the group who sent the packet, and, if the user gives the "Mapit" command, the position data will be converted to a waypoint on a displayed map so as to graphically display the position of the wireless device which sent the packet.

Step 128 represents the process of the device which received the position update encrypting its own GPS position into short message or email packets addressed to the other members of a Buddy Watch group or to a single other wireless

device. These packets are then sent to all the other wireless devices by the same process described in steps 116, 118, 120, 122 and 124 of FIGS. 13A and 13B, as represented by step 130.

FIG. 23 is a flowchart of another embodiment of a process to receive buddy location update requests and process them. Step 220 represents requesting a buddy location update. Addresses of all persons on the buddy list or just a selected buddy are located in step 222. Message packets are generated in 224 addressed to the selected Buddy List or individuals, and encrypted position data is put in them. A request is sent—226, and these packets get routed to the Rubicon server—228. The initiator and recipient are authenticated—230, and the packets are forwarded to the recipients via the cell system. The cell system forwards the packets to whatever cell each recipient is in—232. The packet arrives and causes a GPS position request to be made in each wireless device—234. The device captures its current GPS position, and encrypts it and packetizes the GPS position in the payload portion of a packet addressed to the Rubicon server with information as to the requestor in some embodiments. The packet is then sent with a timestamp to the Rubicon server for forwarding to the requesting Buddy—238 and 240. The Rubicon server authenticates the initiator and the recipient and forwards the packet to the initiator via the cell system—242. The cell system forwards the packet to the cell where the initiator recipient is located—244. The initiators cell phone receives the packet, and recovers the timestamp—246, and reads the packet header and port number of the GPS information and uses the port number to route the packet to the Buddy Tracker software—248. The Buddy Tracker application program on the initiator's cell phone receives and decrypts the GPS information from the packet, displays the position of the Buddy, and uses information in the header to determine which other Buddies sent position updates—250. The wireless device of the initiator responds to the position update of each Buddy by sending a reply packet with the encrypted position of the initiator—252. Each requested Buddy device updates the Rubicon server and the wireless device of the requesting buddy with its position—254.

#### Out of Coverage Update Response

In some embodiments, when a wireless device requests an update from another wireless device, and the other wireless device is out of cellular coverage, a timeout occurs. When a timeout occurs without receiving a position update, the wireless device expecting the update changes its display to yellow or some other color for the wireless device which is out of coverage. The Buddy Watch system only works when the phone is on and in a cellular coverage area.

#### Buddy Watch Modes

FIG. 14, comprised of FIGS. 14A, 14B and 14C is a flowchart of processing of an embodiment that implements the several modes described below. The steps that are numbered with like numbers to steps in FIG. 13 represent the same functionality.

1) Disable: The Buddy Watch application can be disabled by the user. When disabled, the wireless device does not share its GPS position data with any other wireless device so no other buddy can see your position. There is an exception for the parental monitoring function. When parental monitoring is turned on, as symbolized by line 111 in FIG. 14A, the wireless device always shares its GPS position and cannot be disabled. The disable functionality is represented by test 113 in FIG. 14A which determines when a position update is requested whether the Buddy Watch function has been turned off. If so, processing proceeds to test 115 which determines if parental monitoring is turned on. If not, processing proceeds

11

back to step 110 along line 117 and GPS position sharing does not happen. If the Buddy Watch function has not been disabled, processing proceeds to step 112 to look up the addresses of the wireless devices to which the position update is to be sent. When the Buddy Watch application is disabled

and it has been operating and parental monitoring is not turned on, a final position update is sent to those wireless devices on the current Watch List (the wireless devices which are active and monitoring each other's positions).

2. Enable: This is the normal mode of operation. Buddies can be added or deleted from the Watch List at any time. Any wireless device that is operating and on the Watch List can find the location of any other device on the Watch List by issuing a position update request. If a buddy is removed from a Buddy List, he or she is not able to receive position updates. Multiple lists can be joined to form a group.

3. Supervisor—Parental/Corporate Code: In this mode, as long as the wireless device of the worker or child is on, the supervisor will be able to monitor position by GPS position updates. The worker or child will not be able to disable the Buddy Watch feature nor remove the parent or supervisor from the Watch List. Only the supervisor or parent will have the necessary password to remove himself from a Buddy List or watch list.

4. Buddy Lists: This is the normal mode of operation. Buddies can be added or deleted from a list at any time. If a buddy is off a Buddy List, he cannot receive position updates from any other wireless device on the list. Multiple Buddy Lists can be joined into a group and entire groups may be enabled and disabled. Workgroup lists are lists of buddies which need to be aware of the location of their coworkers during working hours but not after. Buddy Lists or Buddy Groups are a means to have a single icon, folder or some similar graphic user interface (GUI) mechanism to represent a list of people and enables single commands to turn on or turn off tracking of a group of people. If a folder is used for each Buddy Group, a drop down list showing the specific names and locations of each person on the list can be displayed when the folder or icon representing the group is selected. If an icon is used, the Buddies would be grouped in and shown on the phone display. Groups receive a color on the GUI and the members of the group are connected by a translucent shaped outline encompassing all the points representing positions on the Mapit display. If the group is spread too far apart to be shown on a single Mapit display, then the shaped outline for the group is not shown and on the specific color coded Buddy positions that can be shown are shown. If the Mapit display is zoomed out, the translucent group outline returns when all members of the group can be shown on a single screen. Buddies that are in multiple groups are colored a non group color or the color of any of the displayed groups. If groups overlay and when Buddies that are in two active groups are shown, the translucent outline shall overlap as needed, and only cover Buddies that exist in both lists.

5. Instant Buddies: Instant Buddies can be created when a call is placed between two cell phones, phone enabled PDAs or other wireless Buddy Watch enabled devices. FIG. 15 is a flowchart of the process of establishing an Instant Buddy Relationship. The first step is 132 where the wireless device places or receives a call from a Buddy Watch enabled wireless device to or from another Buddy Watch enabled wireless device. The two users such as a stranded motorist and a tow truck driver discuss the situation and decide to establish an Instant Buddy relationship. After the call is established, and the two agree to allow it, the two wireless device users can click on the Instant Buddy menu choice in the Buddy Watch

12

menu, as symbolized by step 134. The wireless devices then each display an Instant Buddy Setup screen like that shown in FIG. 11 (step 136) and fill in the appropriate data (fields 84, 88 and 86) in step 138. Both users then indicate their acceptance (field 92 or deny the relationship (field 90), or in some embodiments, only the recipient of the call needs to accept or deny the relationship. Once the Instant Buddy relationship is accepted, the two wireless devices start exchanging position data (step 140). After 24 hours, or some other time set in the Instant Buddy preference menu (timeout checked in step 142), Instant Buddies are discarded (step 144). The Instant Buddy preference menu allows the time period for the Instant Buddy relationship to be set to something other than the default value of 24 hours.

15 Preferred Instant Buddy Setup Process

FIG. 16 is a block diagram of a typical cellular system coupled by a gateway and a Wide Area Network such as the internet to a Buddy Watch server to provide the infrastructure of the invention. The cellular system shown in FIG. 16 is typical and has the same structure and operation as the cellular system of FIG. 12. What is new is the connection between the central switching system and a Buddy Watch server 146 through gateway 148. The purpose of this will be made clear in the following discussion of the preferred Instant Buddy setup process.

25 Buddy Watch Server Functions

The Buddy Watch server's main function is to serve maps to the cell phones registered in the Buddy Watch system and implement GPS position data exchanges between itself and the phones on a buddy list to enable members of a buddy list to view the locations of other members of the list. In some embodiments, the Buddy Watch server also downloads application software as needed to phones registered in the system as the phones send packets to the Buddy Watch server indicating a particular command has been given which requires an application program on the phone which is not present.

In the preferred embodiment, the Buddy Watch server runs all the application programs on the server and just sends pages to be displayed on the phone to solicit the user to enter data needed to implement a function.

If the phones had as much memory as the Personal Digital Assistants, the application programs could be loaded and run on the phones themselves.

Other functions of the Buddy Watch server are: setup of user profiles, billing and database access and maintenance. Purchase/Payment Activate Deactivate Key

The functions of the Buddy Watch server will be made clear in discussions which follow. But one of its functions will be to manage activate and deactivate codes. The Buddy Watch application will be a service which a cellular carrier offers on a subscription basis. When a subscriber buys a Buddy Watch enabled phone, he will be issued an activation code and the Buddy Watch server will also be given the activation code. This activation code will be kept in active status as long as the subscriber has paid for the service. Subsequent communications of packet data between the Buddy Watch server and the phone such as downstream position updates of positions of buddies on a Buddy List, receipt of phone position for use in updating other buddies on a Buddy List, etc. will only be enabled as long as the activation code is in active status. When the subscriber stops paying for the service, the activation code will be changed to a deactivation code status, and subsequent communication between the phone and the Buddy Watch server will be impossible. The Buddy Watch server implements this functionality by checking the activation code status each time before communication with a phone is carried out.

The Buddy Watch application is downloaded via the internet for subscribers who do not already have it on their phones. The customer receives an activate code to key into the phone, or an activation application on the Buddy Watch server receives confirmation of the purchase and automatically sends the activate code to the phone/Personal Digital Assistant and receives back a confirmation. Each month, payment for the service is required. Failure to make the payment results in an application receiving a request to deactivate the Buddy Watch application on the phone/PDA. A deactivate code is sent and a response is received back confirming the phone application has been deactivated. Further attempts to use the application are met with a simple display indicating the service subscription has expired.

The protocol to activate and deactivate the Buddy Watch application is secure in the preferred embodiment.

FIGS. 17A and B are a flowchart of one embodiment for an Instant Buddy Setup process. FIGS. 18 and 19 are diagrams of some of the user interface display screens involved in the Instant Buddy Setup process. All three figures will be referred to in the following discussion. In the preferred embodiment, the Instant Buddy relationship is set up in the following manner.

1) An initiator selects the Instant Buddy menu choice options in step 150. This is done by selecting menu option 151 of screen 153 in FIG. 18. This causes a transition to display screen 155 on the initiator's device where the user selects menu option 157. This causes a transition to screen 159 on FIG. 19 which is the Instant Buddy setup screen. This screen shows the initiator's phone number, Instant Buddy ID and Screen ID in auto filled fields 161, 163 and 165, respectively (step 152). There is also a timeout field 167 which the initiator can set to some time if the default time of midnight is not acceptable (step 154). After filling in the timeout value, the Initiator clicks Next in field 169.

2) Instant Buddy request packets are generated and sent to the cell transceiver of whatever cell the wireless device of the initiator is registered. These packets contain data which identifies the initiator and the recipient (proposed Instant Buddy) and are addressed to the IP address of the Buddy Watch server 146 in FIG. 16. The packets are recovered by the cell transceiver, sent to the central switching system 102 and routed from there to gateway 148 where they are routed over wide area network 147 to the Buddy Watch server (step 156).

3) Buddy Watch server authenticates the initiator and the recipient from data in the packet as a Buddy Watch subscribers. If either is not a Buddy Watch subscriber, the server blocks the transaction by not forwarding the packets to the recipient. Assuming both are subscribers, the server forwards the Instant Buddy request packets to the recipient's wireless device and these packets get routed in the cell system (step 160) via the gateway, central switching system and cell transceiver of the cell in which the recipient's wireless device is registered.

4) The proposed Instant Buddy's wireless device receives the packets and displays an Instant Buddy Request screen (step 164) like that shown at 171 in FIG. 19 (step 162). This screen shows the phone number, Instant Buddy ID and Screen ID of the Initiator so the recipient knows who has requested the Instant Buddy relationship. The recipient can either accept or deny the relationship using commands displayed at 173 and 175.

5) If the Instant Buddy relationship is accepted (step 166), processing proceeds to step 168 where an accepted packet is sent back to the initiator's wireless device. If the Instant Buddy relationship is denied, step 170 sends a denied packet back to the Initiator device and the process is over (step 172)

save for a display on the Initiator device that the Instant Buddy relationship has been denied.

6) When the accepted packet arrives at the Initiator device, the device shows an Instant Buddy accepted screen as shown at 177 in FIG. 19 (step 174). This screen shows the phone number, Instant Buddy ID and Screen ID of the recipient and provides commands to accept or cancel the relationship at fields 179 and 181.

7) If the Initiator accepts the Instant Buddy relationship (step 176), step 178 occurs where an accepted packet is sent back to the Recipient through the Buddy Watch server.

8) The Buddy Watch server records the existence of the new Instant Buddy relationship (step 180), and both wireless devices start sending their GPS position data in packets addressed to the Buddy Watch server. The Buddy Watch server stores the position data from each wireless device and forwards the packets to the other device for updating of their displays. In the preferred embodiment, the Buddy Watch server pulls an appropriate map from the MapQuest server 149 in FIG. 16 based upon the GPS position data of the Initiator and sends that map and the GPS position data in packets addressed to the Recipient. The Buddy Watch server then pulls an appropriate map from the MapQuest server based upon the Recipient's position, and sends that map and the Recipient's GPS position to the Initiator. Each wireless device then displays the position of the other Instant Buddy on the map provided by the Buddy Watch server.

An alternative Instant Buddy setup process is described next:

- 1) A call from one wireless device to another is initiated;
- 2) After agreeing to establish an Instant Buddy relationship, the initiator clicks on the Instant Buddy menu option;
- 3) This causes an Instant Buddy Setup screen to be shown on the initiator's device which has a first field which is auto-filled with the initiator's phone number, a second field which is auto-filled with an Instant Buddy ID, and a third field which is auto-filled with a Screen ID for the Instant Buddy (this screen ID is a three digit number which will be displayed with the position of the Instant Buddy and is shorter than the Instant Buddy ID);
- 4) The initiator fills in a timeout period for the Instant Buddy relationship or accepts the default value of midnight and clicks a Next command;
- 5) The recipient's wireless device receives the instant buddy request and displays an Instant Buddy Request screen that shows the initiator's phone number, Instant Buddy ID and Screen ID and displays an accept or deny command;
- 6) The recipient either accepts or denies the Instant Buddy relationship;
- 7) If the recipient accepts the Instant Buddy relationship, this fact is communicated to the initiator's wireless device which then displays a screen which displays the recipient's phone number and the recipient's Instant Buddy ID and his or her Screen ID and displays an accept or deny command which the initiator can click on;
- 8) If the initiator selects the accept command, both wireless devices start exchanging GPS position data, but they do not if the initiator decides to deny the Instant Buddy relationship.

FIG. 22 is a flowchart of the preferred embodiment for the instant buddy setup process. The initiator selects the instant buddy setup process—250, and enters the phone of the proposed new instant buddy—252. The initiator fills in timeout period—254, and instant buddy packets get routed to the Rubicon (Buddy Watch) server through the cell system—256. Rubicon server authenticates the initiator and recipient and forwards packets to cell system—258. The cell system routes packets to the cell where the proposed new instant buddy

15

is—260, and the proposed instant buddy receives a message on her wireless device and displays the instant buddy request screen—262. The instant buddy sees the initiator buddy ID, screen ID and, optionally, his phone number—264, and accepts or denies the relationship—266, 270, 272. If 5 accepted, a packet is sent back to the initiator's wireless device—268, which causes the initiator's device to show an Instant Buddy accept screen with the recipient's phone number, buddy ID and screen ID which the initiator must OK to establish the relationship—274. Steps 276, 278 and 280 10 handle the acceptance or rejection. In 282, if accepted, the Rubicon server records the new instant buddy relationship and both wireless devices start sharing location information with the Rubicon (X One) server where it is stored and forwarded to the other Instant Buddy. In 284, the initiator's device shows the Instant Buddy Accept screen. Steps 286, 288 verify the phone is collecting GPS data using the GPS sampler program.

#### User Interface Displays for Buddy Lists

FIG. 3 represents a display in the user interface which shows individuals on the phone's Buddy List as well as a group of buddies which has been given the name Tennis Team. In all the user interface screen shots in the figures of this patent application, a cross hatched area indicates an active status and is typically colored green on the phone display. For example, each cross hatched buddy in column 14 indicates that that buddy's location sharing is active and his position can be seen if the user clicks on that buddy using whatever navigation or pointing mechanism that is built into the cell phone user interface.

The Buddy Tracker software also has the ability to set up instant buddies with, for example, tow truck drivers. Display area 16 shows an instant buddy entry for an instant buddy named Inst01. For example, the user's car breaks down. The user calls a towing service, and finds out the tow truck driver has a cell phone with Buddy Tracker on it. The user dials the tow truck driver's cell phone and requests to be an instant buddy of the tow truck driver's phone. His phone is then set up as an instant buddy on the user's phone. After both phones are set up as instant buddies, each phone shows the location of the other phone on its moving map. This allows the tow truck driver to find the user tow truck customer and the user customer to know where the tow truck driver is.

FIG. 4 shows another user interface display that results from selecting the tennis team entry 18 on the Buddy List of FIG. 4 and then clicking on the Tracie entry. When the Tracie entry is clicked, the information in column 20 appears showing her full name, position, the time of her last fix, her distance from the user and her speed. A green status (cross hatched) means a buddy has his phone on with location sharing turned on and the phone is within range. A yellow status for a buddy (stippled) means the buddy was active and had his location sharing turned on, but contact with him has been lost for one reason or another. A darker green status (double cross hatched), means the buddy is active and has his location sharing turned on but he is out of the immediate area that can easily be shown on the phone's map display. For example, suppose most of the tennis team group are in the Northern California area, but one member of the group is in Los Angeles. If the member in Los Angeles has his phone turned on with location sharing on, his entry in the tennis team list will be shown as dark green meaning his position cannot be mapped.

The Mapit function shown at 22 in FIG. 4 is a function that can be invoked to map the location of Tracie Saka on the phone's display. If Tracie is within range, and the Mapit function is clicked, a display such as the one shown in FIG. 5

16

is rendered on the phone's display showing the general area and showing Tracie's position at 24 with a text box 26 superimposed on the map with Tracie's name rendered therein.

FIG. 6 is a user interface display showing a map rendered with the location history of a selected member of the tennis team rendered thereon. This display is rendered when the Mapit with History function 28 in FIG. 4 is selected. This display shows the path Tracie took to get to her current location by way of waypoints 30, 31, 32 and 33. In some embodiments, when a user wishes to record a waypoint for their current position, a command can be given that causes the current position of the phone to be reported and saved as a waypoint on the Buddy Watch server 146 in FIG. 16.

In other embodiments, a particular position such as the phones current position or a position selected by moving crosshairs on a map display on a phone can be sent as a meeting place to all buddies on a Buddy List. When such a command is given and a Buddy List is selected, the position of the meeting place and the designated Buddy List is put into packets addressed to the Buddy Watch server 146 and transmitted thereto where the information is stored. The meeting position is then packetized in packets addressed to all the buddies of the designated Buddy List, and those packets are addressed to the phones of the buddies on the designated Buddy List and sent thereto.

Referring to FIG. 7, there is shown a display of a screen showing positions and status of members of a selected group. In this example, Tracie and Karen's positions are known and their name boxes in the left column are displayed in some color such as green indicating they are within cellular coverage and their positions are known. On the other hand, Dean's name box is shown in some other distinctive color such as yellow (represented by single cross hatch) to indicate contact with Dean has been lost. This happens when a user travels outside cellular coverage. Because Dean's name box is currently selected by the cursor, the settings column has the last known information about Dean also displayed in the distinctive color and represented by a single cross hatch. These boxes show Dean's last known position fix time (box 34), his full name (box 36), his last known distance (box 38), and his last known direction, latitude, longitude and speed (boxes 40, 42, 44 and 46, respectively).

FIG. 8 is a screen display showing what is displayed when Dean is selected and the Mapit command in box 48 is given by double clicking on the box or by any other means. When this Mapit command is given, Dean's last known position is displayed with a circle of a distinctive color (such as red), as illustrated at 50.

#### Instant Buddy Display with Mapit Position Mapping

An instant buddy relationship also allows the location of the motorist, lost or injured hiker or other user to appear on the tow truck or ambulance driver's cell phone Mapit display.

FIG. 9 is an instant buddy display showing the instant buddy position. This display can be selected after an instant buddy relationship has been set up. This display shows the ID of the instant buddy in box 52, the time of the last position fix in box 54, the distance to the instant buddy in box 56. The direction to the instant buddy, latitude and longitude and speed of the instant buddy are shown in boxes 58, 60, 62 and 64, respectively. If the user selects the Mapit command in box 66 or the Mapit with history command in box 68, the phone display will change to a display like that shown in FIG. 8 or FIG. 6, respectively, with the current position of the instant buddy shown and the prior positions shown if the history option is selected.

Alternative Instant Buddy Setup Process: To set up an instant buddy relationship, the phone is given a command to

display an instant buddy setup screen like that shown in FIG. 10. The display of FIG. 10 is used to establish an instant buddy ID in box 70, give the instant buddy a caller ID in box 72 (the instant buddy's caller ID or phone number is used by default). Box 74 is used to establish a timeout period at the end of which the instant buddy relationship is automatically terminated. The timeout period can be set to any interval in some embodiments, or to some selected interval from a drop down menu. Box 76 is used to establish the carrier the instant buddy is using. A cancel command is shown at 78 and a request command is shown at 80.

To start the instant buddy relationship, the request command is issued after the other boxes are filled in. Typically, a stranded motorist or hiker will call a tow truck or 911 and get the caller ID and carrier of the tow truck driver or rescuer. The stranded motorist or hiker will then enter this information in boxes 72 and 76. Box 70 shows an instant buddy ID which is automatically assigned by the system. After entering the information, the request command shown at 80 is selected. The screen of the rescuer's phone will then change to the display shown in FIG. 11. The information the requester filled in on the FIG. 10 screen will appear in boxes 82, 84, 86 and 88 on the stranded motorist or hiker's phone as well as on the instant buddy's phone (the tow truck or 911 rescuer). Commands for Denied and Accepted will also appear at 90 and 92 of the instant buddy's phone. If the instant buddy desires to accept the instant buddy relationship, he or she selects the accept command, and the tracking of the two instant buddies' positions will begin. Upon acceptance of the instant buddy relationship, each instant buddy's phone displays changes to the display shown in FIG. 9 from which the Mapit or Mapit with history command can be issued.

#### Corporate Supervision Setup Via Passcode

Corporations that wish to monitor the locations of their employees can use the system of the invention by using a corporate passcode. In this mode of operations, corporate employees are set up as a group with their supervisor as one member of the group. Each employee in the group can have his own buddies but he cannot delete the supervisor from the group. Only the supervisor can delete himself from the group of each employee's phone since only the supervisor has the passcode to change the group's members to delete himself. In one embodiment, the location information sharing is unidirectional from employees to supervisor but each employee can see the location of other employees on their phones but not the location of the supervisor. In this embodiment, the location sharing can be configured to be on only during working hours Monday to Friday. In other embodiments, the employees can see the locations of the supervisor as well as the locations of the other employees.

#### Timed Updates

The teachings of the invention contemplate doing position updates periodically at configurable intervals as well as a configuration option to do periodic updates as well as an update every x miles if a buddy in a group being monitored moves more than x miles between periodic updates. In some embodiments, the velocity at which a Buddy is moving or the amount of distance since the last update a Buddy has moved controls the frequency of the updates. Timed updates are handy for parents to monitor the positions of their children to make sure they do not move more than X miles from their home base. Position updates can be requested by a member of a Buddy List for position updates from the Buddy Watch server. The server receives positions reports from all the Buddy Watch phones registered with it and stores them and knows the Buddy Lists for each phone. When a request for a position update is received, positions of all the buddies on

Buddy Lists of which that phone is a part will be transmitted as packets addressed to all the phones on all the Buddy Lists of which the requester is a part. In alternative embodiments, the position updates will be sent for all members of all Buddy Lists of which the requesting phone is a part, but will only be sent to the requesting phone to avoid excess network traffic. In other alternative embodiments, the requesting phone can designate a particular member of a particular Buddy List and request an update only for the position of the designated buddy. The position update will be sent only to the requesting phone.

#### Follow Me Mode

In some applications such as construction sites with large construction crews and one supervisor, it is useful for everybody working on the job to be able to find the supervisor but the supervisor does not care where anybody else is. In embodiments with this capability, the supervisor turns on the Follow Me mode, typically making a menu selection. This causes the supervisor's position to be reported to the Buddy Watch server on a regular basis in packets that have information in their headers or elsewhere which indicate they are Follow Me packets and which designates to which Buddy List this information is pertinent. The Buddy Watch server takes these position updates and packetizes them into packets addressed to each of the phones on the designated Buddy List and sends those packets to the Buddy List phones. Position updates from the phones on the Buddy List are not sent to the supervisor phone or any of the other phones on the Buddy List.

This Follow Me mode can also be done in a blind code mode. This means that the supervisor does not need to list everyone on his buddy list. This is an "open channel" mode. Any "follower" who wants to track the position of the supervisor only needs to list the supervisor's name and phone number on a buddy list of the "follower" phone. The supervisor enters a blind code in the Follow Me mode, and this code is published to all phones that have Buddy Watch software. This blind code entry and publication allows any follower to enter the blind code in a buddy list on the follower phone and thereafter to receive the supervisor's position reports. This entry of the blind code will give any follower the ability to receive position reports from the supervisor's phone, and the supervisor will not have to approve each buddy individually. This can be a great convenience since on some job sites, there may be hundreds or thousands of workers. The follower phone sends a packet to the Buddy Watch server telling it that the follower phone is in the Follow Me mode for the particular supervisor. This causes the Buddy Watch server to send position reports it receives from the supervisor phone to the follower phone, but the server does not send position reports from the follower phone to the supervisor phone. The follower phone does not send position reports to the Buddy Watch server when in the Follow Me mode. Disabling, removing or changing the blind code, stops Follow Me mode.

#### Buddies Only Mode

The Buddies only mode differs from the All On Follow Me mode and the Blind Code Buddies modes in that position reports are only received from Buddies on a specifically named Buddy List with specifically named Buddies. No blind code Buddies or Instant Buddy position reports can be received in this mode.

#### Waypoint Store Mode

This mode is useful for parents to monitor the travels of their children. In this mode, the child's phone periodically reports the child's position, and the parent can have the position reports sent to his phone (or computer in some embodiments). In some embodiments, position alert data can be



19

configured to send an alarm signal to a parent if a child's position gets too close to a specified location or too far from the home location or some other location.

#### Request Update

This mode allows a specific user to request an update on the position of a specific Buddy. The requesting phone sends a request packet to the Buddy Watch server identifying itself and requesting a position update on a specified Buddy. The Buddy phone need not do anything other than do its normal operation of sending position updates to the Buddy Watch server. The update request causes the Buddy Watch server to provide a two-way update so that the requesting phone's location is sent by the Buddy Watch server to the Buddy phone and the Buddy phone's location is sent by the Buddy Watch server to the requesting phone. If the requester is part of a group, then the Buddy phone's location is sent to all phones in the group.

#### Timed Update

In this mode, periodic updates from the phone of a person such as a child or other person being cared for can be periodically sent to a list of parental or other supervisor destinations such as the parent's cell phone or email address. The sender phone may also be configured to send its location periodically to all others on a list. Updates on position can be every 15 minutes or some other configurable interval. In addition, each supervisory user can request an update and the updates will be sent to every phone on the supervisory list. If a phone on the list is not available, the update will indicate that no update is available, change the display to yellow and the status to unavailable but keep displaying the last way point.

#### Personal Bread Crumbs

This is an emergency feature which allows tracking down children or elderly people who are no longer responding to inquiries sent to their phone. This mode is useful for children who do not want to be watched but want a safety line to their friends and family in case something happens. A user who wishes to use this feature sets up their profile such that the Buddy Watch server checks in with them via their Buddy Watch enabled phone on a daily basis to determine if all is OK. The user must enter their secret code to confirm that all is OK. The phone prompts them to enter this code, and a certain number of prompts can be ignored before the system raises any alarms.

FIGS. 20A and B are a flowchart of one embodiment of the process of enabling the personal bread crumbs mode and how it works. Step 200 represents the process of enabling this mode. Typically, this is done by the user in selecting a menu command, but in some embodiments, it may be permanently configured to be on by the phone manufacturer. When this mode is enabled, the phone stores waypoints of the position of the holder of the phone periodically (step 202). The phone does not send the waypoints to anybody, but it does send data or a message to the Buddy Watch server that the personal bread crumbs feature has been enabled (step 204), so the Buddy Watch server starts a timer (step 206). The purpose of starting this timer is to establish intervals at the end of which an "Are you OK?" message will be sent to the phone which is in Personal Bread Crumbs™ mode.

Step 208 represents the process of monitoring the timer for a timeout event. This may take the form of a hardware or software interrupt. When a timeout occurs, the Buddy Watch server sends an inquiry to the phone inquiring if the user is OK (step 210). The phone then displays the "Are you OK?" message, and the user either enters his or her secret code to say they are OK or does not. If the user does not respond, processing proceeds back to step 206 to start the timer again as

20

the user may simply be busy, have their phone off, be asleep, etc. However, after a configurable number of attempts to establish contact with no response, step 216 will conclude that the user may be in trouble and need rescue. In that case, processing is vectored by step 216 to step 218. In step 218, the phone is commanded by the Buddy Watch server to send distress messages out to predetermined phone numbers (five in the preferred embodiment) and/or email addresses. The voice mail message may indicate to check email for details. The email contains a content of a position report file that contains all the waypoints since the last OK was received. If there are no stored waypoints, at least one set of stored waypoints previously recorded are sent. The waypoints all provide latitude, longitude, date and time of recording.

The personal bread crumbs profile includes:

- 1) a list of emails to which messages should be sent;
- 2) a list of phone numbers to which the prerecorded voicemails are to be sent;
- 3) frequency of OK confirmation the user needs to agree to (default is daily at noon);
- 4) the text of an email to describe the emergency situation to readers which should include the mobile phone number, home phone number, work phone number, home address and other pertinent information; and
- 5) whether or not auto attachment of waypoints to emails is to be carried out.

In an alternative embodiment, step 218 represents the Buddy Watch server itself sending out the distress messages. In some embodiments, the distress messages are prerecorded voicemail messages which indicate the user may be in trouble and giving instructions to the recipient how to retrieve the position reports from the Buddy Watch server. Step 218 also represents the process of the phone sending its GPS position waypoints to the Buddy Watch server. In some embodiments, the prerecorded voicemails are sent to pre-determined phone numbers and the predetermined emails are sent to predetermined email addresses and include the GPS position reports in the text of the message. The email messages at least will include the personal breadcrumb position reports. These messages indicate to the recipients that there may be trouble and that they should start looking for the person who owns the phone.

FIG. 21 is a flowchart of another embodiment of a process to establish and use personal bread crumbs mode. In step 201, the user enables the bread crumbs mode, and in step 203 the mobile phone contacts the Buddy Watch server (also called the Rubicon server herein) and informs it that personal bread crumbs mode is on. GPS sample data is collected (205) and the server is contacted to start the "Are you OK" timeout interval (207). Timeout causes the phone to display an "Are you OK" message (209). Steps 211 and 213 handle the situation where the user does not enter a secret code and retries. Step 215 represents the Rubicon server response if the user does not respond to the "Are you OK" message properly and timely, said response involving sending whatever distress messages are set up in the preferences file. GPS location samples and timestamps are included in the distress messages (217) and the messages are sent to the users listed in the preferences file (219).

#### Relational Database Compatibility

The Buddy Watch server is configured and programmed to be compatible with business applications where the customer may desire to find individuals based upon their capabilities, certifications or the equipment they are carrying. By making the Buddy Watch fields of the Buddy Watch database available for search and/or integration into other business databases, a company such as a service based organization can

determine which individuals have the proper certification to work on a specific problem and/or who have the appropriate tools and where those individuals are located relative to a site to which the company wishes them to be dispatched. The Buddy Watch server is programmed to provide information about the subscribers and their locations in a format which is compatible with the other business database structures of customers who are interested in having this data. Each position update received by the Buddy Watch server then is exported and automatically updates the customer database. This can be done over the Internet or over a dedicated local area or wide area network.

#### Radar Inclusion

The radar inclusion mode is a mode which allows police departments or fire departments or any other emergency response type organizations to instantly expand their buddy lists to predetermined lists of all available personnel. This is useful when it is necessary to know the whereabouts of persons to assist in an emergency situation or other situation. This feature may be used by police or other groups where the formation of a group may vary throughout the day. This feature can be used in conjunction with standard groups. How this feature differs is that a user does not need to be identified and only when the user comes within the "radar" range or radius does the user get included within the radar inclusion group.

City, County, State or Federal law enforcement or other agencies can offer two capabilities with radar inclusion. The first capability is to send an alert with a fixed target or to add a moving target to any individuals or groups without any input from the field officers. The target could be a suspect on the move. The target affords all the officers a better view of what is going on. The second capability allows the agency using the radar inclusion feature to "light up" the positions of other individuals or groups of individuals on a Mapit display so that one or more officers/firemen responding to an emergency can see the positions of possible reinforcements relative to their position. This is useful when groups that normally do not work together such as perhaps the fire and police need to work together. Details about each Buddy which is lit up on the Mapit display can be sent to any other Buddy in need thereof by a command to the Buddy Watch server issued by the controlling personnel of the agency.

In the instant messaging protocol packets transmitted from a phone to the Buddy Watch server, there is a field that can be left blank or a prefix can be put in. An agency using radar inclusion can put a code in this field and then all Buddy Watch phones/PDAs operating in radar inclusion mode are sent these packets and retain the Buddy whose information is in the packets in a group. This new group can be retained for a user programmable time up to 24 hours beyond the radar inclusion Buddy display disappearing.

The Buddy Watch server determines if a matching radar code is in range of a user and is not currently part of their active buddy list. If not they are added if the radar inclusion mode is active.

#### Split Groups

When a member of a group specified by a Buddy in that group for Mapit display is outside the radius set up in a Group Map Size configuration entry, then that member is split from the group and will not appear on the map of the group. However, that member which has been split from the group will have an entry in a distinctive color such as dark green on the list of active users in the group. Changing the Group Map Size configuration entry to a larger size may allow the split member to be displayed. If the location of the split member must be viewed but the Group Map Size is not to be changed,

clicking on the member of the group which has been split from the Buddy List will cause the Mapit display to change to the locale of the split member and display the member's location on the map so long as the split member's Buddy Watch status is active.

#### Power Off or Disable Buddy Tracker

When the phone is turned off or the Buddy Tracker application is disabled, a final transmission to the Buddy Watch server of the location of the Buddy is made. The Buddy Watch server distributes this location in packets addressed to all the members of the group of the Buddy who just went to inactive status.

#### Targets

The Buddy Tracker software allows targets to be designated to specify meeting points, sites of emergencies or service call locations. Law enforcement agencies can use this feature to silently redirect personnel to the site of a crime or emergency without broadcasting the location on the radio for persons using police scanners to hear. Each target can have a user defined label associated with it and a message, photo(s) or other document(s) can be attached to the target. All the data defining the target, any label associated therewith and any photos or other documents is packetized in packets identifying the data therein as target data or attachments to the target. These packets are received by the Buddy Watch server and re-packetized addressed to all members of a group or a radar inclusion group or specific Buddies.

A target can be specified by any member of a group or by a dispatcher of a law-enforcement or other agency. Targets can be specified using a web browser. The target is a forward looking waypoint. This can be useful if groups are to meet at a predefined location and the first to arrive may find this is either not the right location or for some reason the meeting point should be changed. The target can be moved, and then packets containing the data of the new target location are sent by the Buddy Watch server to all members of the group with an alert message indicating the target has moved. Targets can be moved simply by dragging and dropping the target to a new location on the display on the web browser which is logged into the Buddy Watch server and which has invoked the target specification command. Once the target has been initially set, moving it to a new location creates a waypoint history. Each target can have a description associated with it, and if the target has been moved, the history can be viewed.

#### Out of Coverage Operation

When devices are out of cellular coverage, some limited operations are still possible based on the device. For devices with a full GPS receiver, the user can set targets or force waypoints that are stored. Each device may differ based on the amount of available memory.

If a Buddy takes his phone into areas of intermittent coverage, it offers a means of some contact. Additionally, one may visit a site on a rural road or other location out of coverage. Setting a target or forcing a waypoint from a phone or desktop computer which is not located at the target provides the location, but does not provide any idea regarding what is at the location. A picture phone at the location can capture a picture of the location, and this picture be associated with the target to give other Buddies in the group some idea of what to expect when they get to a meeting point or target.

When a user wants to return to the site, the saved target can be recalled and sent to other Buddies in a group or individually designated so a return trip can be planned. This provides the ability to return to spots not located on roads or at intersections such as pastoral settings.

Local maps when out of coverage would not show up on the user's phone when the Mapit command is issued. This is

because the map pixels are sent from the Buddy Watch server to the phone after being retrieved from a mapping server such as Yahoo maps. When the phone is out of coverage, the map pixel packets cannot reach the phone and it cannot render a map. However, if the phone has a GPS receiver, it can store the point the user indicated he would like to capture, and, later when the phone is back in coverage, it can send the GPS location to the Buddy Watch server in a Mapit command packet, and get the map pixels back from the Buddy Watch server along with any attachments.

Phones with limited memory will decrease the frequency of position updates so as to not exceed the memory capacity. Attachments to Targets and Waypoints

Attachments such as photos can be appended to targets and waypoints even with travelling outside a coverage area. Once the phone is back in coverage, the attachment to a waypoint for example will be sent to the Buddy Watch server and can be distributed to other users. Documents created with phone apps or pictures captured by the phone's built in camera can be attached, and, if the phone has a USB port, pictures captured by a digital camera or camcorder can be imported and attached.

#### Encryption of Data

The Buddy Watch software application is disabled and encrypted when it is downloaded to prevent other unauthorized users from installing and using it. The Buddy Watch application program is decrypted and enabled when the access code is downloaded after a subscription is purchased since the decryption key is or is part of or is encoded into the access code.

#### Access Codes

Access codes to enable the Buddy Watch application are designed to incorporate the phone number or phone serial number as part of the encryption key so that the access code can only enable one phone. Large groups with many phones, can ask for and receive access codes that allow operation across a large number of phones.

Access codes are downloaded to the phone from the cell provider's server or emailed to the user when the user provides their name, phone number, phone serial number and a form of payment. The application may be downloaded to a MAC or PC, and then configured on the personal computer before being uploaded to the phone by a computer-to-phone USB connection.

#### Targets

A member of a buddy group can market a target on a Mapit display, and that target location can be shared to all the members of the group and show up on their Mapit displays so they all know where to meet. Marking targets is done using cursors on the Mapit display on the phone. The user then designates the buddy list to which the marked target is to be published. Packets are generated in the Buddy Watch application on the phone which include the GPS location, any name assigned to the target and the identification of the buddy list to which the location is to be published. These packets are sent to the Buddy Watch server which then extracts the data and packetizes it into packets addressed to all the phones on the designated buddy list. These packets are then sent to the buddies on the list and the location of the target is extracted and posted on a Mapit display.

#### User Waypoints

The users can mark particular waypoints as they travel using the Mapit displays on their phones, and pictures or memos can be attached to these waypoints. In one embodiment, this is done by sending a packet with the location marked by the user to the Buddy Watch server and in that packet giving an identifier or pointer that will be contained in

other packets which record the memo or photo to be attached to the waypoint. The Buddy Watch server then extracts the data from these packets and stores the user waypoint location with a pointer to the file in which the memo or photo is stored.

#### 5 SOS Support

Each user of Buddy Watch can define a profile of buddies to which an SOS alert is to be sent in the case of emergency. The SOS alert message includes location, time and phone number (caller ID) and a preset message for email or Instant Message service and a prerecorded voice message. This data is sent in packets addressed to the Buddy Watch server when the user gives a command to send the SOS message. The Buddy Watch server then receives the SOS message, determines who it is from, retrieves the SOS profile stored on the server for that user and generates packets for email and IM and sends them on the internet and generates packets containing the digitized voice message and addresses them to the phones listed in the SOS profile and sends those packets to the cellular system central switching system **102** in FIG. **16** via internet gateway **148**.

The SOS message protocol can be carried out by the Buddy Watch server either on demand from the user, or automatically in conjunction with any 911 call made from a phone which has a stored SOS profile. The SOS support configuration file contains data which defines which way the phone will act, and the buddies receiving the SOS messages will be aware of whether an 911 call was made or not. The buddies are actually in a better condition to help the caller since they can see the caller's position on their Mapit displays, and they may be closer to the caller and be able to act quicker than the 911 support personnel.

The preferred embodiment causes the SOS messages to be sent when the user dials **\*\*911\*\***. A **\*\*411\*\*** dialed call will send the SOS messages to only active buddies whose phones are registered in the system and on with Buddy Watch activated.

#### The User Interface Genus

All species within the genus of user interfaces according to the teachings of the invention will display buddy lists and a list of buddies on each buddy list when that buddy list is selected. All species will display the specific information about a buddy when a particular buddy is selected including at least their current location and the time of the fix. All species will display a command or icon or menu choice that can be invoked to allow a user to turn off location sharing. All species will display commands, icons or menu choices to add, delete or edit buddy lists, or to add or delete or edit buddies.

Some species within this genus will also display one or more of the following items of information about individual buddies: speed, last contact, altitude or direction. Some species within the genus will provide icons, menu choices, etc. which a user can invoke to allow the user to select a map display with the location of a buddy displayed thereon. Some species within the genus will allow a user to give a command to request historical fixes which trace a path to the buddy's current position. Some species within the genus will allow instant buddy relationships to be set up to allow location sharing between a person in trouble and a rescuer.

#### 60 The Server Genus

All servers programmed with Buddy Watch software will have functionality to:

1. either store map data for entire geographical areas that they serve or to obtain pertinent map data from another server such as a Mapquest™ server and pick the appropriate maplet that surrounds the positions of buddies to be displayed and serve the maplet data to Buddy Watch enabled phones;

25

2. pick the appropriate maplet for each buddy list or buddy based upon the center of gravity of the buddy positions of the buddies within the selected buddy list and exclude buddies which are out of the coverage area;
3. render buddy locations on maplets based upon GPS location data gathered from Buddy Watch applications running on GPS enabled cell phones and PDAs;
4. store user defined data that embodies each user's buddy lists and buddies and configuration data;
5. store at least some preference data that defines who can use the server, e.g. only those with a valid Buddy Watch user ID and password);
6. request and receive update and regularly scheduled GPS location data from users who have their Buddy Watch application turned on their phones or PDAs and to distribute location data and maplets to the phones and PDAs of the buddies on buddy lists who have their Buddy Watch capability turned on; and
7. turn Buddy Watch functionality on or off in terms of receiving location data from users who have indicated they want their Buddy Watch application turned off and turn off sharing location data of buddies who have turned off their Buddy Watch application.

Various species within this genus: can calculate the center of gravity of the best fit for the maximum number of buddies that are within the coverage of one maplet; determine the proper maplet size to send to the client phone or PDA based upon configuration data which defines the screen size of the device; send the same size maplet to all clients; allow each client to determine its own maplet size; send maplets with buddies color coded to show who is out of bounds and who is in lost contact status; implement a permissive buddy list wherein a person cannot be added to a buddy list until they consent; implement timed updates for GPS position and scheduled cutoff times for position sharing; store auxiliary information about each buddy such as phone numbers, etc.; offer the functionality to allow each user to specify the maplet size they receive or specify a maximum maplet size for a buddy list; offer the functionality to request updates whenever a programmable delta time or delta position difference over the last update occurs; offer a user preference to turn on or turn off GPS position updates; the ability to cross communicate with other carrier's cellular systems to send maplets to and receive location data from users on other systems; function to enable or disable the Buddy Watch application without disabling location sharing with parental or supervisor units; storing as a preference or configuration data SOS emails and voicemail messages which can be sent out to email addresses and/or phone numbers specified in a configuration data file on demand or automatically when a 911 call is made.

the Client Application Genus

The client Buddy Watch application and phone or PDA platform genus collectively provide the following functionality:

1. the programmed phone or PDA must be able to retrieve GPS position data directly or indirectly from a GPs receiver in the phone or PDA, and it should be able to wirelessly send the GPS position data to the Buddy Watch server either periodically or on demand from the server, but one or another, it must be able to exchange position information data with the server;
2. the phone or PDA must have a display large enough to display maplets and be able to download maplets from the Buddy Watch server;
3. it must have Java or similar software to exchange digital data with the Buddy Watch server using a wireless web application program;

26

4. it must be able to communicate with the phone's application programmatic interface and any application programmatic interface of the cell phone service provider to:

be able to receive maplets from the Buddy Watch server with location data rendered thereon and display the maplets;

send location data and receive downstream messages and requests from the Buddy Watch server.

- An important species with this genus will be able to request software needed to execute commands given by the user from the Buddy Watch server, receive a download of the software requested, install it into random access memory and execute it to carry out the requested command. In other species, the software Apparatus and Process are to simplify Push to Talk walkie-talkie operations in cell phones.

FIG. 31 is a block diagram of the system for TalkControl to simplify cell phone walkie-talkie operations. Block 300 is a location determination component which functions to determine user locations. This can be done in the cell phones or the Rubicon server and provides a generic solution to extract location from GPS, J2ME location API or bespoke development for extracting Cell ID. If done on the server, the GMLC based solution is used. Block 300 also does distance calculations, location format conversion etc. LDG can expose a LIF based interface to location based services when applicable. This provides location determination flexibility as needed.

SBC component 302 functions to do buddy group/list management, mapping techniques, refresh based upon time or delta movement, geo coding, reverse geo coding, routing, etc.

CMC block 304 functions to provide local content to location based services. The content can be local maps or commercial/enterprise specific content. Multiple parties like commercial content providers, government establishments or enterprises will provide the content. This CMC component will provide a common API to extract content from multiple providers and provide the flexibility to choose any content provider based upon parameters such as accuracy, availability of content, rates, whether the content is the latest, etc.

The SRC block 306 is a software rendering component which provides multiple channel and device rendering, mobile application provisioning, service creation environment, OSS/BSS integration in both pre-paid and post paid modes, usage analysis reports and SNMP based system management software.

GSC block 308 provides alert and notification systems, personalization, payment integration etc.

Individual services block 310 provides tools and generic components to build individual applications in consumer and enterprise domains. Consumer services like child tracking, buddy location, location based advertisements for target user groups can be built. Enterprise services such as work force management, fleet tracking, emergency services, etc. can use the generic components.

FIG. 32 is a flow diagram of a process a user of a walkie-talkie enabled phone can initiate to join a talk group to enable subsequent walkie-talkie operations. This process greatly simplifies the process of signing up for walkie-talkie operations of a wireless carrier. A user who wishes to join a walkie-talkie talk group launches the TalkControl application, scrolls down to Join Group menu option, selects an Enter Tokens option, fills in her name, phone number, project ID, and Token and presses send. One or more packets are sent to the Rubicon server which authenticates the token and the recipient and creates a database entry. The Rubicon server then determines a time to add the user to the talk group and contacts a server of the wireless carrier to add a user. The Rubicon server logs

onto the Carrier Server and adds the user to the appropriate talk group and receives a confirmation. The confirmation is sent to the user who initiated the process, and the Rubicon server logs out of the carrier server.

FIG. 33 is a flowchart of the process the Rubicon server carries out to automatically delete a user. Users in talk groups can be deleted automatically based upon a scheduled deletion time using this process. The Rubicon (X One) server compares the current date and time with a database for users scheduled to be deleted. If a user is to be deleted per schedule, the Rubicon server logs onto a carrier server and deletes the user from the appropriate talk group and receives confirmation. The Rubicon server then deletes the user from the talk group in its database and logs out of the carrier server. The Rubicon server then sends the deletion confirmation to the user phone.

FIG. 34 is a flowchart of the process the Rubicon server carries out to allow a supervisor to add a user. The supervisor launches the TalkControl application program and scrolls down to the add/edit/delete user menu option and logs in as a supervisor and presses send. The supervisor then selects User Name and selects Next to take him to the user screen where the user's name, phone number, and project ID are entered. The supervisor then edits the start date, end date, hours, days of the week for the active period when the user being added will be part of the talk group so that walkie-talkie service can only be had during the specified times. One or more packets are then generated addressed to the Rubicon server and encapsulated in a cellular system packet and sent. These packets get routed to the Rubicon server which authenticates the initiator and recipient, creates a database entry for the user and contacts the Carrier server and logs on. The Rubicon server then adds the user to the appropriate talk group and receives confirmation. The Rubicon server then adds the user to the appropriate talk group and updates its database and receives the confirmation. The confirmation is sent to the supervisor who added the user and to the user phone which was added to the talk group.

FIG. 35 is a flowchart of the process for a supervisor to edit a user in a talk group. The supervisor launches the TalkControl application and scrolls down to add/edit/delete user and selects that option. The supervisor logs in as the supervisor and selects edit user and selects a user already in a talk group and edits data in fields for name, phone number, project ID of the user to be edited and presses next. Start date, end date, hours, days of the week are then changed as desired. From that point, the process is the same as adding a new user.

FIG. 36 is a flowchart of a process for a supervisor to delete a user from a talk group. The supervisor launches TalkControl and scrolls down to add/edit/delete user and selects that. She logs in as a supervisor and scrolls down to delete a user and deletes data in name, phone number, project ID, start date, end date, hours and days of week field and presses send. One or more packets get routed to the Rubicon servers which authenticates the initiator and recipient. The Rubicon server then logs onto the Carrier server and deletes the user from the appropriate talk group and receives a confirmation. The Rubicon server receives the confirmation and updates its database to delete the user from a talk group. Confirmation is then sent from the Rubicon server to the supervisor phone and the user's phone, and the Rubicon server then logs out of the carrier server.

FIG. 37 is a flowchart of a process for a supervisor to issue a token. The supervisor launches TalkControl and scrolls down to add/edit/delete a user. She logs in as a supervisor and scrolls down to issue token menu option and selects it. She then scrolls down to select project to issue token menu option

and presses next. The user selects token being issued and presses issue. The supervisor then informs the user of the project name and the token code. Packets are sent to the Rubicon server which removes the token from the list and replaces it with a new token. The Rubicon server then sends a message to the supervisor's phone to add the message send new token to the supervisor's handset.

FIG. 38 is a flowchart for the process of setting up preferences. The TalkControl application is launched on the handset and the user scrolls down to the add/edit/delete user option and presses select. The user logs in and presses send. The user then scrolls down to preferences and presses next. The user then selects the preference feature to be updated and presses select. This vectors processing to one of the four illustrated lines of processing to set the methods of notification as audio, vibrate or select auto login or set the new password or set a new ID. Processing then loops back to allow another preference to be selected and edited.

FIG. 39 is a flowchart for the process to allow a supervisor to request status. The supervisor launches TalkControl and scrolls down to view status. She logs in as a supervisor and presses send and then selects a user. The supervisor then scrolls and selects project to view status and presses next and scrolls down to select the project and the user and views the user's details.

FIG. 40 is a process flowchart of the process for a supervisor to create a group. The supervisor launches TalkControl application and scrolls down to create a group and presses select. She then logs in as supervisor and presses send and enters group name. A talk group is then automatically created. The supervisor sets the duration of the group, its start date, end date, days, hours and presses next. One or more packets addressed to the Rubicon server are then created and sent to the Rubicon server. The Rubicon server then authenticates the initiator and recipient and creates a database entry for a new group. The Rubicon server then contacts the carrier server and logs in and creates a talk group in the carrier server and receives a confirmation. The Rubicon server then adds the group to the appropriate talk group and receives confirmation. The confirmation is then sent from the Rubicon server to the supervisor and the Rubicon server logs out of the carrier server. The supervisor phone then receives a message on the wireless device displaying the group added profile updated request screen.

Although the invention has been disclosed in terms of the preferred and alternative embodiments disclosed herein, those skilled in the art will appreciate possible alternative embodiments and other modifications to the teachings disclosed herein which do not depart from the spirit and scope of the invention. All such alternative embodiments and other modifications are intended to be included within the scope of the claims appended hereto.

I claim:

1. An apparatus comprising instructions stored on non-transitory machine readable media, the instructions when executed to cause at least one processor of a cellular wireless device to:

prompt a user of the cellular wireless device, via a user interface of the cellular wireless device, for authorization to establish a relationship with one or more other wireless devices associated with a group code common to said other wireless devices, each other wireless device associated with a respective geolocation; and responsive to authorization provided by the user, determine, from signals received from one or more of the wireless devices having the common group code,

29

proximity of the cellular wireless device to at least one of the corresponding geolocations, transmit information to a network destination via a cellular wireless connection, the information to facilitate identification by the network destination of location of the cellular wireless device relative to the geolocations, receive responsive to identification of the location by the network destination content dependent on the location, and present the content to the user via a user interface of the cellular wireless device; wherein the content includes a map selected dependent on the proximity of the cellular wireless device to the at least one of the corresponding geolocations and the user interface of the cellular wireless device which is to present the content to the user includes an electronic display, and the instructions, when executed, are further to cause the at least one processor to detect a change in the proximity corresponding to a threshold, and dependent thereon, repeat the transmission of information via the cellular wireless connection to the network destination, to thereby facilitate determination of updated position by the network destination of the cellular relative to the geolocations, and visually present the map to the user via the electronic display in a manner that represents a change in position of the cellular wireless device corresponding to the updated position.

2. The apparatus of claim 1, wherein: said instructions are embodied as a mobile device application adapted for selective storage on and installation by the user on the cellular wireless device.

3. The apparatus of claim 1, wherein the instructions when executed are further to cause the at least one processor to: present the map to the user via the electronic display in a manner that shows the position of at least one of the geolocations relative to the cellular wireless device.

4. The apparatus of claim 1, wherein the content includes commercial content, and wherein the instructions when executed are further to cause the at least one processor to: present the commercial content to the user via a user interface of the cellular wireless device.

5. The apparatus of claim 4, wherein the content includes a location-based advertisement, and wherein the instructions when executed are further to cause the at least one processor to: present the location-based advertisement to the user via a user interface of the cellular wireless device.

6. The apparatus of claim 1, wherein the content includes enterprise-specific content, and wherein the instructions when executed are further to cause the at least one processor to: present the enterprise-specific content to the user via a user interface of the cellular wireless device.

7. An apparatus comprising instructions stored on non-transitory machine readable media, the instructions when executed to cause at least one processor of a cellular wireless device to: prompt a user of the cellular wireless device, via a user interface of the cellular wireless device, for authorization to establish a relationship with one or more other wireless devices associated with a group code common

30

to said other wireless devices, each other wireless device associated with a respective geolocation; and responsive to authorization provided by the user, determine, from signals received from one or more of the wireless devices having the common group code, proximity of the cellular wireless device to at least one of the corresponding geolocations, transmit information to a network destination via a cellular wireless connection, the information to facilitate identification by the network destination of location of the cellular wireless device relative to the geolocations, receive responsive to identification of the location by the network destination content dependent on the location, and present the content to the user via a user interface of the cellular wireless device; wherein the instructions when executed are further to cause the at least one processor to detect a change in the proximity corresponding to a threshold, and dependent on the change in proximity, repeat the transmission of information via the cellular wireless connection to the network destination, to thereby facilitate determination of updated position by the network destination of the cellular relative to the geolocations, and receive geospatially-dependent information from the network destination responsive to the updated position.

8. The apparatus of claim 1, wherein the cellular wireless device has an embedded global position system (GPS) position detector adapted to determine position of the cellular wireless device from satellite signals, and wherein the instructions when executed are further to cause the at least one processor to: transmit a GPS position to the network destination as part of the information transmitted to the network destination.

9. The apparatus of claim 1, wherein the instructions when executed are further to cause the at least one processor to: transmit the information to the network destination via the cellular wireless connection via first transmission control/internet protocol (TCP/IP) packets, to receive from the network destination the content via second TCP/IP packets, and to extract the content from the second TCP/IP packets.

10. The apparatus of claim 1, wherein the content comprises a map and a text annotation associated with a first one of the respective geolocations, and wherein instructions when executed are further to cause the at least one processor to: present the map to the user via an electronic display of the cellular wireless device in a manner that shows the text annotation at a position on the map corresponding to the first one of the respective geolocations.

11. The apparatus of claim 1, wherein the instructions when executed are further to cause the at least one processor to: launch an application stored on the cellular wireless device in response to the content.

12. An apparatus comprising instructions stored on non-transitory machine readable media, the instructions when executed to cause at least one processor of a cellular wireless device to: prompt a user of the cellular wireless device, via a user interface of the cellular wireless device, for authorization to establish a relationship with one or more other wireless devices associated with a group code common

31

to said other wireless devices, each other wireless device associated with a respective geolocation; and responsive to authorization provided by the user, determine, from signals received from one or more of the wireless devices having the common group code, proximity of the cellular wireless device to at least one of the corresponding geolocations, transmit information to a network destination via a cellular wireless connection, the information to facilitate identification by the network destination of location of the cellular wireless device relative to the geolocations, receive responsive to identification of the location by the network destination content dependent on the location, and present the content to the user via a user interface of the cellular wireless device;

wherein the instructions when executed are further to cause the at least one processor to receive at least one of a voice recording or a text annotation electively-submitted by the user, and to submit the at least one of the voice recording or the text annotation to the network destination for storage in association with the position of the cellular wireless device.

**13.** An cellular wireless device comprising:  
 at least one processor;  
 memory to store software;  
 circuitry to exchange data with a network via a cellular wireless connection;  
 wherein the software is to cause the at least one processor to  
 prompt a user of the cellular wireless device, via a user interface of the cellular wireless device, for authorization to establish a relationship with one or more other wireless devices associated with a group code common to said other wireless devices, each other wireless device associated with a respective geolocation, and  
 responsive to authorization provided by the user, determine, from signals received from one or more of the wireless devices having the common group code, proximity of the cellular wireless device to at least one of the corresponding geolocations, transmit information to a network destination via a cellular wireless connection, the information to facilitate identification by the network destination of location of the cellular wireless device relative to the geolocations, receive responsive to identification of the location by the network destination content dependent on the location, and present the content to the user via a user interface of the cellular wireless device; and

wherein  
 the content includes a map selected dependent on the proximity of the cellular wireless device to the at least one of the corresponding geolocations, wherein the user interface of the cellular wireless device which is to present the content to the user includes an electronic display, and wherein the software, when executed, is further to cause the at least one processor to visually present the map to the user via the electronic display,  
 the software when executed is further to cause the at least one processor to detect a change in the proximity corresponding to a threshold, and dependent thereon, repeat the transmission of information via the cellular

32

wireless connection to the network destination, to thereby facilitate determination by the network destination of updated position of the cellular relative to the geolocations, and  
 the software when executed is further to cause the at least one processor to visually present the map to the user via the electronic display in a manner that represents a change in position of the cellular wireless device corresponding to the updated position.

**14.** The cellular wireless device of claim **13**, wherein: said software is embodied as a mobile device application adapted for selective activation and deactivation by the user on the cellular wireless device.

**15.** The cellular wireless device of claim **13**, wherein: the software when executed is further to cause the at least one processor to present the map to the user via the electronic display in a manner that shows the position of at least one of the geolocations relative to the cellular wireless device.

**16.** The cellular wireless device of claim **13**, wherein the content includes at least one of commercial content, a location-based advertisement or enterprise-specific content, and wherein:  
 the software when executed is further to cause the at least one processor to present the at least one of commercial content, a location-based advertisement or enterprise-specific content to the user via a user interface of the cellular wireless device.

**17.** The cellular wireless device of claim **13**, wherein: the cellular wireless device has an embedded global position system (GPS) position detector adapted to determine position of the cellular wireless device from satellite signals; and  
 the software when executed is further to cause the at least one processor to transmit a GPS position to the network destination as part of the information transmitted to the network destination.

**18.** The cellular wireless device of claim **13**, wherein: the software when executed is further to cause the at least one processor to transmit the information to the network destination via the cellular wireless connection via first transmission control/internet protocol (TCP/IP) packets, to receive from the network destination the content via second TCP/IP packets, and to extract the content from the second TCP/IP packets.

**19.** The cellular wireless device of claim **13**, wherein the content comprises a map and a text annotation associated with a first one of the respective geolocations, and wherein:  
 the software when executed is further to cause the at least one processor to present the map to the user via an electronic display of the cellular wireless device in a manner that shows the text annotation at a position on the map corresponding to the first one of the respective geolocations.

**20.** The cellular wireless device of claim **13**, wherein the software when executed are further to cause the at least one processor to:  
 launch an application stored on the cellular wireless device in response to the content.

**21.** An cellular wireless device comprising:  
 at least one processor;  
 memory to store software;  
 circuitry to exchange data with a network via a cellular wireless connection;

33

wherein the software is to cause the at least one processor  
to  
prompt a user of the cellular wireless device, via a user  
interface of the cellular wireless device, for authori-  
zation to establish a relationship with one or more  
other wireless devices associated with a group code  
common to said other wireless devices, each other  
wireless device associated with a respective geoloca-  
tion, and  
responsive to authorization provided by the user,  
determine, from signals received from one or more of  
the wireless devices having the common group  
code, proximity of the cellular wireless device to at  
least one of the corresponding geolocations,  
transmit information to a network destination via a  
cellular wireless connection, the information to  
facilitate identification by the network destination  
of location of the cellular wireless device relative to  
the geolocations,  
receive responsive to identification of the location by  
the network destination content dependent on the  
location, and  
present the content to the user via a user interface of  
the cellular wireless device; and  
wherein the software when executed is further to cause  
the at least one processor to detect a change in the  
proximity corresponding to a threshold, and depen-  
dent on the change in proximity, repeat the transmis-  
sion of information via the cellular wireless connec-  
tion to the network destination, to thereby facilitate  
determination of updated position by the network des-  
tination of the cellular wireless device relative to the  
geolocations, and the software when executed is fur-  
ther to cause the at least one processor to receive  
geospatially-dependent information from the net-  
work destination responsive to the updated position.

34

22. An cellular wireless device comprising:  
at least one processor;  
memory to store software;  
circuitry to exchange data with a network via a cellular  
wireless connection;  
wherein the software is to cause the at least one processor  
to  
prompt a user of the cellular wireless device, via a user  
interface of the cellular wireless device, for authori-  
zation to establish a relationship with one or more  
other wireless devices associated with a group code  
common to said other wireless devices, each other  
wireless device associated with a respective geoloca-  
tion, and  
responsive to authorization provided by the user,  
determine, from signals received from one or more of  
the wireless devices having the common group  
code, proximity of the cellular wireless device to at  
least one of the corresponding geolocations,  
transmit information to a network destination via a  
cellular wireless connection, the information to  
facilitate identification by the network destination  
of location of the cellular wireless device relative to  
the geolocations,  
receive responsive to identification of the location by  
the network destination content dependent on the  
location, and  
present the content to the user via a user interface of  
the cellular wireless device; and  
the software when executed is further to cause the at least  
one processor to receive at least one of a voice recording  
or a text annotation electively-submitted by the user, and  
to submit the at least one of the voice recording or the  
text annotation to the network destination for storage in  
association with the position of the cellular wireless  
device.

\* \* \* \* \*